

# Improving the Spectrum Capacity of Optic Fiber Network Using Dense Wavelength Multiplex (DWDM)

Mbah Obinna Kenekwku<sup>1</sup>, James Eke<sup>2</sup>, Alor, M.O<sup>3</sup>.

Electrical and Electronic Engineering Department, Enugu University of Science and Technology (ESUT),  
Enugu, Nigeria.

## Abstract.

This paper is aimed at improving the spectrum capacity of an optic fiber network using dense wavelength division multiplex (DWDM). The motivation was due to the observed ever increasing demand on bandwidth due to the continuous increase in quantity and types data traffic resource on communication networks. To achieve that, an empirical analysis of the network of study was first carried out to evaluate the operational status of the network parameters. It was observed that there were bandwidth capacity issues. A model of dense wavelength division multiplex was developed to increase the capacity of the available bandwidth which was then simulated on the developed SIMLINK model of the network. The results shows that with DWDM scheme the transmission delay in the network was reduced from 85% to 42% resulting in less congestion and improved network throughput for all the network resources. Hence, dense wavelength division multiplex is a good technique for improving the capacity of optic fiber network without tampering with the network infrastructure.

**Keywords:** Spectrum capacity, delay, bandwidth, WDM, DWDM, throughput

Date of Submission: 09-05-2022

Date of Acceptance: 24-05-2022

## I. Introduction

Fiber optics is a medium for carrying information from one point to another in the form of light. Unlike the copper wire and coaxial cable form of transmission, fiber optics transmission is not electrical in nature. A basic fiber optic system consists of transmitting devices that converts an electrical signal into a light signal, an optical fiber cable that transmits light signal, and a receiver that accepts the light signal and converts it back into an electrical signal at the destination. The complexity of a fiber optic system can range from very simple (i.e., local area network) to extremely sophisticated and complex network (i.e., long distance telephone or cable television trunking). For example, the system shown in Figure 1 could be built very inexpensively using a visible LED, plastic fiber, a silicon photo detector, and some simple electronic circuitry to transmit information from one point to another (Friberg, 2010) which can be improved to transmit a huge amount of information.

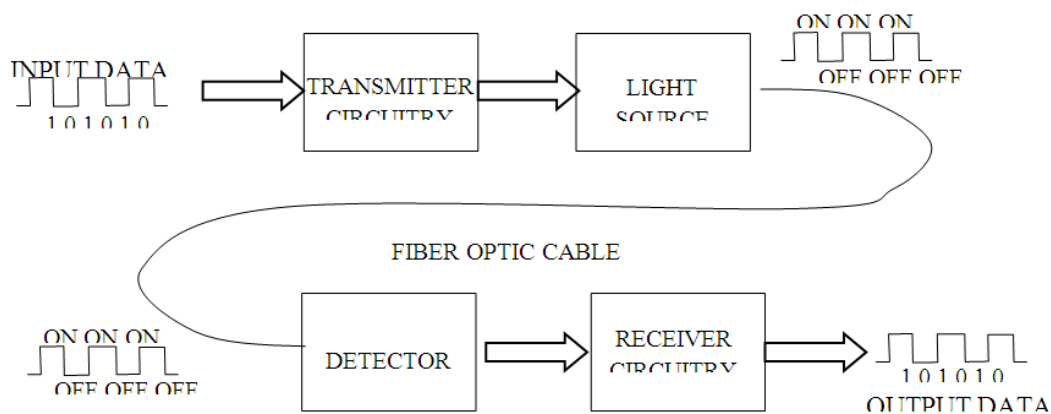

Figure 1: A simple optical fiber transmission system

The advances in data communication and information technology allow tremendous amounts of data to be transferred through the optic fiber networks if it is supported by high bandwidth optical fiber and also the emergence of fast computer processors, which speed are increasing every day. As a result, all business activities which require high data bandwidth such as video on demand, video conferencing, digital photography and

others can be conveniently realized. In recent times, the required network capacity increases exponentially, which gives an indication that Tbit/s capacity is not far from reality. Future technologies such as Fiber-To-The-Premise (FTTP) and Fiber-To-The-Home (FTTH) which deploy the fiber up to the consumer premises are being considered seriously as an alternative to satisfy bandwidth demand (Wood, 1999).

Since the first deployments of fiber-optic communication systems three decades ago, the capacity carried by a single-mode optical fiber has increased tremendously. Network traffic has increased by a much higher factor, but with most of the growth occurring in the last few years, when data started dominating network traffic. The large difference in growth rates between the delivered fiber capacity and the traffic demand is creating capacity shortage within the network. This has resulted in congested network leading to poor quality of service and higher packet drops in the network (Shilpa et al, 2015). This brings about failures in data, video and voice services delivery to customers which has translated to huge financial losses to customers who depend on fiber optics network for their business transactions.

There was therefore great need to increase the network capacity to accommodate these growing demands.

## II. Thoery Of Work

Optical communications system underwent a revolution in the 1990s as optical amplifiers and wavelength division multiplex (WDM) enabled the information carried on a single fiber to move from a few gigabits per second to over one terabit per second (Kogelnik, 2010). This rapid expansion of system capacity is demonstrated in Fig.2. The points on the figure are total capacities for a single fiber in laboratory/research demonstrations. Points are also distinguished by whether WDM is employed. Generally, only points which represent a new record of capacity are plotted. Various time periods exhibit relatively stable growth rates with relatively sharp demarcations between them. An initial rapid rise in capacity for single channel time division multiplexing (TDM) is demonstrated as researchers employed available microwave components in digital circuits. Progress levels-off in the late 1980s as the optical system speed became limited by the speed of components and further progress was controlled by the rate of technological development of transistors.

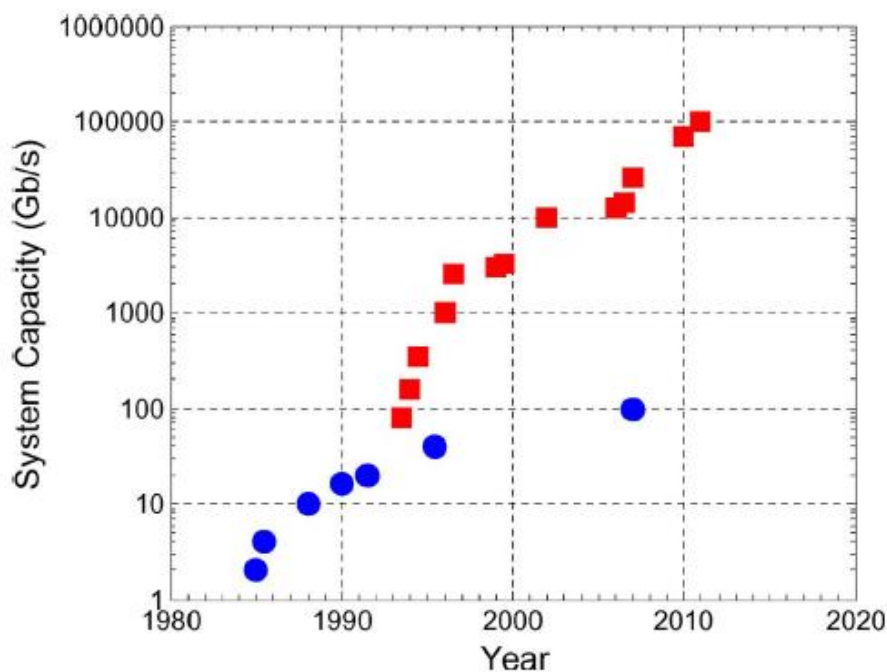

Figure 2: Demonstrated system capacities. Single channel TDM systems (filled circles) WDM systems (filled squares) (Kogelnik, 2010).

Another rapid rise in capacity begins in 1993 when the availability of optical amplifiers, dispersion management, and gain equalization enabled the application of WDM. The available spectrum was rapidly populated by more channels until 1996, when the spectrum was nearly filled, and the first 1 Tb/s experiments were being performed (Gnauck, 2004). From this time until the present, a slower rate of capacity increase is observed as research focused on increased spectral efficiency (SE). Fig.3 shows the SE achieved in these demonstrations as a function of year. It is clear from the figure that improvements in SE have driven the improvements in capacity.

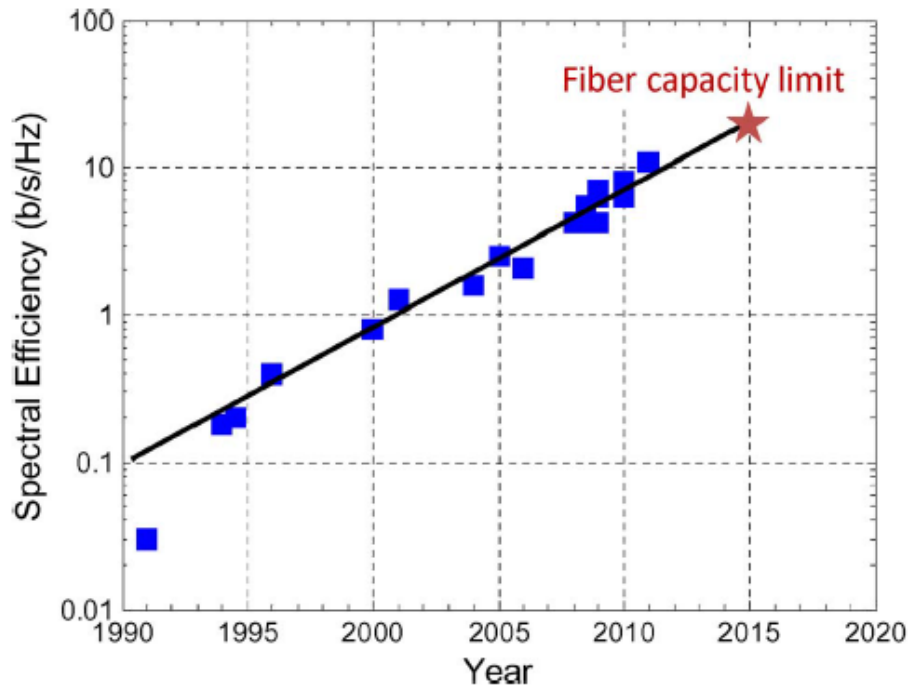

Fig.3: Spectral efficiency achieved in research demonstrations versus year (Essiambre, 2010).

The current capacity record of 101.7 Tb/s achieved a SE of 11 b/s/Hz (Qian, 2011) using coherent detection, offline processing and pilot tone-based phase-noise mitigation. The modulation format is quadrature amplitude modulation (QAM) with 128 constellation points (128-QAM). The signal-to-noise ratio required for this format, combined with the limitations imposed by impairments arising from optical fiber nonlinearity, allowed transmission over only three relatively short, Raman-amplified spans. The SE of this result is impressive and it is worth noting that improving it by a factor of two via a more complex constellation would require the use of 16 384-QAM and would increase the required optical signal-to-noise ratio (OSNR) by about two orders of magnitude making transmission over useful distances impossible given the presence of nonlinear effects in fibers. Fig.4 shows the capacity of commercial optical communication systems as a function of the year of introduction.

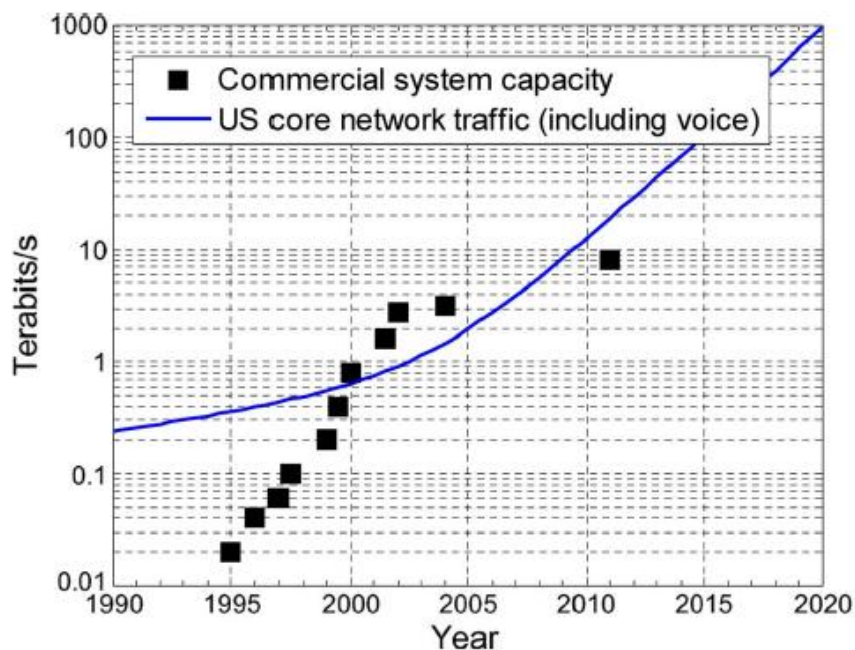

Fig.4: Commercial system capacities (squares) and total network traffic including voice (blue curve) (Kogelnik, 2010).

These tend to track the research demonstrations of Fig. 3 with a three to seven year delay. The point at 8.8 Tb/s in late 2009 corresponds to a system with 88 100-Gb/s channels using polarization-multiplexed QPSK modulation and coherent detection. The solid lines in Fig.4 provide a continuous representation of system capacity vs. year and are projected into the future. The slope of the line from 2000 forward corresponds to a growth rate of less than 20% per year. The curve in Fig.4 is the composite network traffic composed of the data traffic extrapolation described above combined with voice traffic which dominated the network before 2002 but grows slowly. Notice that the total network traffic and system capacity crosses twice. First, in 2000, commercial system capacity increases through the total network traffic and it became possible to buy a system that could carry the entire network traffic on a single fiber pair. Second, the two curves cross again in 2008, when traffic growth resulted in network traffic exceeding system capacity. In the following years the projected curves diverge with traffic outstripping capacity by more than a factor of 10 per decade.

It is important to note that there is no obvious reason to compare network traffic with the capacity of a single optical communication system; however, the comparison can be justified, at least when plotted on a logarithmic axis. The capacity of a link must obviously be larger than the traffic carried on that link; typically the factor is between two and five, accounting for peak to average traffic ratios (Roughan, 2012). Of course, the traffic on a link is not the same as the traffic in the network. In North America for example there are three to five links passing east to west, so we might expect that link traffic would be roughly three to five times lower than network traffic. These two errors are in opposing directions and one may hope that the comparison carries at least qualitative and order-of-magnitude value.

As system capacity scales to meet the growth of network traffic, it is important for the speed of interface rates to the networking equipment to increase as well in order to limit the increase in complexity of the network. Fig.5 shows interface rates for a variety of networking equipment plotted against the year of commercial introduction. The plot starts with an early high-speed interface at 168 Mb/s through today (Roughan, 2012).

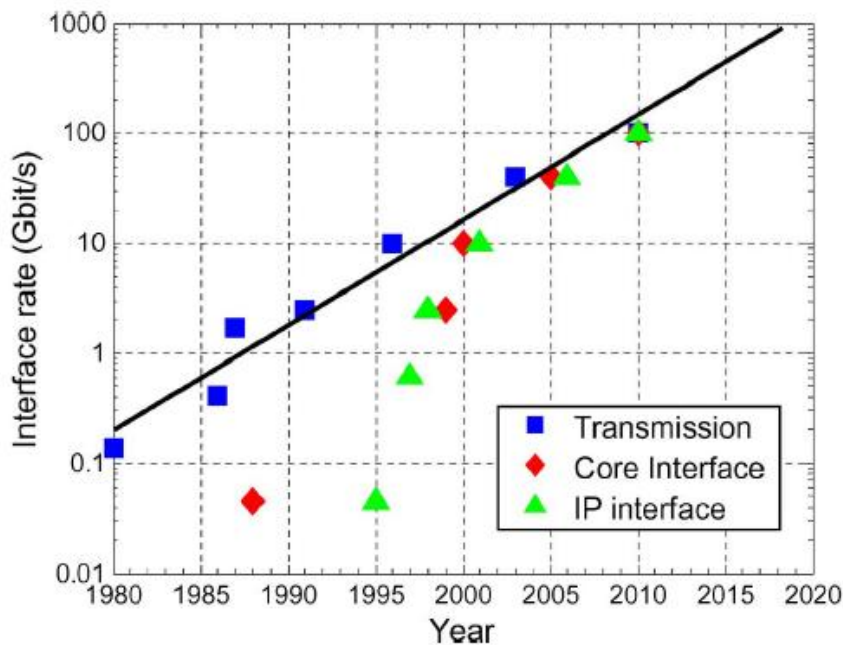

Fig.5: Interface rates for a variety of networking equipment versus year of introduction. Optical communication systems (squares), cross connects (diamonds), and IP routers (triangles) (Roughan, 2012).

The years before 2000 are characterized by a variety of rates for various layers of the network, with cross connects and internet protocol (IP) routers using lower rates than those available for transmission. In 2000, we see a remarkable coalescing of rates at 10 Gb/s for transmission, cross connects, and routers. While this plot overstates the case, since interfaces introduced in earlier years persist in the network, it is clear that there has been a substantial flattening of the network; the utility of low bit rate circuits and the network elements that provision them becomes marginal as interface rates to nodal equipment rise. The line on the graph is drawn through the transmission points and attempts to project the evolution of interface rates into the next decade. This extrapolation suggests that 1-Tb/s interfaces will be used towards the end of the decade. The slope of the line is roughly a factor of 10 in 10 years - similar to that seen for the extrapolation of system capacity. Thus far we have only examined trends and extrapolated their continuation.

Now attention will be turned to the requirements that these trends in traffic and capacity will place on system design. It begins by reviewing the evolution of some key system parameters. The earliest WDM systems had between four and eight 2.5-Gb/s channels and were introduced in 1995. These first systems had capacities on the order of 20 Gb/s and operated on a 200-GHz channel spacing resulting in a SE of 0.0125 b/s/Hz. By 2000, systems had rapidly advanced to 80 or more 10-Gb/s channels operating on 50-GHz spacing for capacities of nearly 1 Tb/s, and a SE of 0.2 b/s/Hz. Commercial systems introduced in 2010 operate with 100-Gb/s channels on 50-GHz spacing with SE of 2.0 b/s/Hz. To obtain the same factor of 10 improvements over the next decade would imply systems with 1-Tb/s channels, capacity of 100 Tb/s, and SE of 20 b/s/Hz. Clearly these are very challenging specifications. In fact, further increase in capacity will be hampered by significant limitations arising from fiber increasing nonlinearity and increasing evolving new network packets. Hence the need to explore the use of dense wavelength division multiplex which will take care of the new increases and there non linearity nature.

### III. Methodology

#### (a) Characterization of the Network of Study

The key performance indicator for this study is the delay (latency) experienced in the Network by various types' network resource. According to Deepth Prakash and Sadahivappa (2020), when a fiber network is congested it normally manifest in form of delays. Data packets in a congested network experience various forms of delay according to the type of packet. Therefore an empirical study of the network of study was conducted to evaluate the status of network parameters that should necessitate capacity expansion. Data was therefore collated from the daily operational record of the network of study for a period of three months. The result of the study is shown in table 1.

**Table1:** Result of the empirical study of the network (delay/latency experienced by different packets in the network)

Time\Packets	Delays				
	Audio (μsecs/km)	Data (μsecs/km)	Video (μsecs/km)	FTP (μsecs/km)	JPEG (μsecs/km)
6.00-6.30am	252.8	120.50	140.22	265.80	280.22
7.00-7.30am	214.20	118.20	100.98	211.20	223.40
8.00-8.30am	205.40	109.13	85.26	202.40	200.57
9.00-9.30am	286.10	115.52	115.75	220.40	210.60
10.00-10.30am	292.50	119.14	120.88	224.44	215.75
11.00-11.30am	282.45	118.74	126.91	232.78	219.10
12.00-12.30pm	200.51	114.25	115.23	241.22	220.00
1.00-1.30pm	300.17	100.20	98.20	201.20	102.50
2.00-2.30pm	292.78	99.01	90.25	199.75	105.70
3.00-3.30pm	198.20	172.10	90.22	176.50	103.21
4.00pm-4.30pm	192.40	170.20	87.24	170.11	102.77
5.00pm-5.30pm	112.23	165.10	69.29	164.23	99.78
6.00pm-6.30pm	102.45	150.5	57.33	160.11	87.42
7.00pm-7.30pm	115.50	149.25	55.23	153.22	88.23
8.00pm-8-30pm	200.25	151.32	65.23	160.27	90.21
9.00pm-9.30pm	232.11	182.10	72.11	162.88	95.45
10.00-10.30pm	250.22	178.50	80.23	198.25	189.55

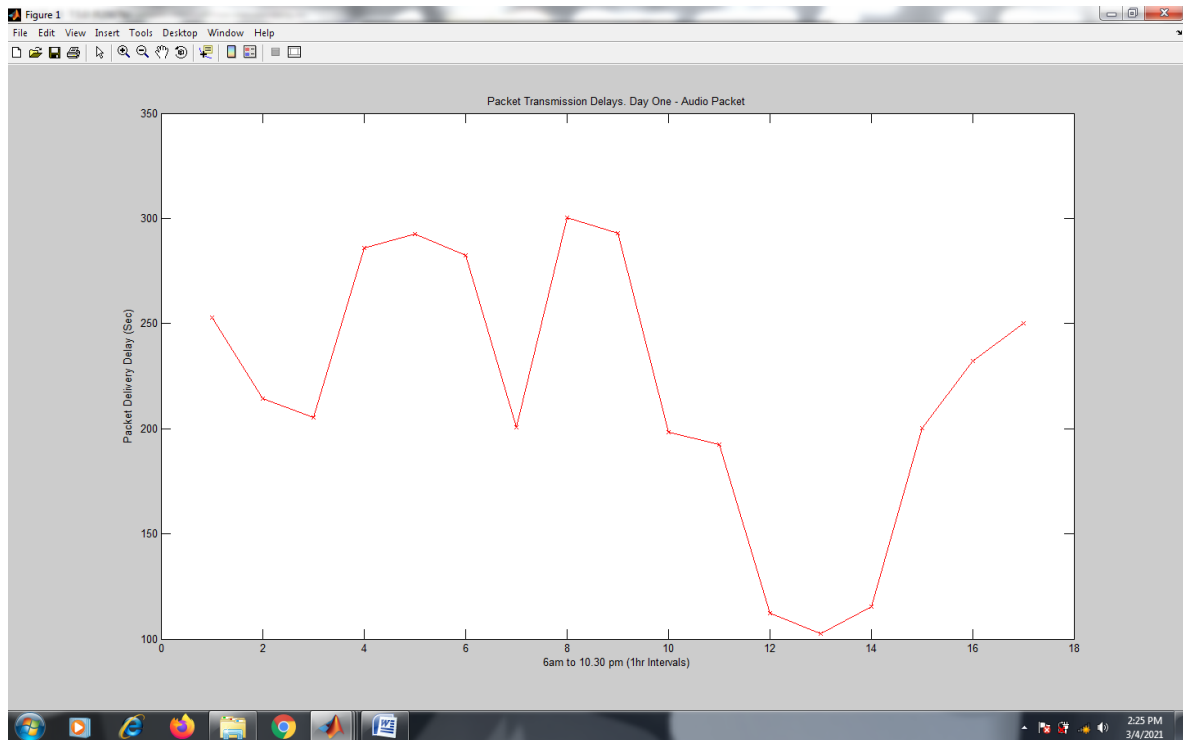

Fig.6: Effect of transmission delay on audio packets.

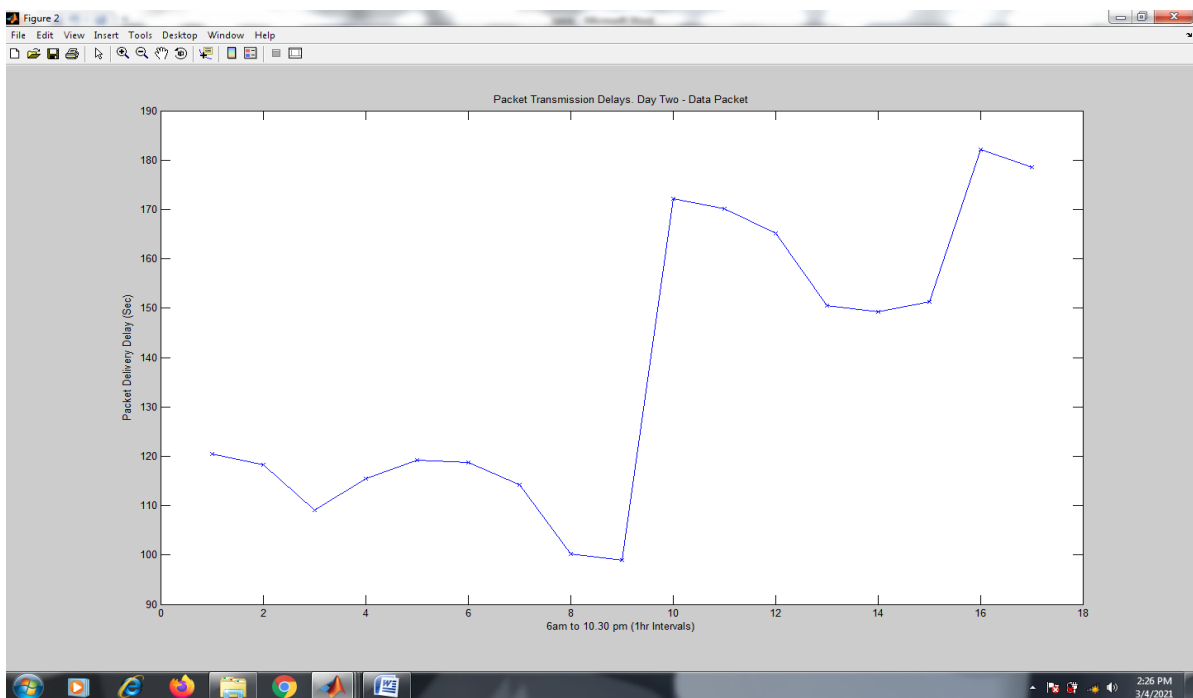

Figure 7: Effect of transmission delay on data packets

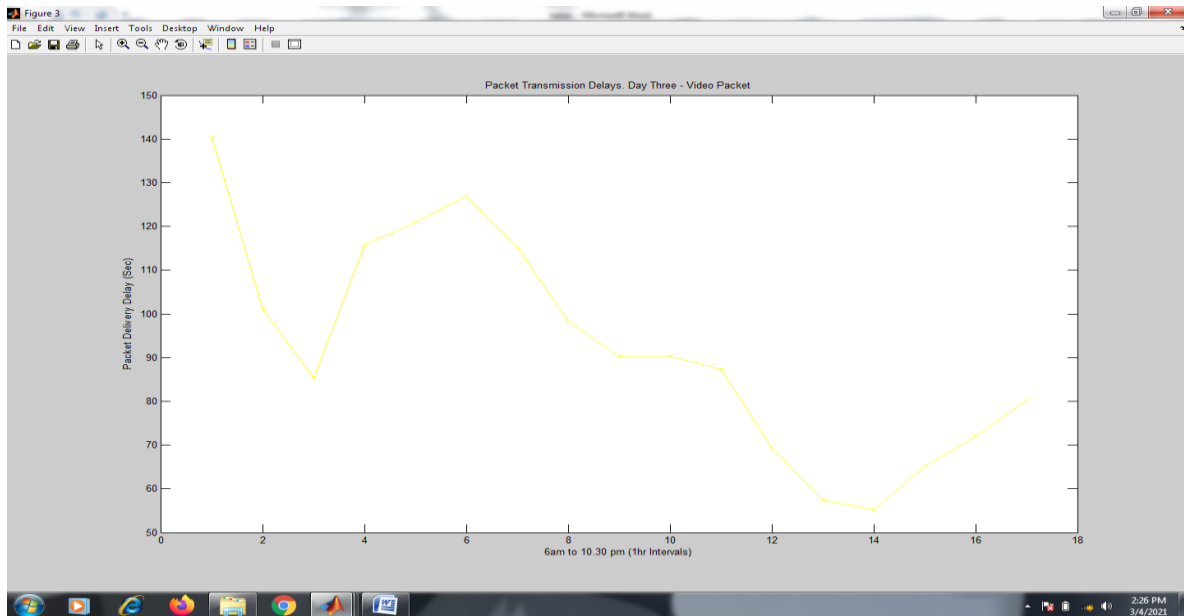

Figure 8: Transmission delay in video packets

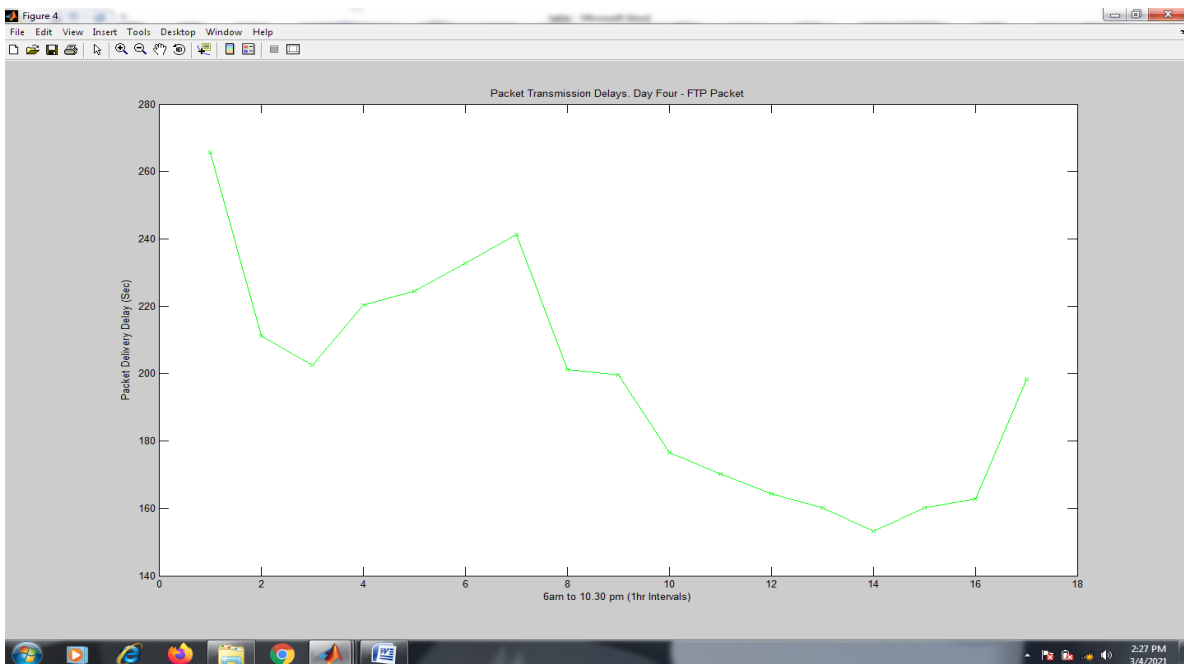

Fig. 9: Effect of transmission delay on FTP packets

Analysis of the data collated as shown in Figs. 6 to 9 shows clearly that there was serious delay in the network especially during the busy hours indicating a very serious congestion problem on the network. These delays do manifest in call drops, low throughput and other transmission issues. Such development demands increase in the network capacity, which was achieved by software means using dense wavelength division multiplexing (DWDM).

**(b) Development of a model for DWDM scheme**

Dense wavelength division multiplexing (DWDM) is a fiber-optic transmission technology that multiplexes many different wavelength signals from different sources for transmission in a single fiber. In this process each fiber has a set of parallel optical channels and each one uses slightly different light wavelengths from the other.

Dense Wavelength Division Multiplexing (DWDM) is used to increase bandwidth over existing fiber networks. DWDM works by combining and transmitting multiple signals simultaneously at different

wavelengths on the same fiber. The effect of this process is that one fiber is transformed into multiple virtual fibers capable of carrying huge amount of data.

In this work, five different packets (Audio, Data, Video, FTP and JPEG) were multiplex using slightly different wavelengths that suits each of the packets and then transmitted simultaneously using a single fiber as shown Figure 10.

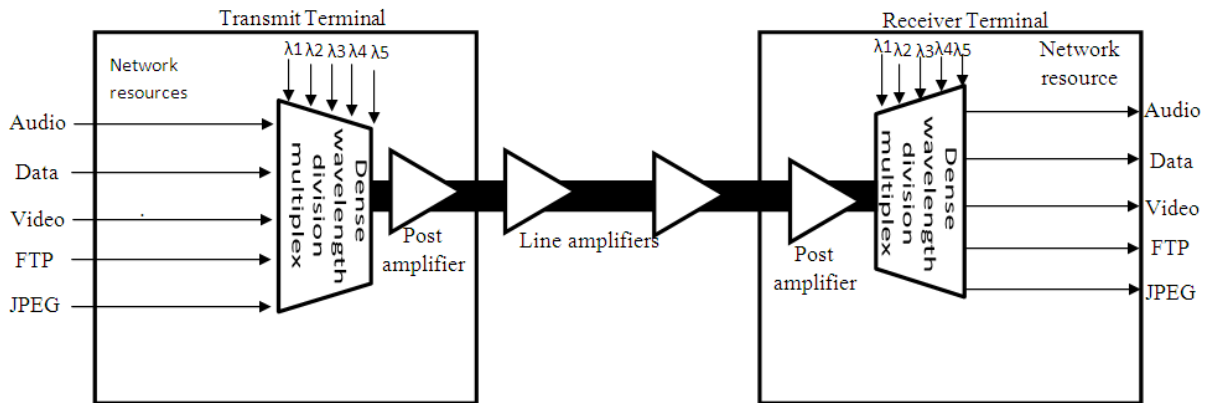

Fig.10: Dense wavelength division multiplex scheme for improving the bandwidth capacity

In Fig.10 the incoming signals are signals from different resources going into DWDM system where various wavelengths are generated to modulate and then multiplex the signals for transmission. At the receiving end a reverse process is undertaken to separate the various resources at the demultiplexer.

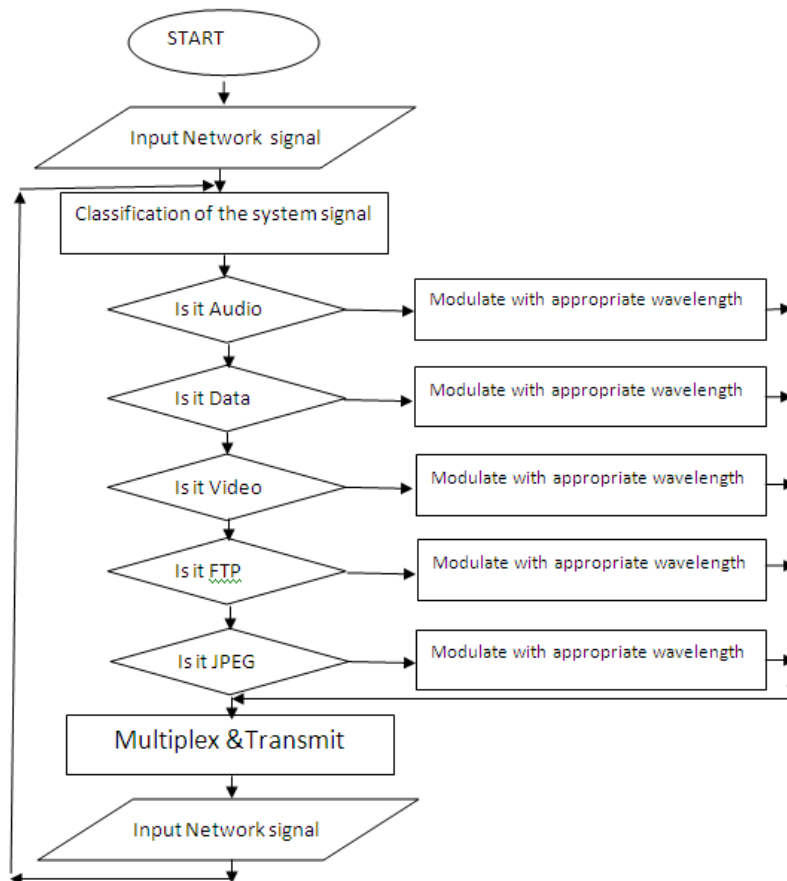

Fig. 11: Flowchart of DWDM scheme for increasing the system capacity

From the Fig.11 the system receives the network signal. The various packets are then identified. Different wavelengths are generated depending on the type of resource. The generated packets are used to modulate the network signal. The wavelength modulated signals are then multiplexed and transmitted.



(c) SIMULATIONS

The SIMULINK platform for the simulation experiments to evaluate the effect of dense wavelength multiplexing on the network traffic is shown Figure 12.

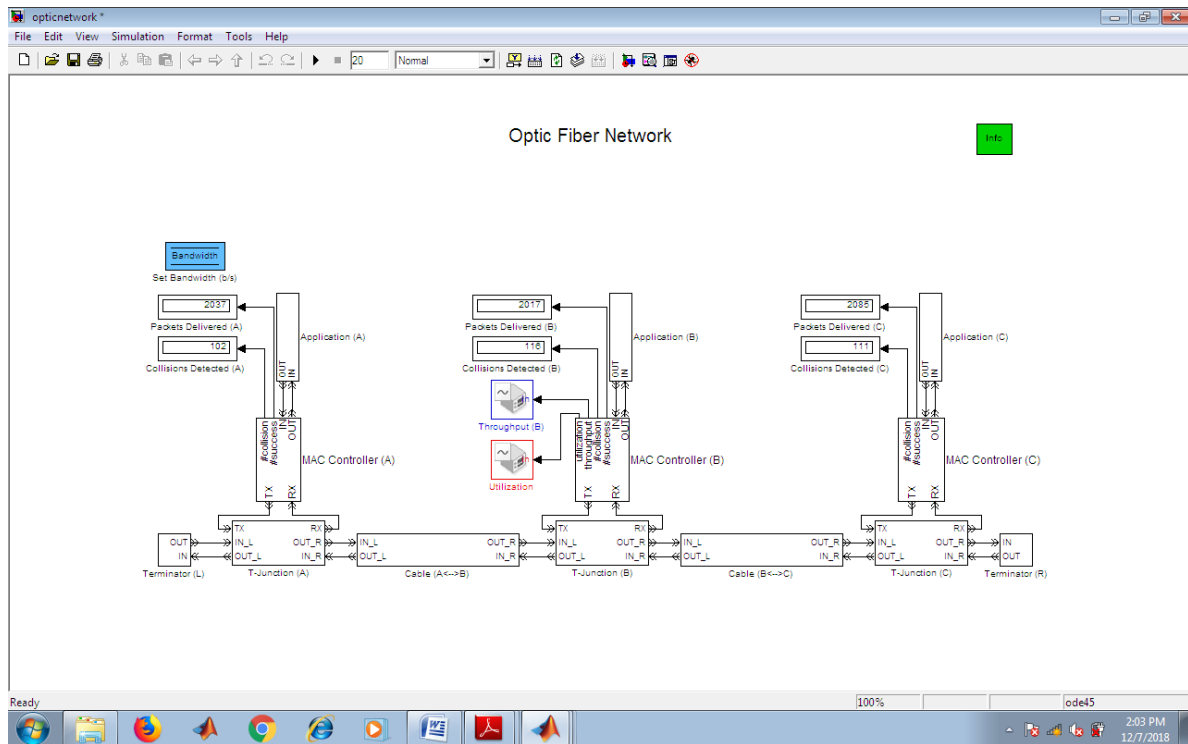

Fig.12: SIMULINK platform for Simulations experiments

IV. Result

Table 2: Simulation results of the effect of DWDM scheme on transmission delays experienced by various packets

Time \ Packets	Audio (µsecs/km)	Data (µsecs/km)	Video (µsecs/km)	FTP (µsecs/km)	JPEG (µsecs/km)
6.00-6.30am	176.96	74.82	87.22	208.31	212.10
7.00-7.30am	149.08	68.31	71.12	200.02	190.36
8.00-8.30am	143.7	69.81	72.25	180.123	150.05
9.00-9.30am	200.01	70.213	77.43	199.61	160.43
10.00-10.30am	203.72	71.842	80.21	198.45	163.31
11.00-11.30am	197.705	72.14	82.05	200.423	163.34
12.00-12.30pm	141.357	76.60	74.78	199.45	164.17
1.00-1.30pm	208.113	69.23	72.03	180.123	73.50
2.00-2.30pm	204.946	68.43	71.43	178.24	74.14
3.00-3.30pm	135.65	120.43	70.23	152.24	72.98
4.00pm-4.30pm	142.6	118.12	60.23	151.6	70.21
5.00pm-5.30pm	78.561	113.34	70.45	107.34	69.05
6.00pm-6.30pm	71.31	114.50	40.21	106.12	68.56
7.00pm-7.30pm	80.24	96.34	38.45	100.95	65.65
8.00pm-8-30pm	149.72	76.12	42.05	98.41	66.21
9.00pm-9.30pm	193.21	74.32	48.63	100.56	61.02
10.00-10.30pm	174.14	123.65	155.132	138.234	131.45

Table 3: Comparison of characterized and simulated results of the transmission delay experienced by the five different network resources.

Time\ Packets	Delays									
	Audio (µsecs/km)		Data (µsecs/km)		Video (µsecs/km)		FTP (µsecs/km)		JPEG (µsecs/km)	
	Charac- terized	Simulate d	Charac- terized	Simulat ed	Charac- terized	Simulat ed	Charact erized	Simulat ed	Charac- terized	Simulat ed
6.00-6.30am	252.8	176.96	120.50	65.09	140.22	87.22	265.80	189.56	280.22	212.10
7.00-7.30am	214.20	149.08	118.20	59.43	100.98	71.12	211.20	180.58	223.40	190.36
8.00-8.30am	205.40	143.7	109.13	60.73	85.26	72.25	202.40	163.91	200.57	150.05
9.00-9.30am	286.10	200.01	115.52	61.09	115.75	77.43	220.40	181.65	210.60	160.43
10.00-10.30am	292.50	203.72	119.14	62.50	120.88	80.21	224.44	180.59	215.75	163.31
11.00-11.30am	282.45	197.71	118.74	62.76	126.91	82.05	232.78	182.38	219.10	163.34
12.00-12.30pm	200.51	141.36	114.25	66.64	115.23	74.78	241.22	181.50	220.00	164.17
1.00-1.30pm	300.17	208.11	100.20	60.23	98.20	72.03	201.20	163.91	102.50	73.50
2.00-2.30pm	292.78	204.95	99.01	59.53	90.25	71.43	199.75	162.20	105.70	74.14
3.00-3.30pm	198.20	135.65	172.10	104.77	90.22	70.23	176.50	138.54	103.21	72.98
4.00pm-4.30pm	192.40	142.6	170.20	102.76	87.24	60.23	170.11	137.96	102.77	70.21
5.00pm-5.30pm	112.23	78.561	165.10	98.61	69.29	70.45	164.23	97.68	99.78	69.05
6.00pm-6.30pm	102.45	71.31	150.5	99.62	57.33	40.21	160.11	96.57	87.42	68.56
7.00pm-7.30pm	115.50	80.24	149.25	83.82	55.23	38.45	153.22	91.86	88.23	65.65
8.00pm-8.30pm	200.25	149.72	151.32	66.22	65.23	42.05	160.27	89.55	90.21	66.21
9.00pm-9.30pm	232.11	193.21	182.10	64.66	72.11	48.63	162.88	91.51	95.45	61.02
10.00-10.30pm	250.22	174.14	178.50	107.58	80.23	58.76	198.25	125.79	189.55	131.45

V. Comparative Analysis And Discussions

Analysis

(a) Comparison of characterized and simulated delay on audio packets

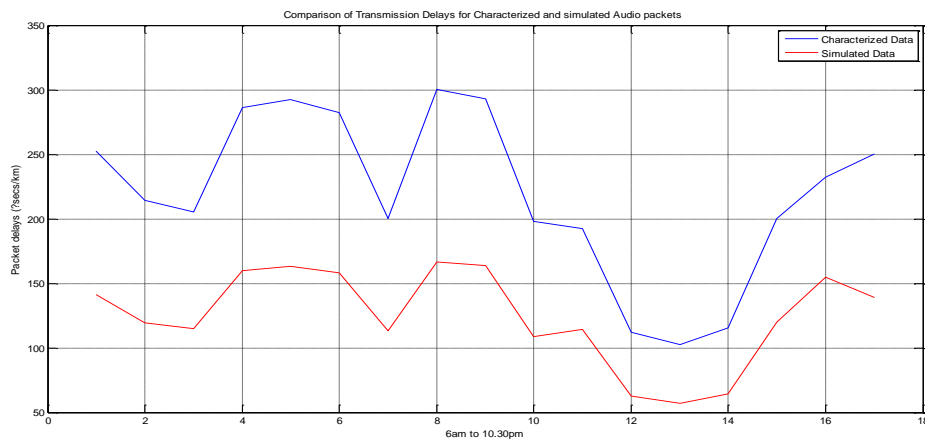

Fig.13: Analysis of the characterized and simulated results of delay on audio packets

Fig.13 shows clearly that there is a very significant reduction in the transmission delay with the application of DWDM scheme as can be observed from the wide gap between the characterized and simulated results.

**(b) Comparison of the characterized and simulated delay on data Packets**

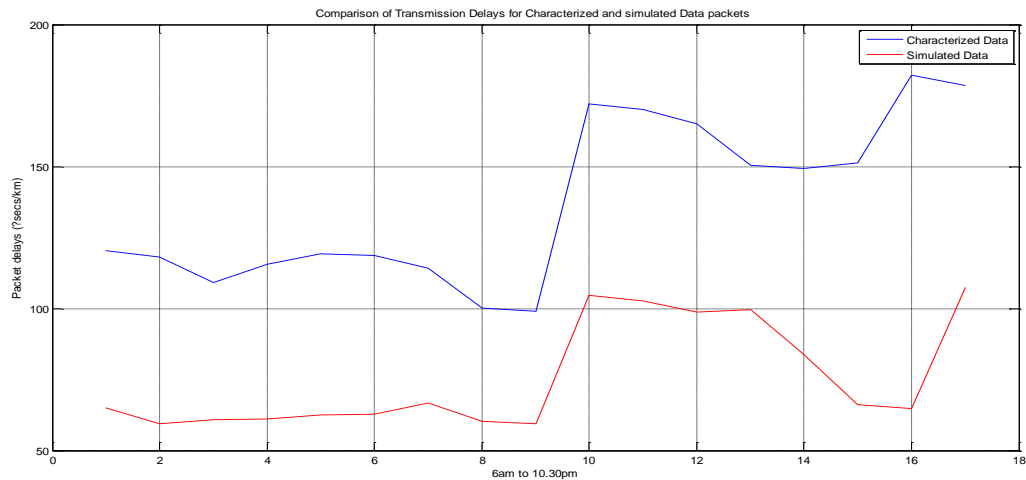

Fig.14: Analysis of the characterized and simulated results of delay on data packets

From Fig.14 the reduction of transmission delay by the DWDM scheme is demonstrated by the wide gap between the characterized and simulated results. There was a significant reduction in the simulated result though not as in audio resource.

**(c) Comparison of characterized and simulated Delay on video Packet**

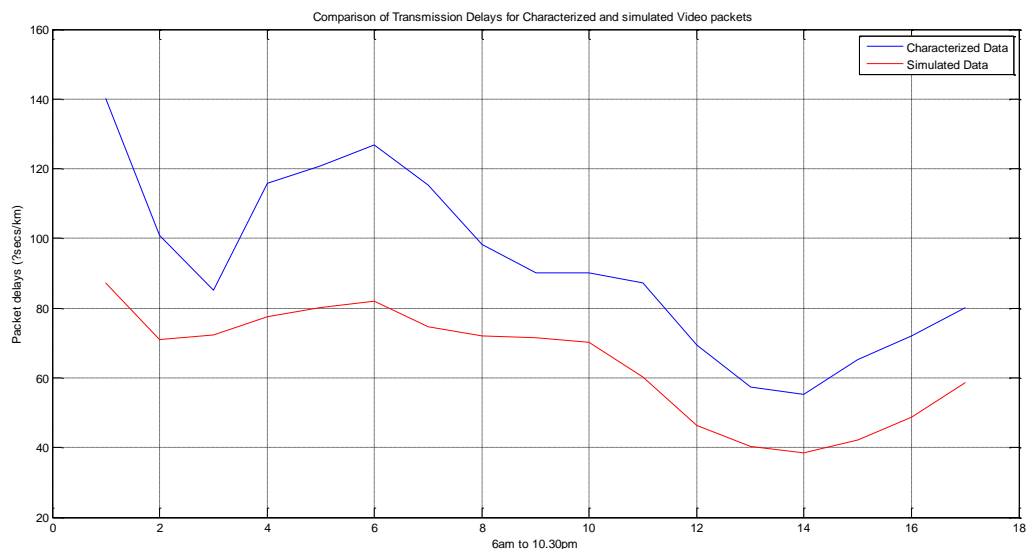

Fig.15: Analysis of the characterized and simulated results of delay on video packets

From Fig. 15 it can be observed that there is a significant reduction on video packet transmission delay with application of the DWDM scheme. But the effect is not as on the audio packets.

**(d) Comparison of the characterized and simulated Delay on FTP Packet**

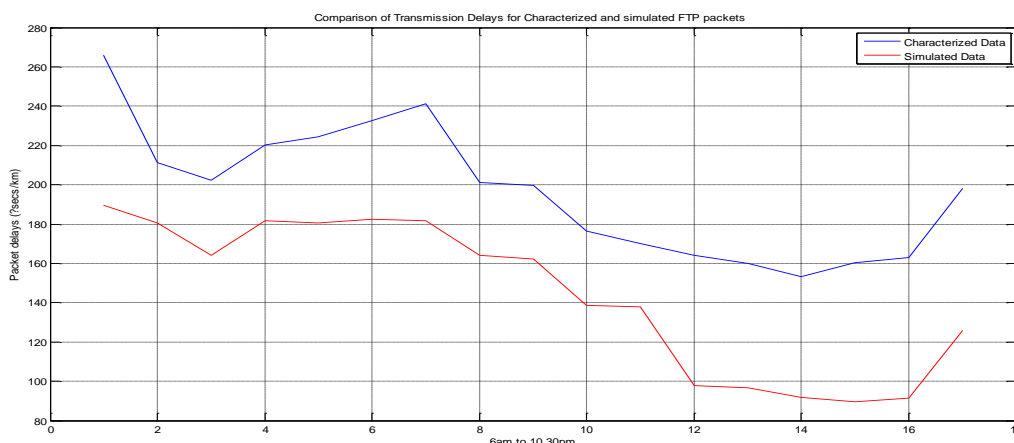

Fig: 16: Analysis of the characterized and simulated results of delay on FTP packets

As can be seen in Fig.16, the simulated result shows a very significant reduction of transmission delay on FTP packets because of the improved bandwidth brought about by the DWDM scheme in the system.

**(e) Comparison of the characterized and simulated Delay on JPEG Packet**

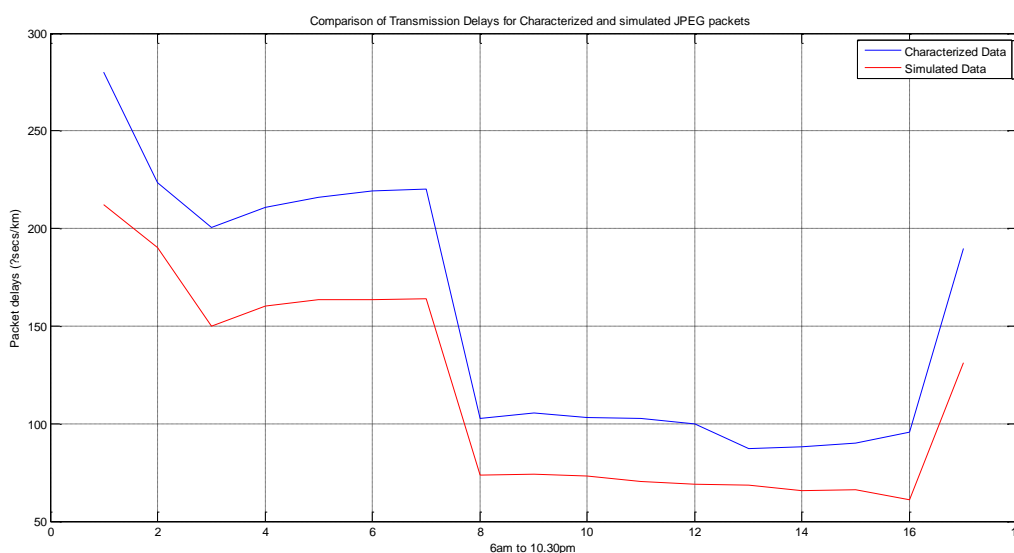

Fig.17: Analysis of the characterized and simulated results of delay on JPEG packets

The analysis in Fig. 17 shows that there is slight reduction of transmission delay with the application of DWDM scheme, but the effect of the reduction is not as much as in other packets

**VI. Discussion**

Dense wavelength division multiplex (DWDM) scheme has been shown to reduce network signal delay significantly, but the reduction affects the network resources differently according to the type of resource. Hence for this work, the scheme reduces the delay most in audio packets, data packets, FTP packets, video and JPEG packets accordingly.

**VII. Conclusion**

The results has shown that DWDM will continue to improve bandwidths in optical networks and hence enable the system to transmit large amounts of data even from different sources. In fact, with the DWDM scheme as demonstrated in this work, the capacity of optic fiber systems will grow as technologies that allow closer spacing, and therefore higher numbers of wavelengths advances. This is predicted to enable DWDM to also move beyond transport to become the basis of all-optical networking with wavelength provisioning and

mesh-based protection. With the DWDM Model for example, the capacity of the GSM network that uses fiber optics networks as its backbone will improve greatly resulting to less congestion which is the major cause of call drops in the system.

### References

- [1]. Deepthi Prakash and Sadashivappa G. (2020) " Enhancing the Capacity of DWDM Optical Network - A Survey " , International Journal of Electrical, Electronics and Data Communication (IJEEDC), pp. 13-17, Volume-8,Issue-2
- [2]. Essiambre, R.-J., Kramer, G., Winzer, P. J., Foschini, G. J., and Goebel, B., (2010) "Capacity limits of optical fiber networks" J. Lightw. Technol., vol. 28, pp. 662–701.
- [3]. Friberg, A. and Yimo, Z. (2010), "Chromatic dispersion compensation in coherent transmission system using digital filters". Optics Express 16243, Vol.18, No. 15
- [4]. Kogelnik, H., (Nov./Dec. 2010) "High-capacity optical communications: Personal recollections," IEEE J. Sel. Topics Quantum Electron, vol. 6, no. 6, pp. 1279–1286,
- [5]. Qian, D., Huang, M., Ip, E., Huang, Y., Shao, Y., Hu, J., and Wang, T., (2011), "101.7-Tb/s (370 294-Gb/s) PDM-128QAM-OFDM transmission over 3 55-km SSMF using pilot-based phase noise mitigation,[ presented at the Opt. Fiber Commun" Conf. (OFC), , Paper PDPB5.
- [6]. Roughan, M., Greenberg, A., Kalmanek, C., Rumsewicz, M., Yates, J., and Zhang, Y., (2012) BExperience in measuring backbone traffic variability: Models, metrics, measurements and meaning" in Proc. 2nd ACM SIGCOMM Workshop Internet Measure. (IMW '02). ACM, , pp. 91–92
- [7]. Shilpa Sharma, Vikrant Sharma, Dr. Dalveer Kaur (2015) "Review paper on DWDM technology", European Scientific Journal October 2015 /special/ edition Vol.2 ISSN: 1857 – 7881 (Print) e - ISSN 1857- 7431 102
- [8]. Wood, T. H., Wilson, G. C., Feldman, R. D., and Stiles, J. A., (1999) "FiberVista: A Cost- Effective Fiber-to-the-Home (FTTH) System Providing Broad-Band Data Over Cable Modems Along with Analog and Digital Video", IEEE Photon. Technol. Lett., Vol.11 , No.4 , pp. 475-477

Mbah Obinna Kenechukwu, et. al. "Improving the Spectrum Capacity of Optic Fiber Network Using Dense Wavelength Mulitplex (DWDM)." *IOSR Journal of Electronics and Communication Engineering (IOSR-JECE)* 17(3), (2022): pp 11-23.