

Remote Monitoring System For Independent Power Stations In Rural And Mountainous Areas In Vietnam

NGO Phuong Le, LUONG Ngoc Giap,
NGUYEN Binh Khanh, BUI Tien Trung, TRUONG Nguyen Tuong An
Institute of Energy Science, Vietnam Academy of Science and Technology
A9 Building, 18, Hoang Quoc Viet str., Cau Giay dist., Hanoi, Vietnam
Corresponding Author: NGO Phuong Le

Abstract: *The paper presents the research results of building a remote monitoring system of independent power stations in rural and mountainous areas in Vietnam, where there is no electricity and telephone reception. Wireless communication technologies were considered and LoRa was chosen. Monitoring system model includes monitoring station at independent power station and remote monitoring station. At the independent power stations, power parameters are measured for on-site display and sent via the LoRa protocol to the central monitoring station. The central station receives signals from independent stations and displays the operating status of these stations. Experimental models were built and tested in Vietnam Academy of Science and Technology.*

Keywords: *LoRa, independent power station, IoT, LPWAN, LoRaWAN.*

Date of Submission: 16-06-2020

Date of Acceptance: 02-07-2020

I. Introduction

At present, many rural areas in Vietnam still aren't connected to the national electricity grid, especially in mountainous and remote areas. One of the current solutions is to build independent solar power stations (possibly with batteries) to supply electricity to each household.

However, the operation monitoring, incident detection and repair of these power stations face many difficulties due to the following reasons:

- Weak mobile signal or no reception;
- Remote and complex mountainous terrain;
- Scattered population, villages separated by mountains;

With the above characteristics, a remote monitoring and warning system to support the management and safe use of electricity for independent solar power station was proposed as following:

- At each independent household power station (HPS), a monitoring device is installed to monitor the operation of the independent electricity supply system and transmit information to the center.
- Each district has a central monitoring station (CMS) in the center of the district (or other convenient location), to collect data from HPS, helping to monitor the operation and detect incidents.

In order to transmit information to the center, because the area does not have telephone reception, the system can use radio transmitters at 315, 433, 868 and 915MHz. These are frequencies that do not require licensing, so the hardware to build the system is already available on the market to help development and deployment faster. According to Vietnam's Circular 1/VBHN-BTTTT dated Mar 3rd 2019, this communication equipment can be classified as a radio telemetry device and allowed to use the 433 MHz band without license if the generating capacity less than 100mW.

II. Overview Of Wireless Technologies

Media solutions for remote monitoring include:

- 2G, 3G, 4G high-speed telephone networks, with large coverage, but not yet covered in remote areas, especially in areas without electricity
- 2.4GHz band radio network including ZigBee, Bluetooth, Wifi with high speed, but narrow range
- LPWAN low energy wide area network has high coverage, low speed, low energy.

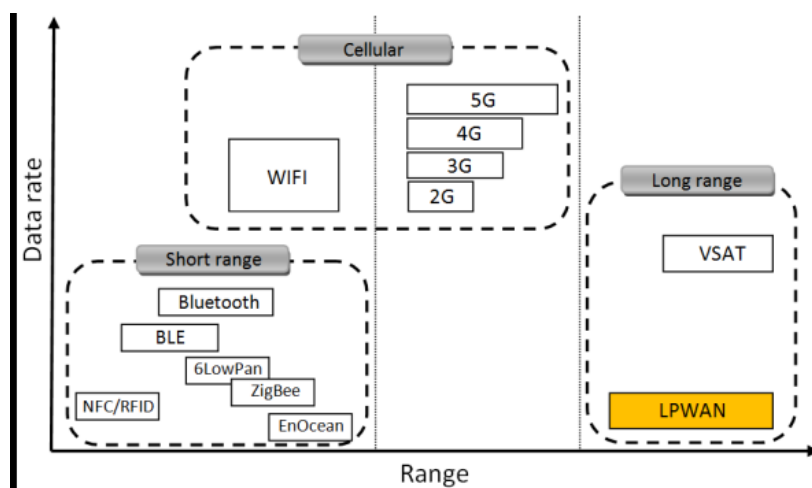

Figure1. The amount of data and the distance of wireless communications technologies

LPWAN is gaining increasing attention in both industry and research because of its low power, long distance and low cost. It can travel up to 10-40km in rural areas, 1-5km in urban areas [1]. It is also energy-efficient (10 years battery-operated [2]) and is inexpensive, with the cost of signal modulation ICs being around \$ 3 [3]. These strengths of LPWAN lead to many studies on the possibility of LPWAN in indoor and outdoor environments. These studies indicate that LPWAN is well suited for IoT applications that communicate long distances with small amounts of data (Figure1).

By the year 2013, the term LPWAN hasn't existed yet. There have been many LPWAN technologies being developed, both on the licensed and license-free band. The most popular among them are Sigfox, LoRa and NB-IoT.

Sigfox was developed in 2010 by the Sigfox start-up (in Toulouse, France), both as a developer and as an operator of the LPWAN network. Sigfox operates and commercializes their IoT solution at 31 countries and is expanding globally.

LoRa was developed by start-up Cycleo in 2009 (in Grenoble, France) and three years later was acquired by Semtech (USA). In 2015, LoRa was standardized by the LoRa Association (LoRa-Alliance) and was deployed in 42 countries and is still expanding worldwide.

NB-IoT is LPWAN technology based on narrowband radio technology and standardized by 3GPP (3rd generation partnership project). The specification was released in 2016. NB-IoT is still testing in Europe. In 2016, Vodafone and Huawei integrated NB-IoT into the Spanish Vodafone network and sent the first data from a water sensor. Currently, Huawei is expanding cooperation to deploy this technology worldwide. In May 2017, China's Ministry of Industry and Information Technology announced it would increase its use of NB-IoT for smart cities and services.

Technical differences, features, coverage, range, latency, battery life, etc. were compared in [4], as shown in Table1.

Table1. Comparison of three LPWAN technologies: Sigfox, LoRa và NB-IoT [4]

	Sigfox	LoRa	NB-IoT
Modulation	BPSK	CSS	QPSK
Frequency	License-free	License-free	Licensed LTE
Bandwidth	100Hz	7,8kHz-500kHz	200kHz
Maximum speed	100bps	50kbps	200kbps
Bi-direction	Limited/Half-duplex	Yes/ Half-duplex	Yes/ Half-duplex
Messages/day	140 (up), 4 (down)	Unlimited	Unlimited
Maximum message size	12 bytes (up), 8 bytes (down)	243 bytes	1600 bytes
Range	10km (urban), 40km (rural)	5km (urban), 20km (rural)	1km (urban), 10km (rural)
Noise resistance	Very high	Very high	Low
Authentication and security	Not supported	Yes (AES 128b)	Yes (LTE)
Adaptive speed	No	Yes	No
Allow private network	No	Yes	No
Standardization	Sigfox and ETSI	LoRa Association	3GPP

Based on the requirements of the problem set out in the paper, LoRa was selected for the following characteristics:

- Operating in license-free band
- Asynchronous transmission protocol
- CSS modulation (Chirp spread spectrum) helps signal with low noise, anti-interference, difficult to detect and block signals
- Long battery life
- Allows a large number of terminals (up to 50,000)
- The data frame of 243 bytes is sufficient for the application of the topic
- Average range (<20km, not as far as Sigfox, but larger than NB-IoT)
- Flexible deployment model that allows creating private network (Sigfox and NB-IoT do not allow)
- Low cost

III. Design Monitoring System

A. Monitoring system overview

Proposed remote monitoring and warning solution to support the management and safe use of electricity for independent electricity users are as follows:

- At each independent household power station (HPS), a monitoring device is installed to monitor the operation of the independent electricity supply system and transmit information to the center.
- Each district has a central monitoring station (CMS) in the center of the district (or other convenient location), to collect data from HPS, helping to monitor the operation and detect incidents.

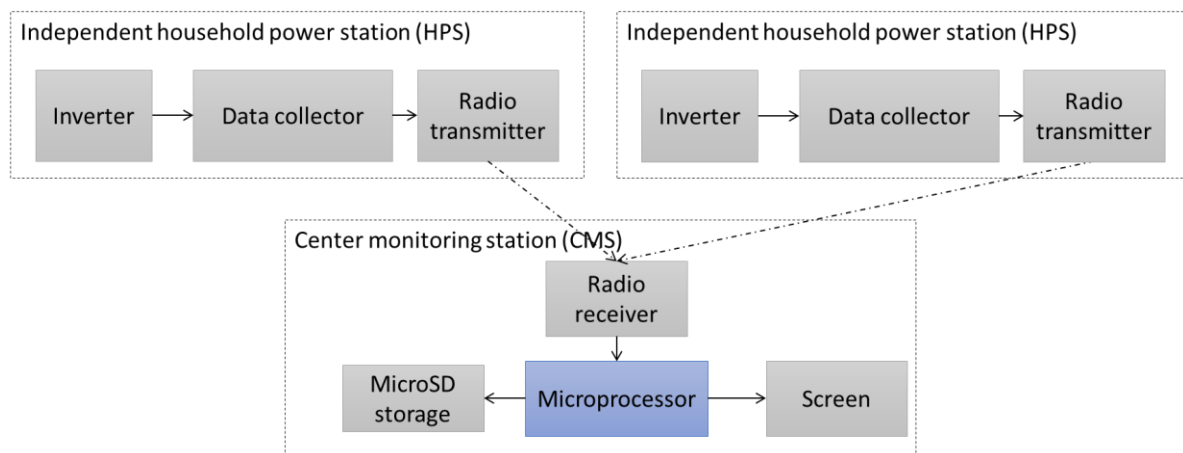

Figure1. System diagram

HPS household monitoring equipment: To monitor the operation of the living electricity supply system, HPS reads information from the inverter and meters (if any) via Modbus protocol on RS485 or RS232.

HPS has a transceiver for transmitting signals to CMS.

Central monitoring station (CMS):

CMS has a device to receive radio signals to receive signals from HPSs.

To support the safe use of electricity, CMS can display warning, instructions in Vietnamese or warning by light and sounds. This is necessary because the equipment for independent power station usually doesn't have Vietnamese interface.

To serve the purpose of management, quality assessment in the future, CMS stores historical data to the memory card. Information on a memory card can be read and analyzed on a computer.

Table1. Functionalities of HPS and CMS

Functionalities	HPS	CMS
Read from inverter	Yes	No
Warning	Yes	Yes
Incident indicating	No	Yes
Display realtime measurements	Yes	Yes
Radio transceiver	Transmitting	Receiving
Historical data storage	No	Yes

B. LoRa CHARACTERISTICS

The LoRa signal transmission has the following important parameters:

- Bandwidth (BW): the width of carrier frequency. Increasing bandwidth allows higher data rates, but is more sensitive to noise. Bandwidth reduction requires more accurate quartz and lower data rates. LoRa supports bandwidth from 7.8 kHz to 500 kHz.
 - Code rate (CR): is the number of bits added in the LoRa packet payload so that the receiving circuit can be used to recover some of incorrectly received bits and thereby to recover payload data. CR is an integer value from 1 to 4 and are usually expressed as $4 / CR + 4$ (e.g. 4/5, 4/6, 4/7, 4/8). Therefore, the higher the CR usage, the greater the ability to receive correct data, but in return the LoRa chip will have to send more data and increase the transmission time.
 - Spreading factor (SF): is the duration of the chirp. A character encoded into 2^{SF} blink. Higher SF improves signal-to-noise ratio, which increases the sensitivity and long range, but increases packet air time and power consumption. SF is an integer value between 7 and 12.
 - Transmission power: Output power is in mW and can be converted into dB according to the formula: $P_{dB} = 10\lg(P_{mW})$, where P_{mW} is the transmitted power measured in mW. On the market, LoRa modules come with variants of 10-30dB, equivalent to 10mW to 1000mW.
 - Carrier frequency (fc): Frequency to modulate the input signal. LoRa is popular with frequencies of 315MHz, 433MHz, 866MHz, 915MHz and recently Semtech has added LoRa IC that modulates signal at 2.4GHz.
- The bit rate of the LoRa modulation is calculated by the following formula (bps)[5]:

$$R_b = SF * \frac{BW}{2^{SF}} * \frac{4}{4 + CR}$$

Where, SF - spreading factor (7 ~ 12), BW - bandwidth (Hz), CR - code rate (1 ~ 4).

Some typical bit rates corresponding to SF, BW and CR configurations are shown in Table2.

Table2. Typical bit rate of LoRa

SF	BW (kHz)	CR	Rb (bps)	SF	BW (kHz)	CR	Rb (bps)	SF	BW (kHz)	CR	Rb (bps)
12	7.8	1	18	11	125	1	537	8	125	1	3125
12	10.4	1	24	11	250	1	1074	8	250	1	6250
12	15.6	1	37	11	500	1	2148	8	500	1	12500
12	20.8	1	49	10	125	1	977	7	125	1	5469
12	31.2	1	73	10	250	1	1953	7	250	1	10938
12	41.7	1	98	10	500	1	3906	7	500	1	21875
12	62.5	1	146	9	125	1	1758				
12	125	1	293	9	250	1	3516				
12	250	1	586	9	500	1	7031				
12	500	1	1172								

The signal sent from the transmitter to the receiver is lost on the free-space path loss (FSPL) with the formula [6]:

$$FSPL = 20 \lg(d) + 20 \lg(f) + 32,45$$

In which, d - distance (km), f - frequency (MHz). FSPL is measured in dB. From the above formula shows that the higher the carrier frequency, the greater the loss in the transmission line.

The level of signal loss is shown in the

Table3.

Table3. LoRa Free-space path loss

Freq 433 MHz		Freq 315 MHz		Freq 868 MHz		Freq 915 MHz	
d (km)	FSPL	d (km)	FSPL	d (km)	FSPL	d (km)	FSPL
0.001	25.2	0.001	22.4	0.001	31.2	0.001	31.7
0.01	45.2	0.01	42.4	0.01	51.2	0.01	51.7
0.1	65.2	0.1	62.4	0.1	71.2	0.1	71.7
0.2	71.2	0.2	68.4	0.2	77.2	0.2	77.7
0.5	79.2	0.5	76.4	0.5	85.2	0.5	85.7
1	85.2	1	82.4	1	91.2	1	91.7

2	91.2	2	88.4	2	97.2	2	97.7
5	99.2	5	96.4	5	105.2	5	105.7
10	105.2	10	102.4	10	111.2	10	111.7

To be able to build applications with LoRa, currently on the market there are many LoRa modules. The most popular LoRa modulation IC are LoRa SX1276/77/78/79/80 made by Semtech. SX1278 is the most popular with modules using 433 MHz band, while SX1276 is often used for modules support 868/915 MHz band. The newly launched SX1280 uses the same 2.4GHz band as WiFi and Bluetooth, which may be a suitable option in the future. These chips support communication in SPI standard with microcontroller. Using SPI communication, LoRa's parameters mentioned above such as BW, SF, CR, etc can be configured. Some SPI communication modules can be named: Heltec WiFi LoRa 32, Dragino LoRa Shield, RFM95 / 96/97 / 98W.

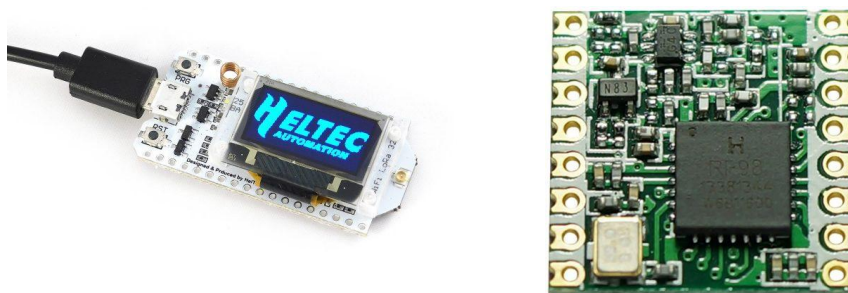

Hình 2. Module Heltec WiFi LoRa 32 và RFM98W
Module Heltec WiFi LoRa 32 và RFM98W

There are also modules that support UART standard communication. Inside the module has a built-in microcontroller (such as STM8, STM32, ...) and a LoRa chip, these modules often don't allow to configure the LoRa parameters such as BW, SF, CR. Host microcontroller can only set address, air rate, UART rate, ... The most popular modules of this type are the E32 LoRa series made by Ebyte such as: E32-TTL-100 (433T20DC), E32-TTL-1W (433T30D), ...

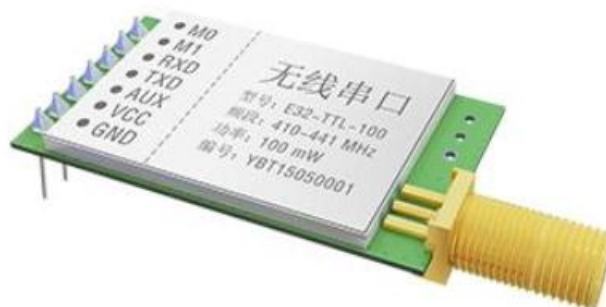

Hình 3. Module LoRa E32-TTL-100
Module LoRa E32-TTL-100

The simple, easy-to-use LoRa E32-TTL-100 module makes device development easy, but is incompatible with the LoRaWAN standard [7] in general because the data is encoded in an undisclosed standard, i.e. only E32-TTL-100 modules can communicate with each other. However, with the scope of the paper, for the purpose of testing equipment, testing the operating principles of the system, this module fully meets the requirements.

Tested with E32-TTL-100, when this module operates with default parameters (bit rate of 2400bps) it is corresponding to parameters LoRa as following: BW = 500kHz, SF = 11, CR = 1. In Figure III.6 is an analysis of the LoRa signal spectrum from the E32-TTL-100 module.

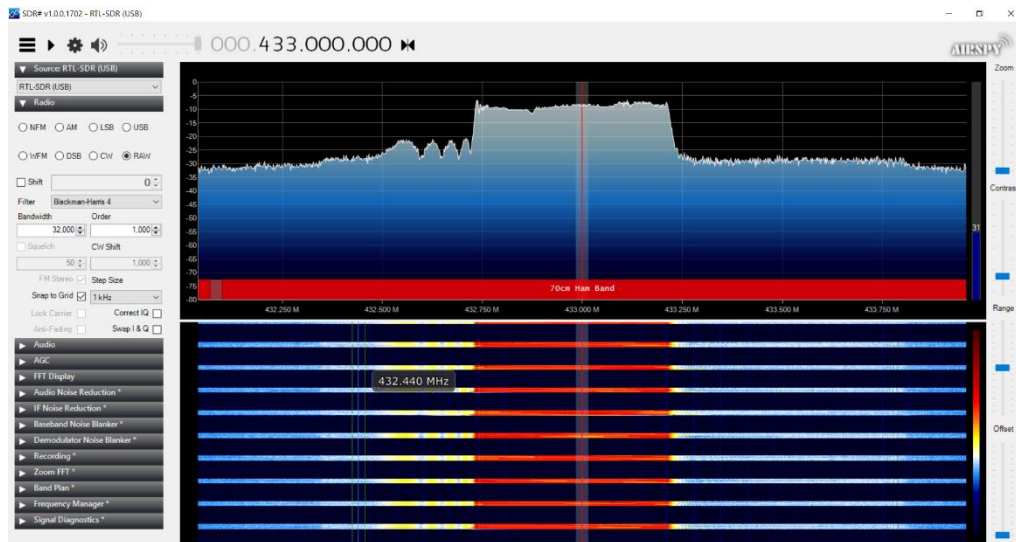
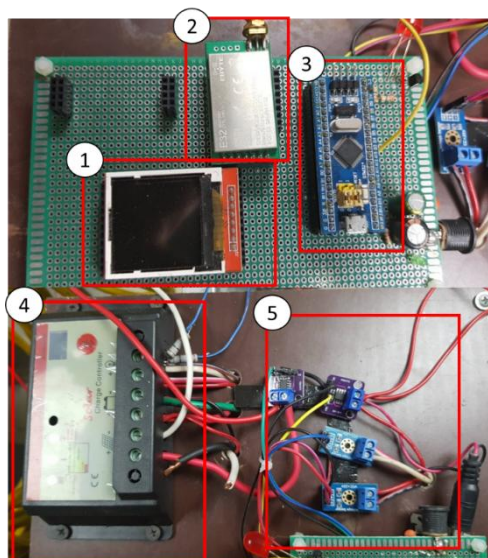

Figure4. Spectrum analysis of LoRa signal transmitted from E32-TTL-100 module with default parameters (2400bps)

IV. System Equipment Testing

Experimental models for the above solution were built, including:

- Independent power station model and monitoring equipment
- Central monitoring station equipment model to collect data and displays operating information of an independent power station



1-Display monitor; 2-LoRa Module; 3-Microcontroller STM32F103C8T6; 4-Solar charger DC/DC; 5-Voltage and current sensors

Figure1. Independent power station monitoring equipment

Microcontroller (3) reads current and voltage values measured by voltage and current sensors (5) in and out of solar battery charger (4), displays it on screen (1) and transmits data back to center monitoring station through LoRa module (2).

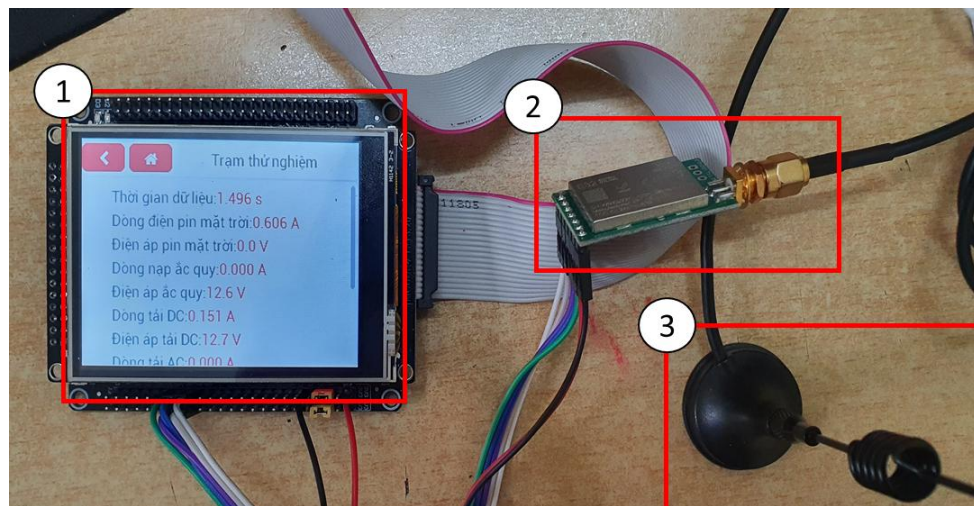

1-Development kit with microcontroller STM32F407 and display (integrated mini-SD socket); 2-LoRa module; 3-LoRa Antenna.

Figure2. Center monitoring station equipment

The microcontroller reads information sent from the independent power stations via the LoRa E32-TTL-100 module and displays it on the screen. The collected data is also written to the memory card. The center monitoring station hardware has evolved in two versions. The first version uses a smaller screen and a lower speed microcontroller. The second version uses a larger screen, higher speed microcontroller. The microcontrollers used in HPS and CMS are both the STM32 family, thus they use the same programming tools and libraries.

The embedded software for HPSs does the following functions:

- Read current sensor data and voltage through the ADC
- Display measurement data on ILI9341 type screen
- Communicate with LoRa E32-TTL-100 module to configure LoRa
-

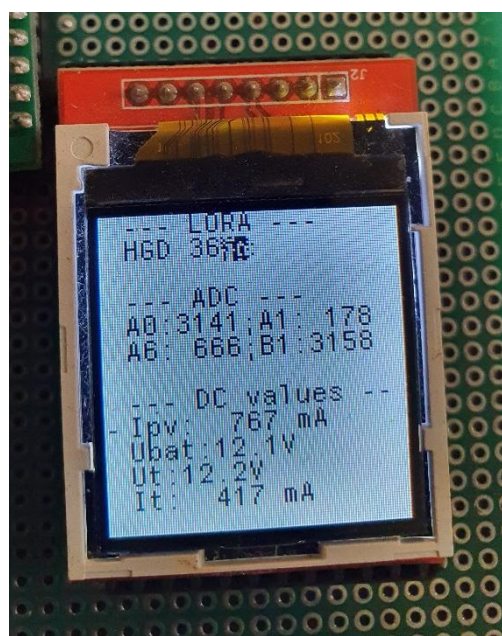

Figure3. Screen shows the operation variables of the system (I_{pv}: current from solar panel, U_{bat}: voltage of battery, U_t: load voltage, I_t: load current)

The embedded software for CMSs does the following functions:

- Read data sent from HPSs via the LoRa E32-TTL-100 module
- Interface to select HPS for its detail information
- Display each HPS realtime data

– Save the received historical data to a memory card for storage

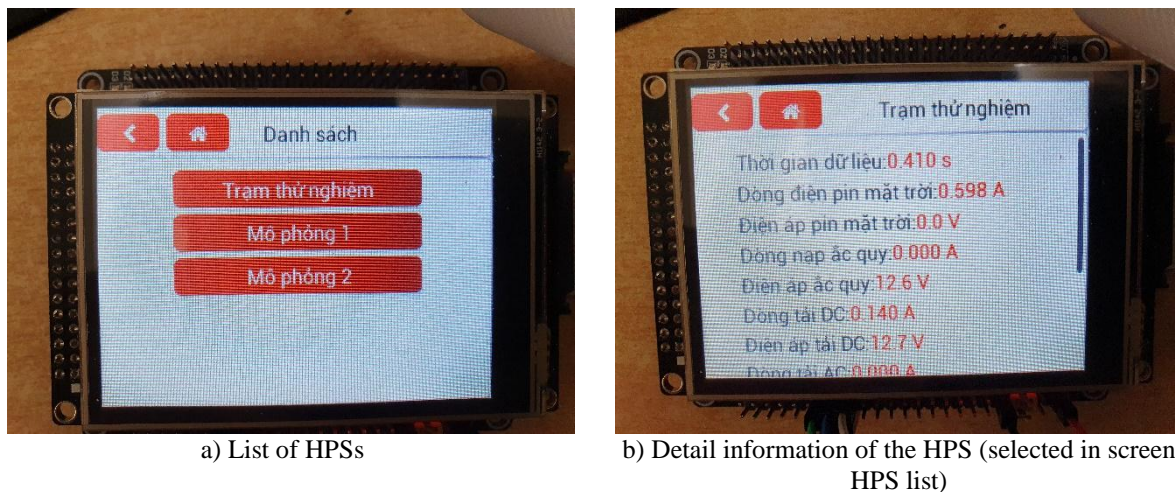

Figure4. Screens of CMSs

The complete HPS model's equipment is shown in Figure5. The operating parameters of HPS are shown on the screen in Figure3. In Figure4 is the interface of center monitoring station, showing the HPS list (Figure4a) and details of each station (Figure4b).



Figure5. Completed HPS model: solar panel, DC/DC solar charger, batteries and monitoring equipment

The tests of the operating range of the device are conducted at 2 locations:

– At Vietnam Academy of Science and Technology (VAST) (Figure6):

- HPS model is located at the campof Institute of Energy Science, Vietnam Academy of Science and Technology (VAST).
- Center monitoring station is supplied from a portable battery, and are being moved within the premises of the Vietnam Academy of Science and Technology and to outside streets.

– On Nhat Tan bridge (Figure7)

- The transmitter of HPS placed on the Nhat Tan bridge.
- Center monitoring station is supplied from a portable battery, and are being moved along the street nearby.

On Figure6 shows 1st test location among dense buildings in VAST and nearby streets. On Figure7 shows 2nd test location on the Nhat Tan bridge. On Table4 shows the test results.



Figure6. Operation range testing in dense buildings in VAST and nearby streets



Figure7. Operation range testing in open area near Nhat Tan bridge

Table4. Packet loss rate in the test

Point	Distance	Total packets	Dropped packets	Loss rate
At Vietnam Academy of Science and Technology				
1	308m	1500	367	24,5%
2	435m	1500	156	10,4%
On Nhat Tan bridge				
1	1570m	1500	12	0,8%
2	4350m	1500	17	1,1%

At the Vietnam Academy of Science and Technology, position 1 is closer but has a higher packet loss rate than position 2. At Nhat Tan Bridge, transmission medium is free space, the packet loss rate increases with the distance. It shows that the effect of obstacles on the transmission line is much greater than transmission distance.

V. Conclusion

The paper presented a solution to monitor independent household power stations in rural areas of Vietnam. For purpose of communication between household power station and center monitoring station, the most popular wireless communication technologies were analyzed and LoRa technology was chosen. A physical model of the system were developed. Range test also was conducted in two areas: at Vietnam Academy of Science and Technology, in which building density is dense, and on Nhat Tan bridge, where the transmission medium is free open space.

The system works as expected. Monitoring data is gathered and transmitted to center monitoring station, where the data is shown on the screen correctly. In dense buildings area, the communication range is somewhat limited due to obstacles of the buildings. At free open space, the communication range reaches 3-4km.

LoRa (Long Range) is a new wireless standard in recent years, specially designed for low-power wide area network (LPWAN) applications, to connect devices with low speed, but wide coverage and low power consumption. The research results of the project will be the premise to apply not only to energy monitoring but also to other fields.

References

- [1]. M. Centenaro, L. Vangelista, A. Zanella, M. Zorzi, , "Longrange communications in unlicensed bands: The rising stars in the IoT and smart city scenarios," IEEE J. Wir. Commun, vol. 23, n° 5, pp. 60-67, 2016.
- [2]. D. Patel, M. Won, "Experimental Study on Low Power Wide Area Networks for Mobile Internet of Things," em Proc. of VTC, Sydney, Australia, 2017.
- [3]. U. Raza, P. Kulkarni, M. Sooriyabandara,, "Low Power Wide Area Networks: An Overview," IEEE J. Commun. Surv. Tuto. , vol. 19, n° 2, pp. 855-873, 2017.
- [4]. Mekki, K., Bajic, E., Chaxel, F., & Meyer, F. (2018)., "A comparative study of LPWAN technologies for large-scale IoT deployment..," ICT Express, 2017.
- [5]. Semtech, "AN1200.22, LoRa modulation basics," Semtech, 2015.
- [6]. Michael Rademacher, Karl Jonas, Osianoh Glenn Aliu, "Path Loss Models for Low-Power Wide-Area Networks: Experimental Results using LoRa," em VDE ITG-Fachbericht Mobilkommunikation, May, 2018.
- [7]. EByte, "E32-433T20DC User Manual SX1278 433MHz 100mW DIP Wireless Module," Chengdu Ebyte Electronic Technology Co.,Ltd, 2019.

NGO Phuong Le. " Remote Monitoring System For Independent Power Stations In Rural And Mountainous Areas In Vietnam." *IOSR Journal of Electronics and Communication Engineering (IOSR-JECE)* 15(3), (2020): 18-27.