

# Kinematics And Workspace Analysis Of The Delta Robot

Laining,Zheng<sup>1</sup>, Yongpeng,Chen<sup>2</sup>

<sup>1,2</sup>(School of Agricultural Engineering and Food Science,Shandong University of Technology, Zibo ,China)

## Abstract:

This article mainly introduces the structure and degree of freedom analysis of Delta parallel robot. Using space geometry and vector algebra methods to establish a simplified kinematics model of a parallel robot .Use geometric solution method to perform forward kinematic solution, the inverse solution is relatively simple, which is to calculate the joint angle based on the position of the end platform. Finally, the workspace is simulated and analyzed through Matlab software to verify that the parallel robot meets the needs of actual engineering applications.

**Key Word:** Delta parallel robot; Kinematics analysis; Workspace; Matlab.

Date of Submission: 18-10-2023

Date of Acceptance: 28-10-2023

## I. Introduction

The Delta parallel robot was invented by Dr. R. Clavel in 1985. It is the most commonly used type of parallel robot today<sup>[1,2]</sup>. As people's understanding of the nature of robots deepens, parallel mechanisms that meet the definition of robots are called parallel robots. It means that the moving platform and the static platform are connected through at least two independent branch chains and have two or more degrees of freedom. , a closed-loop mechanism driven in parallel<sup>[3,4,5,6]</sup>.

Compared with series mechanisms, parallel robots have greater stiffness, compact and stable structure, large load-bearing capacity, fast movement speed, and high positioning accuracy. Therefore, their applications are becoming more and more widespread, and their development and research are becoming more and more in-depth<sup>[7,8,9,10,11]</sup>.

## II. Delta Robot Kinematics Analysis

### Structural composition of Delta robot

The Delta robot is composed of basic components such as a moving platform, a static platform, an active arm, a driven arm, and a drive motor<sup>[12,13]</sup>, as shown in Fig.1.

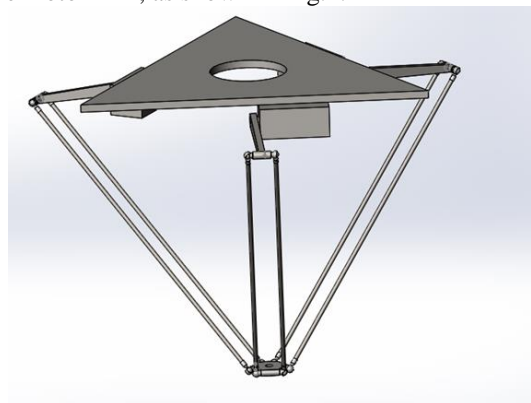

Figure 1. Delta robot structure model

### Analysis of the robot's degrees of freedom

The degree of freedom of a parallel mechanism refers to the minimum number of independent degrees of freedom required for the relative movement of the end effector under the conditions of meeting the working requirements. The degree of freedom of a mechanism is an important indicator of its movement performance<sup>[14]</sup>. The degrees of freedom of a parallel robot can be obtained by the famous Kutzbach-Grubler formula.Eq.1.

$$F = d(n - g - 1) + \sum_{i=1}^g f_i \quad (1)$$

In Eq.1,  $F$  is the total number of degrees of freedom;  $n$  is the total number of components;  $g$  is the total number of kinematic pairs,  $f_i$  is the number of degrees of freedom of the  $i$ -th kinematic pair;  $d$  is the mechanism order,  $d=6$  for space mechanisms, and  $d=3$  for planar mechanisms. The Delta robot has a static platform, a moving platform, three active arms and three driven arms. The total number of components is  $n=8$ ; the mechanism has 3 rotating pairs and 6 Hooke hinges, and the total number of kinematic pairs is  $g=9$ . Each rotating pair has only one degree of freedom, and each Hooke joint has two degrees of freedom<sup>[15,16]</sup>. Substituting the above parameters into Eq.1.

$$F = d(n - g - 1) + \sum_{i=1}^g f_i = 6 \times (8 - 9 - 1) + 3 + 6 \times 2 = 3$$

Therefore, the Delta robot studied in this article is a three-degree-of-freedom parallel robot.

**Forward kinematics solution**

Given the rotation angles of the three active arms of the parallel robot, finding the position of the center point of the moving platform is called the forward kinematics solution. For the forward solution of parallel robot kinematics, the commonly used solution is to use a numerical solution method based on algebraic equations. The advantage is that the mathematical model is simple and convenient for programming and calculation, but the disadvantage is that the calculation amount is large and the solution speed is slow, during the solution process, it is necessary to make trade-offs between multiple solutions, and appropriate initial values must be given during calculation, otherwise it will easily cause the iteration to fail to converge. The geometric analysis method used in this article can obtain the correct solutions to the positive solutions of all positions, avoiding the problem of choosing between multiple solutions. When solving the three-degree-of-freedom parallel robot, the derivation process is simple and clear<sup>[17]</sup>.

Schematic diagram of the simplified model of the Delta robot, as shown in Fig.2. The slave arm  $B_iC_i$  ( $i=1,2,3$ ) is translated along the vector  $\overline{B_iP}$  ( $i=1,2,3$ ) respectively. After translation, we obtain  $D_iP$ , three vectors intersect at point  $P$ . The triangle  $\triangle A_1A_2A_3$  formed by the static platform is an equilateral triangle, and the radius of the circumscribed circle is known, the coordinates of point  $A$  in the coordinate system  $\{O\}$  can be obtained. When the rod lengths and rotation angles of the three input rods are given, the coordinates of  $B$  in the base coordinate system  $\{O\}$  can be obtained, and the translation vector  $C_iP$  can be obtained, then the coordinates of  $D_i$  after  $B_i$  is translated can be obtained. In this way, the forward kinematics problem of the parallel robot mechanism is ultimately equivalent to the problem of obtaining the vertex coordinate  $P$  of the triangular vertebra  $P-D_1D_2D_3$ . Under the condition that all side lengths and three vertex coordinates of the triangular vertebra are known, it is easy to obtain The coordinates of vertex  $P$  in the base coordinate system  $\{O\}$ .

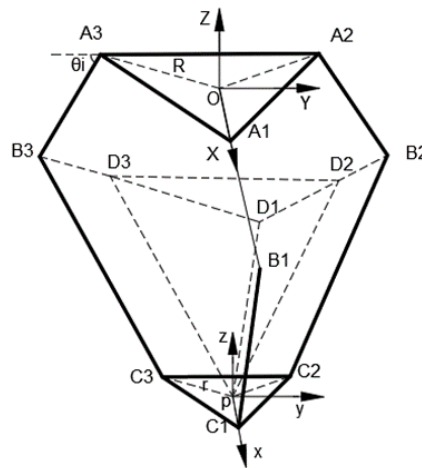

Figure 2. Delta robot simplified model diagram

The hinge point  $A_i$  ( $i=1,2,3$ ) of the static platform is  $120^\circ$  circumferentially symmetrical, so the coordinates of the hinge point can be expressed as:

$$\begin{bmatrix} x_{A_i} \\ y_{A_i} \\ z_{A_i} \end{bmatrix} = \begin{bmatrix} R \cos \omega_i \\ R \sin \omega_i \\ 0 \end{bmatrix} \tag{2}$$

In Eq.2,  $\omega_i$  is the angle between  $OA_i$  ( $i=1,2,3$ ) and the X-axis of the coordinate axis,  $\omega_i = \frac{2\pi}{3}(i-1)$  ( $i=1,2,3$ ); R is the radius of the circumscribed circle of the hinge point of the static platform.

Vector  $\overrightarrow{A_iB_i}$  ( $i=1,2,3$ ) can be expressed as:

$$\overrightarrow{A_iB_i} = \begin{bmatrix} L \cos \theta_i \cos \omega_i \\ L \cos \theta_i \sin \omega_i \\ -L \sin \theta_i \end{bmatrix} \quad (3)$$

In Eq.3, L is the length of the active arm;  $\theta_i$  is the rotation angle of the active arm, both of which are known quantities.

Then the coordinate vector of the active arm end point  $B_i$  ( $i=1,2,3$ ) can be expressed as:

$$\overrightarrow{OB_i} = \overrightarrow{OA_i} + \overrightarrow{A_iB_i} = \begin{bmatrix} (R + L \cos \theta_i) \cos \omega_i \\ (R + L \cos \theta_i) \sin \omega_i \\ -L \sin \theta_i \end{bmatrix} \quad (4)$$

The translation vector  $\overrightarrow{C_iP}$  ( $i=1,2,3$ ) can be expressed as:

$$\overrightarrow{C_iP} = \begin{bmatrix} -r \cos \omega_i \\ -r \sin \omega_i \\ 0 \end{bmatrix} \quad (5)$$

In Eq.5, r is the radius of the circumscribed circle of the hinge point of the moving platform.

It can be concluded that the coordinates of the vertex  $D_i$  ( $i=1,2,3$ ) of the base triangle of the triangular pyramid P- $D_1D_2D_3$  in the base coordinate system {O} can be expressed as:

$$\overrightarrow{OD_i} = \overrightarrow{OB_i} + \overrightarrow{B_iD_i} = \overrightarrow{OB_i} + \overrightarrow{C_iP} = \begin{bmatrix} (R - r + L \cos \theta_i) \cos \omega_i \\ (R - r + L \cos \theta_i) \sin \omega_i \\ -L \sin \theta_i \end{bmatrix} \quad (6)$$

Therefore, the problem of solving the forward kinematics of the parallel robot becomes a problem of finding the coordinates of the fourth vertex P, given the three vertex coordinates and edge lengths of the triangular pyramid. The idea of solving the problem is to first find the vertical feet of the triangular pyramid vertex P and the bottom triangle, and then find the vertical vector, thereby finding the coordinates of the vertex P.

In this triangular pyramid, Fig.3. it is known that point E is the center of the circumcircle of triangle  $\Delta D_1D_2D_3$ , and point F is the midpoint of  $D_1D_2$ . Because both  $\Delta PD_1D_2$  and  $\Delta ED_1D_2$  are isosceles triangles, and point F is the midpoint of  $D_1D_2$ , we can get  $PF \perp D_1D_2$ ,  $EF \perp D_1D_2$ . According to the three perpendicular theorem of solid geometry, we can get  $D_1D_2 \perp \Delta PEF$ , so we can get  $PE \perp D_1D_2$ . In the same way, we can prove  $PE \perp D_2D_3$ . Therefore,  $PE \perp \Delta D_1D_2D_3$ , we get that PE is the perpendicular to triangle  $\Delta D_1D_2D_3$ .

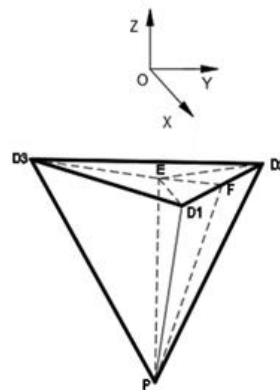

Figure 3. Delta robot equivalent kinematics model

The coordinate vector of vertex P in the base coordinate system {O} can be expressed as:

$$\overrightarrow{OP} = \overrightarrow{OE} + \overrightarrow{EP} = \overrightarrow{OF} + \overrightarrow{FE} + \overrightarrow{EP} \quad (7)$$

In Ep.7, since point F is the midpoint of side  $D_1D_2$ , so the vector  $\overrightarrow{OF}$  can be expressed as:

$$\overrightarrow{OF} = (\overrightarrow{OD_1} + \overrightarrow{OD_2})/2 \quad (8)$$

The vector  $\overrightarrow{FE}$  can be expressed as:

$$\overrightarrow{FE} = |\overrightarrow{FE}| \times \overrightarrow{e_{FE}} \quad (9)$$

Express the modulus  $|\overrightarrow{FE}|$  of the vector  $\overrightarrow{FE}$  as:

$$|\overrightarrow{FE}| = \sqrt{|\overrightarrow{D_1E}|^2 - |\overrightarrow{D_1F}|^2} \quad (10)$$

The radius  $|\overrightarrow{D_1E}|$  of the circumcircle of triangle  $\Delta D_1D_2D_3$  is expressed as:

$$\begin{cases} |\overrightarrow{D_1E}| = |\overrightarrow{D_1D_2}| \cdot |\overrightarrow{D_2D_3}| \cdot \frac{|\overrightarrow{D_1D_3}|}{4S} \\ S = \sqrt{p(p - |\overrightarrow{D_1D_2}|)(p - |\overrightarrow{D_1D_3}|)(p - |\overrightarrow{D_2D_3}|)} \\ p = \frac{(|\overrightarrow{D_1D_2}| + |\overrightarrow{D_1D_3}| + |\overrightarrow{D_2D_3}|)}{2} \end{cases} \quad (11)$$

The unit vector  $\overrightarrow{e_{FE}}$  is expressed as:

$$\overrightarrow{e_{FE}} = \frac{\overrightarrow{D_1D_2} \times \overrightarrow{D_2D_3} \times \overrightarrow{D_1D_3}}{|\overrightarrow{D_1D_2} \times \overrightarrow{D_2D_3} \times \overrightarrow{D_1D_3}|} \quad (12)$$

The vertical vector  $\overrightarrow{EP}$  can be expressed as:

$$\overrightarrow{EP} = |\overrightarrow{EP}| \cdot \overrightarrow{e_{EP}} \quad (13)$$

The module of vector (EP) can be expressed as:

$$|\overrightarrow{EP}| = \sqrt{|\overrightarrow{D_1P}|^2 - |\overrightarrow{D_1E}|^2} \quad (14)$$

The unit vector  $\overrightarrow{e_{EP}}$  can be expressed as:

$$\overrightarrow{e_{EP}} = \frac{\overrightarrow{D_1D_2} \times \overrightarrow{D_2D_3}}{|\overrightarrow{D_1D_2} \times \overrightarrow{D_2D_3}|} \quad (15)$$

After the above calculation and derivation, the forward solution to the kinematics of the parallel robot is obtained. According to the rotation angle  $\theta_i$  ( $i=1, 2, 3$ ) between the active arm and the static platform, the position of the center of the moving platform can be obtained.

### Inverse kinematics solution

When the position of the center point of the parallel robot's moving platform is known, solving the rotation angles of the three active arms is called the inverse kinematics solution. Assuming that the rotation angles of the three drive joints of the Delta robot are  $\theta_i$  ( $i=1,2,3$ ), according to the forward kinematics formula of the robot, the coordinates of the active arm end point  $B_i$  ( $i=1,2,3$ ) in the base coordinate system  $\{O\}$  can be obtained, the coordinates of the driven arm end point  $C_i$  ( $i=1,2,3$ ) in the coordinate system  $\{P\}$  can also be obtained. Since the position of the center point  $P$  of the moving platform is a known quantity, the coordinates of point  $C_i$  ( $i=1,2,3$ ) in the base coordinate system  $\{O\}$  can be obtained. Taking the length  $L_{BC}$  of the driven rod as a constraint, the rotation angle  $\theta_i$  ( $i=1,2,3$ ) of the driving joint can be obtained through the equations<sup>[18,19,20]</sup>.

The coordinates of the active arm end point  $B_i$  in the base coordinate system  $\{O\}$  can be expressed as:

$$\begin{bmatrix} x_{Bi} \\ y_{Bi} \\ z_{Bi} \end{bmatrix} = \begin{bmatrix} (R + L_{AB} \cos \theta_i) \cos \omega_i \\ (R + L_{AB} \cos \theta_i) \sin \omega_i \\ -L_{AB} \sin \theta_i \end{bmatrix} \quad (16)$$

The coordinates of the driven arm end point  $C_i$  in the coordinate system  $\{P\}$  are expressed as:

$$\begin{bmatrix} P_{x_{Ci}} \\ P_{y_{Ci}} \\ P_{z_{Ci}} \end{bmatrix} = \begin{bmatrix} r \cos \omega_i \\ r \sin \omega_i \\ 0 \end{bmatrix} \quad (17)$$

The coordinate of the center point  $P$  of the moving platform in the base coordinate system  $\{O\}$  is  $[x \ y \ z]^T$ , then the coordinate of point  $C_i$  in the base coordinate system  $\{O\}$  can be expressed as:

$$\begin{bmatrix} x_{Ci} \\ y_{Ci} \\ P_{z_{Ci}} \end{bmatrix} = \begin{bmatrix} x + r \cos \omega_i \\ y + r \sin \omega_i \\ z \end{bmatrix} \quad (18)$$

Because  $|\overrightarrow{B_iC_i}| = L_{BC}$ , so we have Eq.19.

$$[(R - r + L_{AB}\cos\theta_i)\cos\omega_i - x]^2 + [(R - r + L_{AB}\cos\theta_i)\sin\omega_i - y]^2 + (L_{AB}\sin\theta_i + z)^2 = L_{BC}^2 \quad (19)$$

Let,  $\tan \frac{\theta_i}{2} = t$ , equation 19 can be simplified to equation 20

$$A_i t^2 + B_i t + C_i = 0 \quad (20)$$

$$A_i = (R - r)^2 + x^2 + y^2 + z^2 + L_{AB}^2 - L_{BC}^2 + 2(L_{AB} - R + r)(x\cos\alpha_i + y\sin\alpha_i) - 2(R - r)L_{AB};$$

$$B_i = 4zL_{AB};$$

$$C_i = (R - r)^2 + x^2 + y^2 + z^2 + L_{AB}^2 - L_{BC}^2 + 2(r - L_{AB} - R)(x\cos\omega_i + y\sin\omega_i) + 2(R - r)L_{AB};$$

Equation 20 is a quadratic equation about  $t_i$ . Solving for  $t_i$ , we can get equation 21,

$$t_i = \frac{-B_i \pm \sqrt{B_i^2 - 4A_i C_i}}{2A_i} \quad (21)$$

Therefore, when the coordinates of the center of the robot's moving platform are given, the rotation angle  $\theta_i$  ( $i=1,2,3$ ), can be obtained according to Eq.21. we can get equation 22.

$$\theta_i = 2\arctan t_i \quad (22)$$

According to the calculation results of the inverse kinematics of the robot, there are two sets of solutions for the rotation angle corresponding to each group of active arms, and the combination of the three groups of active arms will produce a total of eight sets of solutions. When the active arm is inside the static platform, that is, when the rotation angle  $\theta_i$  at the end point  $A_i$  is greater than  $90^\circ$ , interference will occur between the robot's rods, which will cause damage to the mechanism. Therefore, when inverse kinematics generates multiple solutions, a set of solutions with the active arms located outside the static platform should be selected, that is, the set of solutions with a smaller selection angle should be selected.

### III. Delta robot workspace analysis

The working space of the delta parallel robot is the set of all positions that the moving platform can reach. It is an important indicator to measure the working performance of the robot. Through the positive solution of kinematics, the corresponding relationship between the active arm rotation angle and the position of the moving platform can be obtained<sup>[21,22,23]</sup>.

Assume that the parallel robot under study will work on a conveyor belt with a width of 800mm. According to practical engineering experience, a set of robot structural parameters can be set first. After programming with Matlab software, a three-dimensional view of the robot's workspace can be drawn to check whether it conforms to the actual project.

**Table no 1 : Structural parameters of Delta robot.**

Name	symbol	Parameter value
Active arm length	La	360mm
Follower arm length	Lb	900mm
Radius of circumscribed circle of static platform	R	260mm
Radius of circumscribed circle of moving platform	r	50mm

#### Matlab simulation drawing results:

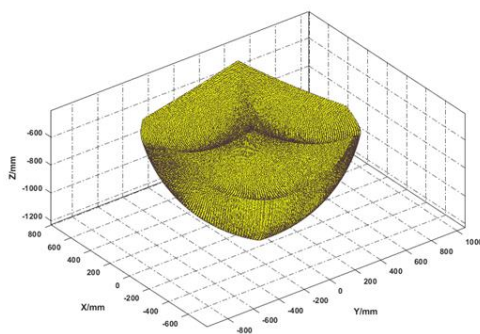

Figure 4. 3D view of the reachable workspace

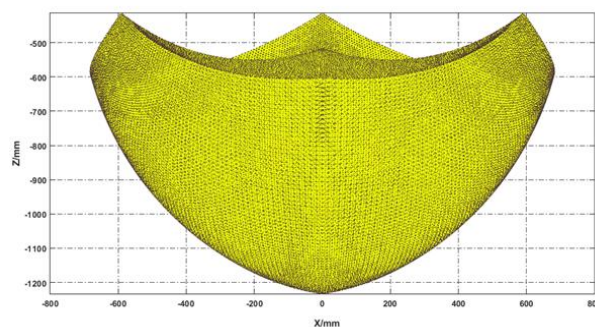

Figure 5. XOZ Plane projection diagram

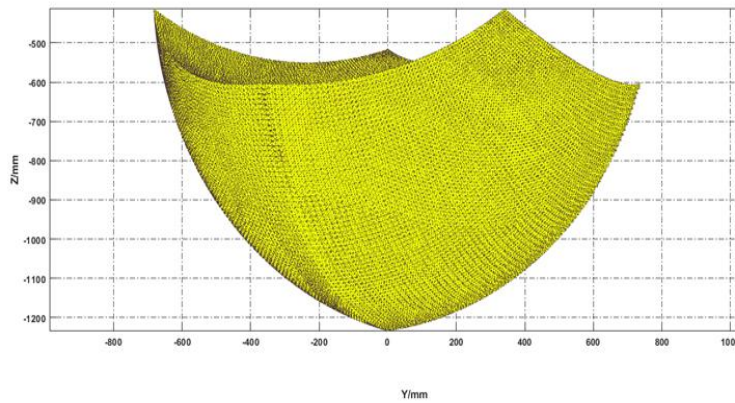
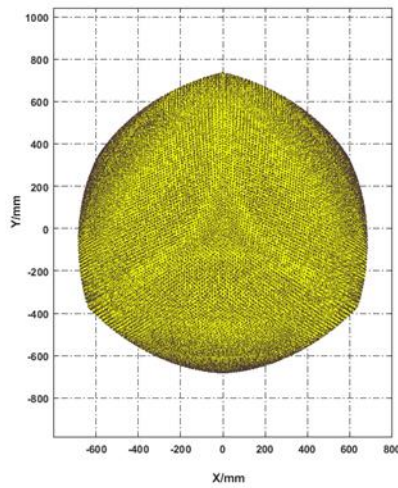

Figure 6. XOY Plane projection diagram

Figure 7. YOZ Plane projection diagram

From the generated outline of the workspace, Fig 5,6,7, it can be seen that the reachable range of the parallel robot in the X-axis direction is -680~680mm, the reachable range in the Y-axis direction is -680~680mm, and the reachable range in the Z-axis direction is -1230 ~ -410mm.

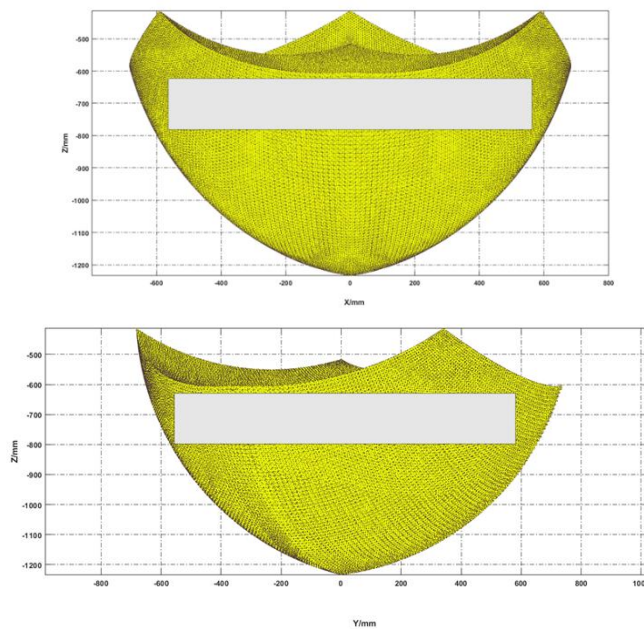

Figure 8. Schematic diagram of the effective workspace of the Delta robot

Under actual working conditions, the parallel robot mainly completes the grasping-translation-placement operation task. Its movement range is approximate to a cylinder. As shown in the figure 8, the effective working space ranges from -560 to 560mm in the X-axis and Y-axis range, and in the Z-axis range is -780~-620mm, which forms a cylinder with a diameter  $D=1120\text{mm}$  and a height  $h=260\text{mm}$ . This effective working space can meet the trajectory operation needs in actual engineering applications.

#### IV. Conclusion

Through the kinematics analysis of the robot in this article, we have obtained the methods for solving forward and inverse kinematics, and in subsequent research, we can use matlab programming to solve the results of the forward and inverse position solutions faster. Drawing a workspace diagram through matlab allows us to observe the effective workspace of the robot more intuitively and meet the design needs of the project. Position analysis is the prerequisite for studying robot workspace and trajectory planning, and also lays the foundation for subsequent speed and acceleration calculations of parallel robots[24].

#### References

- [1]. Clavel R. Dispositif pour le déplacement et le positionnement d'un élément dans l'espace[P]. 1987-6-18.
- [2]. Zhang Ketao, Fang Yuefa. Kinematics and workspace analysis of a new type of spatial three-degree-of-freedom parallel robot [J]. *Progress in Natural Science*, 2008(04):432-440.
- [3]. Feng Lihang, Zhang Weigong, Gong Zongyang, etc. Research progress and current situation of Delta series parallel robots [J]. *Robot*, 2014, 36(03): 375-384.
- [4]. Cai Zixing. *Fundamentals of Robotics* [M]. Beijing: Machinery Industry Press,2009.
- [5]. Merlet J P. *Parallel robots*[M]. Dordrecht, Netherlands:Springer Press, 2006.
- [6]. Chen X S, Chen Z L, Kong X M. Recent development and current status of Stewart platform research[J]. *Robot*, 2002, 24(5): 464-470.
- [7]. Clavel R. Device for displacing and positioning an element in space, Europe: EP0250470 B1[P]. 1991-07-17.
- [8]. Brogårdh T. Present and future robot control development—An industrial perspective[J]. *Annual Reviews in Control*, 2007, 31(1): 69-79.
- [9]. Poppeová V, Uriček J, Bulej V, et al. Delta Robots -Robots for high speed manipulation[J]. *Tehnicki vjesnik/Technical Gazette*, 2011, 18(3):435-445.
- [10]. Bouri M, Clavel R.The linear Delta: Developments and applications[C].The 41st International Symposium on Robotics. Frankfurt, Germany: VDE, 2010: 1198-1205.
- [11]. Milutinovic D, Slavkovic N, Kokotovic B, et al. Kinematic modeling of reconfigurable parallel robots based on Delta concept[J]. *Journal of Production Engineering*, 2012, 15(2): 71-74.
- [12]. Pierrot F, Nabat V, Company O, et al. Optimal design of a 4-DOF parallel manipulator: From academia to industry[J]. *IEEE Transactions on Robotics*, 2009, 25(2): 213-224
- [13]. Nabat V, de la Rodriguez M, Company O, et al. Par4: Very high speed parallel robot for pick-and-place[C].IEEE International Conference on Intelligent Robots and Systems. Piscataway, USA: IEEE, 2005: 553-558.
- [14]. Huang Zhen, Kong Lingfu, Fang Yuefa. *Parallel robot mechanism theory and control* Machinery Industry Press [M]. 1997.
- [15]. Liang Xiangning. *Delta robot kinematics modeling and simulation*[D]. Taiyuan University of Technology, 2008.
- [16]. Mao Hongguo. *Research on motion control of DELTA robot based on dynamic model*[D]. Harbin Institute of Technology, 2015.
- [17]. Zhao Jie, Zhu Yanhe, Cai Hegao. Geometric solution of forward kinematics of Delta type parallel robot [J]. *Journal of Harbin Institute of Technology*, 2003(01):25-27.
- [18]. Xu Guannan, Zhang Zhonghui, Xia Qingguan. Kinematic analysis of delta parallel robot [J]. *Mechanical Manufacturing and Automation*, 2015, 44(06): 160-162+192.
- [19]. Huang Chenhua. Geometric solution method for the inverse solution of kinematics of industrial robots [J]. *Manufacturing Automation*, 2014, 36(15):109-112.
- [20]. Zhao Yanjiang, Zhang Yongde, Jiang Jingang et al. Robot workspace solution method based on Matlab [J]. *Mechanical Science and Technology*, 2009, 28(12): 1657-1661+1666.
- [21]. Liu Shanzheng, Yu Yueqing, Jian Guoning, et al. Kinematics and dynamics analysis of 3-degree-of-freedom parallel robot [J]. *Transactions of the Chinese Society of Mechanical Engineering*, 2009, 45(08): 11-17.
- [22]. Li Baofeng, Sun Hanxu, Jia Qingxuan, etc. Space robot workspace calculation based on Monte Carlo method [J]. *Spacecraft Engineering*, 2011, 20(04):79-85.
- [23]. Wang Xinghai, Zhou Yu. Numerical calculation of robot workspace [J]. *Robot*, 1988(01):50-53+49.DOI:10.13973/j.cnki.robot.1988.01.011.
- [24]. Fang Yuefa, Huang Zhen. Motion analysis of three-degree-of-freedom 3-RPS parallel robot mechanism [J]. *Mechanical Science and Technology*, 1997(01):86-92.