

Protection of Roads against Flash Floods (Case-Study)

N. Abdelazim¹

¹(Assistant Professor/ Canadian International College (CIC)/ Egypt)

Abstract: Flash Floods are a constant sudden threat to roads constructed in desert environment. It is significant to take action for the protection of such roads while preserving our natural resources. Such action includes data collection, analysis, and design of protection structures. This work introduces a study to protect roads in desert environment against Flash Floods and to benefit harvesting this water with practical application to a case study of a planned road surrounding a resort in the Eastern Desert in Egypt. Topographic, metrological and hydrological data was collected. Applying GIS computer program to the digital maps, the DEM is obtained. Complete system of hydrologic modeling programs is applied to set the morphological characteristics of the basins, determine the hyetograph of the design storm, trace flow direction and to accumulate flow discharges at every DEM cell. The system outputs include hydrographs, discharges, volumes, and peak time at any point of the study area. Analyzing the numerical results helped in choice and the hydraulic design of protection and storage structures at different locations of streams attacking the road. The used structures include Storage Barrier, Detention Barrier, Diversion Dyke, Culverts, Drainage Channels, and Sediment Traps.

Key Word: Hydrologic studies, Desert Environment, Flash Flood, Road Protection.

Date of Submission: 07-05-2022

Date of Acceptance: 22-05-2022

I. Introduction And Literature Review

During Flash Floods, millions of cubic meters of water move in a very short period with high velocity through steep streams resulting in high water power causing stream scour, land slip, structural failure, and hazards to man lives. Flash Flood attack gives no warning, and the short time between water-falls and Flash Flood attack makes it impossible for the authorities to take the rescue actions. Desert topography contains many Flash Flood ways (usually called Wadis) surrounded by hills. This helps in directing water quickly to unite in one stream. On the other hand, in desert environment, people like to construct their urban structures (buildings, roads, etc...) in these Wadis as they are always of regular slope terrain and surrounded and protected by hills. Except for heat related fatalities, more deaths occur from Flash Flood than any other hazard. Most people fail to realize the power of water. For example, 15 centimeters of fast-moving water can knock you off your feet. Therefore, the significance of protection of roads in the desert environment against such a natural catastrophe is vital.

Available, in the literature one may find many research works and field applications in studying Flash Flood. Doswell³ used measurements of heavy rain events in the Mediterranean from late 1995 to early 1996 to test a meso-scale numerical model as a potential operational tool in support of heavy precipitation forecasts. Studies at National Severe Storms Laboratory⁷ showed that meso-scale prediction models tend to perform best in situations with strong synoptic-scale signals and when dominated by topographic influences. Results gave considerable optimism about use of meso-scale model forecasts as guidance for flash flood forecasting. Brooks and Stensrud¹ defined heavy precipitation associated with Flash Floods to be ≥ 1 in/hr occurring over a short period of time. Droegemeier et al⁴ used a three-dimensional numerical cloud model to investigate the influence of storm-relative environmental helicity on convective storm structure and evolution. One most recent study is that by Heinselman and Schultz⁶ in early 2006 who analyzed the variability of summertime storms over central Arizona during 1997 and 1999 using Radar reflectivity mosaics from Phoenix and Flagstaff Weather Surveillance Radar Doppler (WSR-88D) reflectivity data. Data revealed six repeated storm development patterns or regimes. In 2020⁸, Helmy A. and Zohny O. conducted a two-dimensional HEC-RAS rainfall-runoff modeling for Ras-Gharib city to assess the effectiveness of a newly constructed culvert. Flow depth and velocities obtained were used to calculate flood intensities. They found a significant improvement in flood intensity values in Ras-Gharib city. In 2020, Prama M. et al⁹ studied flash floods in Wadi Dahab Basin, results indicated that Dahab is greatly vulnerable to flash flooding with a 72% approximate negative impact on infrastructure in the worst case scenario. In 2021, M. Abdel-Fattah et al¹⁰ discussed flash floods simulation and management in Wadi Abadi system, and they evaluated different concepts of flash floods mitigation in two flash flood events (scenarios). A single concentrated dam or group of distributed dams were assessed. Results showed

that both scenarios could mitigate flash floods at the downstream efficiently and the dams additionally managed the water harvest at the upstream sub-basins. The present study introduces a complete program to protect roads in the desert environment against Flash Floods and to benefit such natural water resources. It applies this program to a case study of a planned road surrounding a touristic resort in the Eastern Desert in Egypt. It is hoped to give aid to both design and field engineers although, as Stewart¹¹ said, "Flash Floods are considered by many to be acts of GOD beyond human ability to prevent".

II. Study Methodology

In this study, the aim is to protect a roadway from Flash Flood. Topographic, metrological and hydrological data is collected. Data is analyzed using GIS computer programs to be ready for use by Watershed Modeling System (WMS) in which Hydrologic Modeling System (HMS) is employed as a sub-routine. In the used system, the well known product of the Hydrologic Engineering Center (HEC-1) was the used HMS. When constructing a model within WMS, the first step is to import and process aerial photos or satellite images to get the Digital Map (DM). Second, DM is read by GIS computer programs (Arc-Catalog and Arc-Map) to produce the Digital Elevation Model (DEM). DEM is used to quickly delineate watershed boundaries. The flow direction for each of the DEM cells is determined and traced using the TOPAZ program. Calculating distances and slopes from the DEM data, TOPAZ determines the flow accumulation. The WMS simulates watersheds with points for outlets of basins, lines for the stream network, and polygons for the basin boundaries. Output data includes hydrographs, peak discharges, peak time and volume of water at any point to help in choice and design of the protection structures at points where Wadis attack the road.

III. Data Collection

Various techniques were used to collect data using special equipment and experienced personnel as shown hereafter:

Topographic Data: The study area is of 6 km² and is situated 35 km South of Qusier City by the Red Sea coast in eastern Egypt. It is desired to change road alignment to allow more space for the resort to lie between the road and Red Sea coast. With a 5 km beach, the resort consists of 5 luxury hotels, artificial lagoons, villas, sport area, golf courses, airport, educational area, and shopping centers.

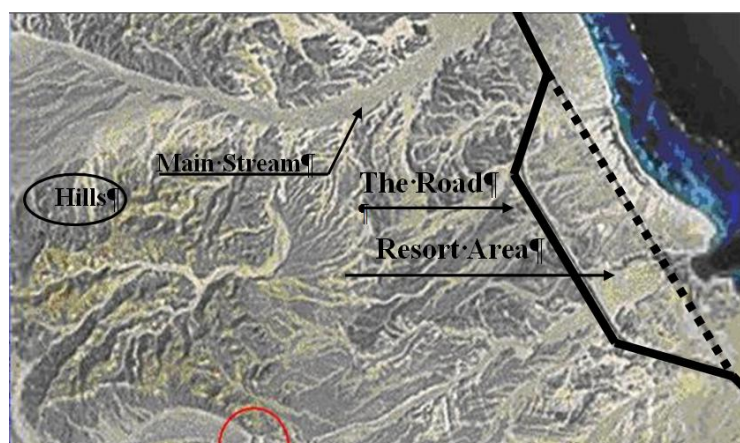

Figure no 1: Satellite Image of the Area under Study

Many Wadis cut through the resort area and raise problems of Flash Floods. The main Wadi is Sharm El-Quibli that attacks the resort center. Figure no 1 shows a satellite image of the area under study. The solid line gives the planned path of the road while the dashed line gives the old one. Hills, laterals, and main streams can easily be noted. Wadis issue from hills and go downhill towards the sea. Figure no 2 gives the Digital Map fed to the GIS programs (Arc Catalogue and Arc map) to be converted to DEM. In Arc catalogue, each contour line is given a reference level and stored in the GIS memory. Thus, when transferred from Arc catalogue to Arc map, the DEM could be formed. Imported on the WMS, the file could be read with its levels and the land shape determines water motion.

Metrological Data: Table no 1 and Figures (3 to 6) denote the collected and calculated data. This data constitutes a prime part of the input data file fed to the system. Metrological parameters include temperature (T), wind speed (W), relative humidity (RH), saturated vapor pressure (Ps), vapor pressure (Pa), and evaporation (E). The first three parameters were collected as raw data while the second three were calculated using equations (1), (2) and (3):

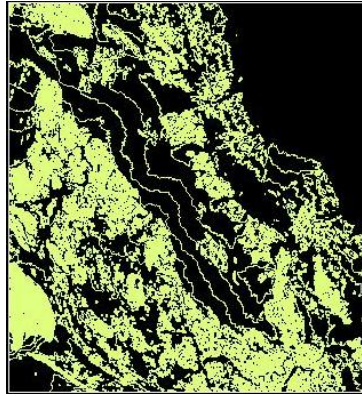

Figure no 2: Digital Map Fed to the GIS Program

$$P_s = 611 \exp \frac{17.27T}{237.3 + T} \tag{1}$$

$$P_a = RH * P_s \tag{2}$$

$$E = C (P_s - P_a) (1 + 0.1 W) \tag{3}$$

Table no 1: Collected and Calculated Data

Month	Mean			P _s Milli-bar	P _a Milli-bar	E (mm/d)
	T (°C)	W (Knots)	RH (%)			
January	6.1	6.9	71.0	941.9	668.8	179.1
February	8.5	10.0	54.3	1110.2	602.8	393.8
March	12.2	9.1	57.1	1421.6	811.8	452.0
April	21.5	0.0	39.6	2565.3	1016.0	601.3
May	20.4	12.1	45.4	2397.6	1089.0	1122.7
June	22.3	12.0	39.9	2693.5	1075.0	1382.0
July	23.4	0.0	56.6	2879.1	1630.0	484.9
August	24.7	12.4	50.9	3112.6	1584.0	1328.5
September	22.3	8.1	52.3	2693.5	1409.0	902.4
October	19.6	8.4	64.0	2281.8	1460.0	586.5
November	16.6	8.4	66.0	1889.8	1247.0	458.8
December	13.0	6.4	62.0	1498.3	928.9	362.3

Rainfall Data: The design of protection works is usually carried out based on the max (not average) rainfall (R_{max}) as the metrological stations are located away from basins and to take into consideration the high risk caused by Flash Flood. Data was analyzed to get R_{max} for different return periods using Weibull and Hazen equations (4) and (5):

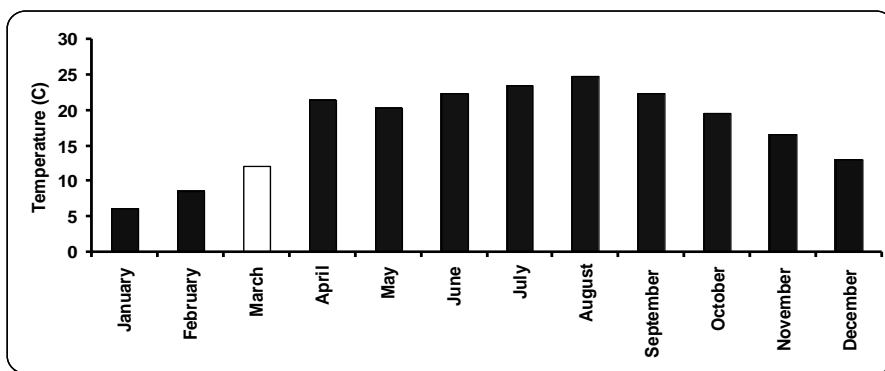

Figure no 3: Mean Monthly Temperature

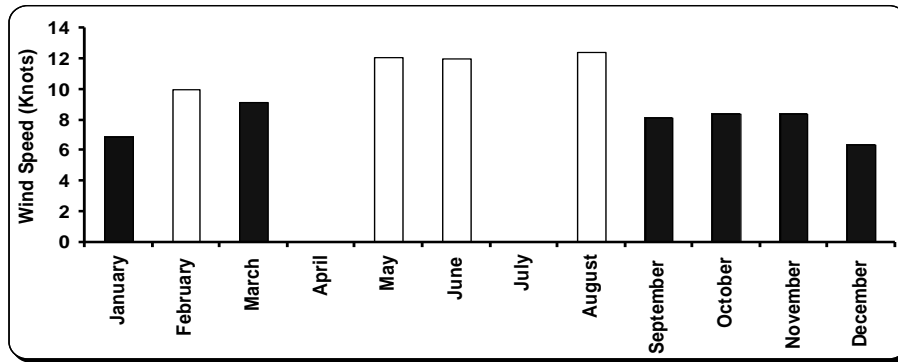

Figure no 4: Mean Monthly Wind Speed

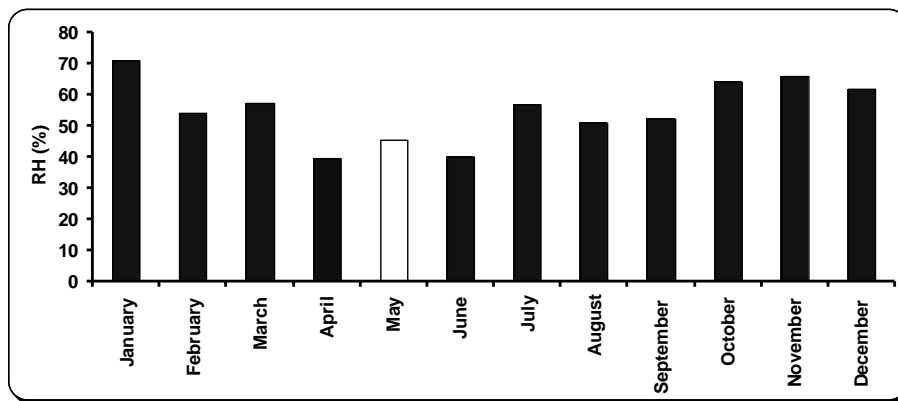

Figure no 5: Mean Monthly Relative Humidity

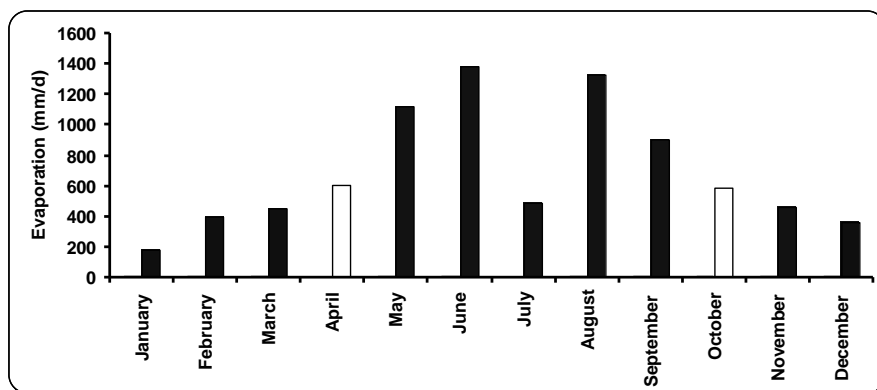

Figure no 6: Mean Monthly Evaporation

Weibull equation:

$$P_r = \frac{m}{n + 1} \tag{4}$$

Hazen equation:

$$P_r = \frac{2m - 1}{2n} \tag{5}$$

Where P_r is the probability, m is the no. of rank, and n is the no. of event.

Figures (7) and (8) give the statistical analysis using Weibull and Hazen methods respectively. Clear is that the rainfall depth for every return period calculated using Weibull method is larger than Hazen method (see Table no 2). Thus, the values of Weibull were considered for safety.

Table no 2: Rainfall Depths for Different Return Period

Period (year)	Probability	Rainfall (Weibull)	Rainfall (Hazen)
10	0.1	21	18
50	0.02	34	29
100	0.01	40	34

Based on the degree of risk and road lifetime, the design storm was considered based on a return period of 50 years. That is Rmax of the design storm is 34 mm. The storm was assumed to last for 120 min based on literature data. The Program was allowed to assume the most common hyetograph (Depth-Time graph) to simulate the considered design storm.

IV. Data Analysis

The system of programs gives tools that are organized into three groups. The first set is for manipulating the display. The second is used for creating and editing objects in the graphics window. The third group allows users to add graphical information to the graphics window.

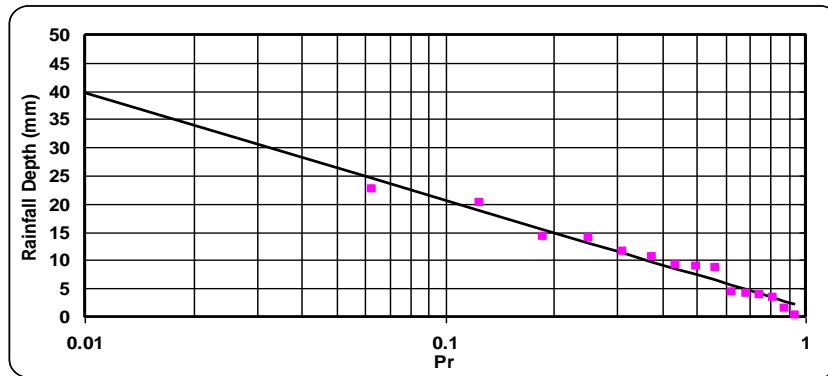

Figure no 7: Statistical Analysis Using Weibull Method

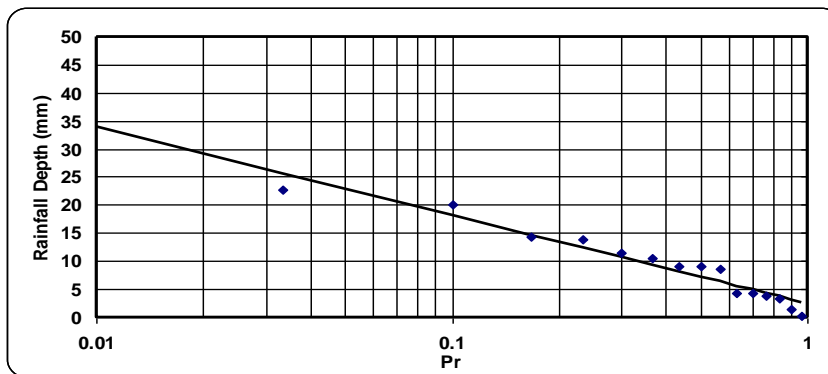

Figure no 8: Statistical Analysis Using Hazen Method

The DEM, used to delineate watershed boundaries, resulted in 7 Wadis, contain laterals with different ranks and the mainstream. One module computed basin parameters such as area and slope and the graphical user interface made it readable for HEC-1 models. Figure no 9 shows the output first delineation and Wadis' determination.

Figure no 10 gives the output morphological characteristics of Wadis together with SCS composite curve numbers computed from land use and soil layers. Wadis with mainstreams and laterals with all ranks are given in Figure no 11. The first prime system output is the hydrograph computed and drawn using HEC-1 built-in WMS. Figure no 12 gives the output hydrographs for all Wadis. A simple click on any Wadi can enlarge its hydrograph accumulated through laterals and mainstream from the basin origin to the section of calculation.

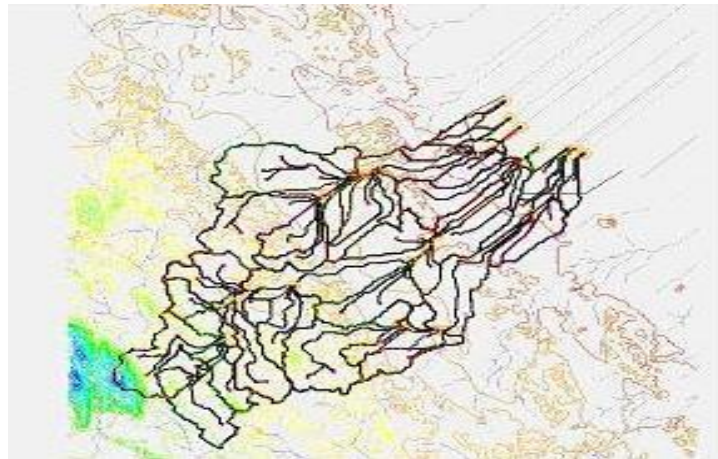

Figure no 9: First Delineation and Wadis' Determination



Figure no 10: Output Morphological Characteristics

The second prime system output is the land cross section. A simple click on any point results in the cross section which is of great importance in the selection of protection structure. Figure no13 gives the output cross section at a point in Wadi No. 1.

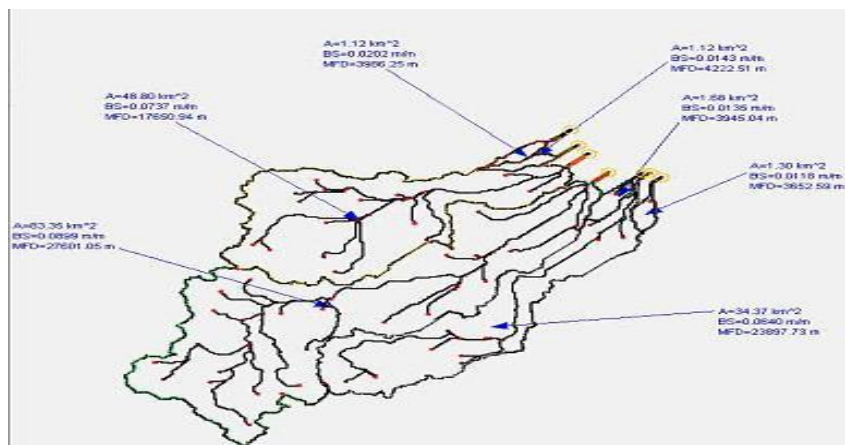

Figure no 11: Output Wadis , Mainstreams and Laterals

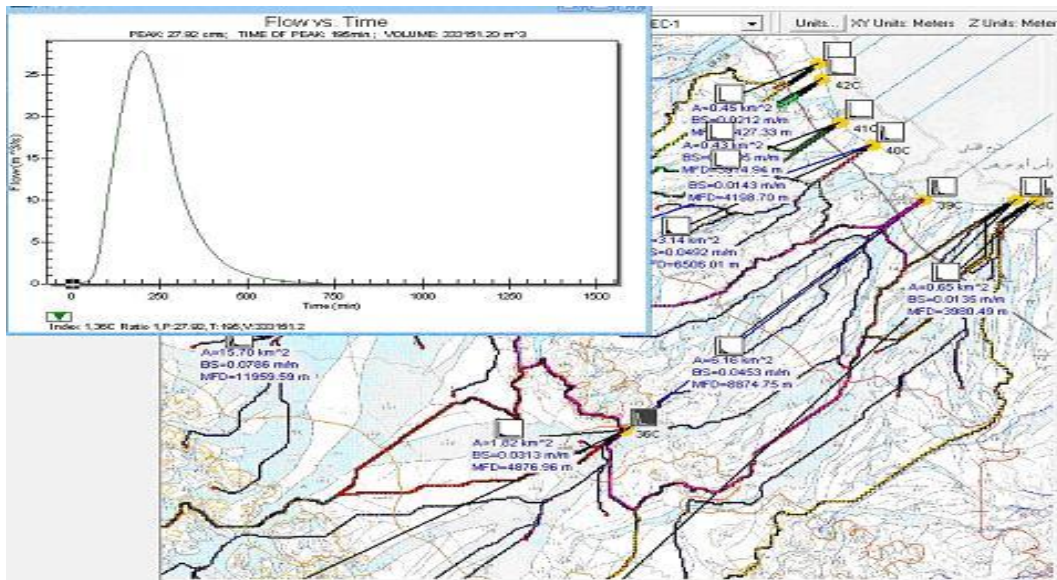

Figure no 12: Output Hydrographs of Wadis

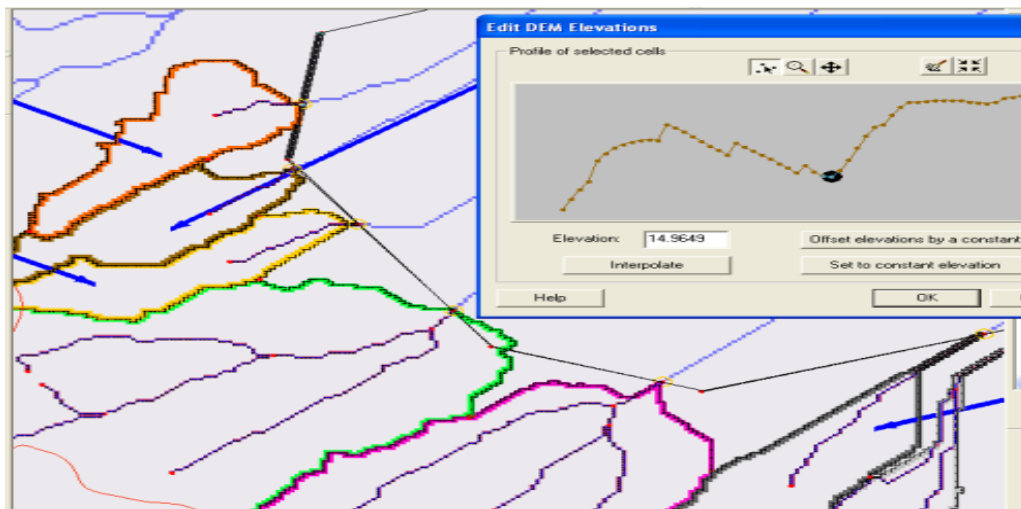

Figure no 13: Output Cross Section at a Point in Wadi No. 1.

V. Suggested protection works

Protection of roads against Flash Floods is always achieved using well known structures such as crossing works (culverts and Irish crossing), retaining works (solid barriers), detention works (hollow barriers), orientation works (walls and ditches), and sedimentation works (sediment traps). The problem is always which to choose and where to install. The system of programs is able to install structures, and use the flood routing technique to give the hydrograph upstream and downstream the suggested structure. Table no 3 shows some characteristics of the 7 Wadis.

Table no 3: Characteristics of Wadis

Wadi No.	Area (km ²)	Slope (m/m)	Discharge (m ³ /sec)	Volume (m ³)
1	1.13	0.0214	1.08	7322
2	1.12	0.0202	0.92	6836
3	1.12	0.0143	0.71	7006
4	48.8	0.0737		
4-1 Upstream Storage Barrier			58.52	780864
4-2 Reaching Box culvert			7.92	66020
5	83.35	0.0899		
5-1 Upstream Detention barrier			10.05	114454

Wadi No.	Area (km ²)	Slope (m/m)	Discharge (m ³ /sec)	Volume (m ³)
5-2 Reaching box culvert			21.15	245940
6	1.68	0.0135	1.16	13888
7	34.37	0.064	12.6	284625

The following are samples of the suggested structure for the case study (see Figures 14 to 18):

- **Wadis No. (1), (2) and (3):** Due to their narrow well defined cross sections and small discharges, one pipe culvert is used to pass about 1m³/sec under the road for every Wadi.
- **Wadi No. (4):** A storage barrier to harvest about 800,000 m³ is used in a selected rather narrow cross section. The storage barrier is followed by a one vent box culvert to pass 7.92 m³/sec under the road.
- **Wadi No. (5):** Using a diversion dike, the Wadi is diverted to the stream of Wadi No. (4). Detention barrier was used to slow down water to pass either 7.92 m³/sec from Wadi No. (4) or 21.15 m³/sec from Wadi No. (5) through the culvert. The Detention barrier was constructed using Gabions.
- **Wadis No. (6) and (7):** The two Wadis were diverted from the road using a drainage channel and directed to the Red Sea. Drops were used to ensure milder slope for the drainage channel.

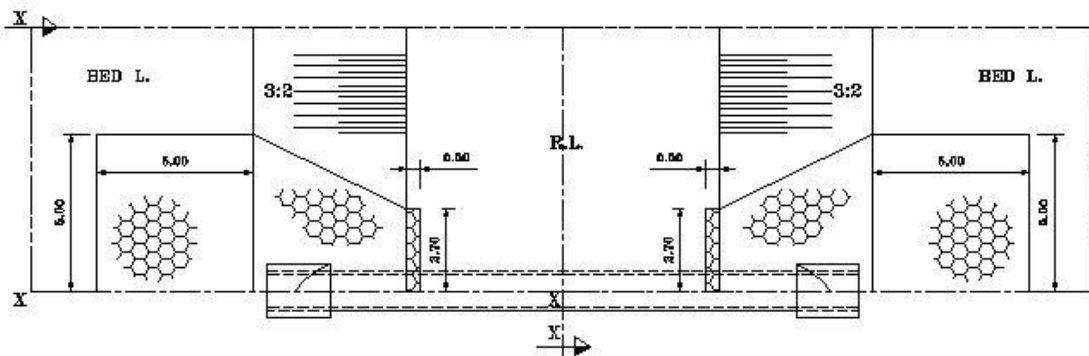

Figure no 14: Culvert at Wadis (1), (2), (3)

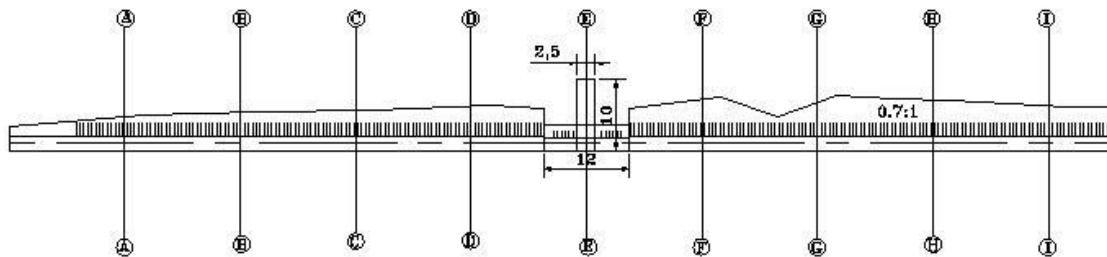

Figure no 15: Plan of Storage Barrier and Escape Spillway at Wadi (4)

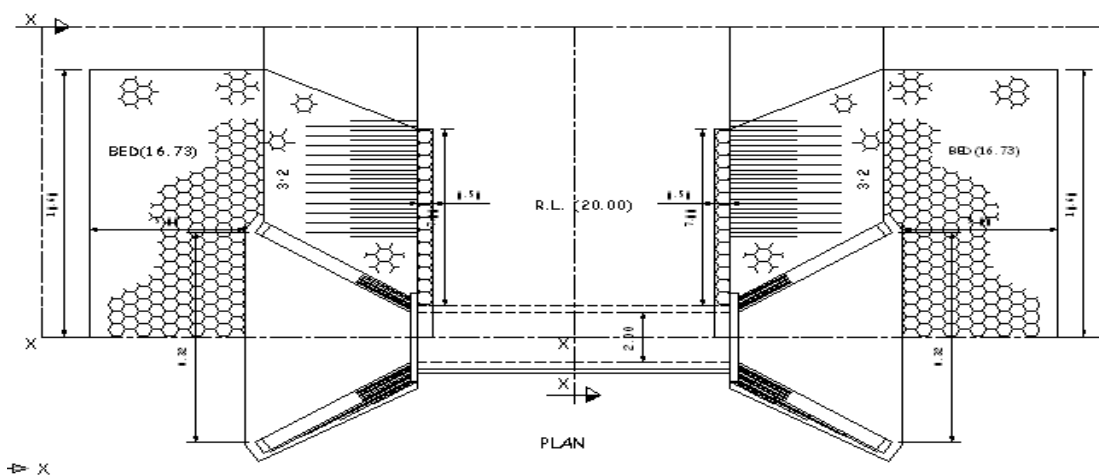

Figure no 16: Box Culvert at Wadi (4)

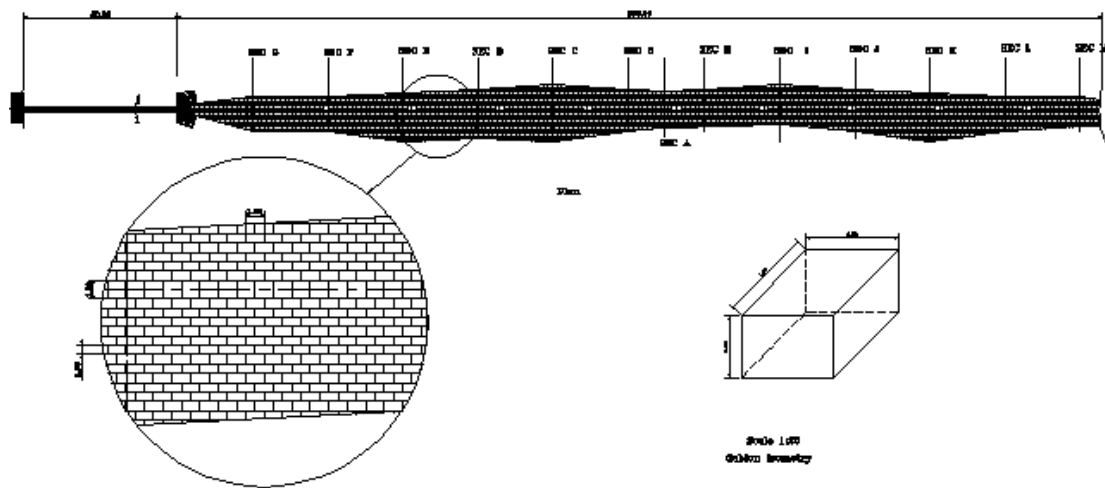

Figure no 17: Views of Gabions Barrier at Wadi (5)

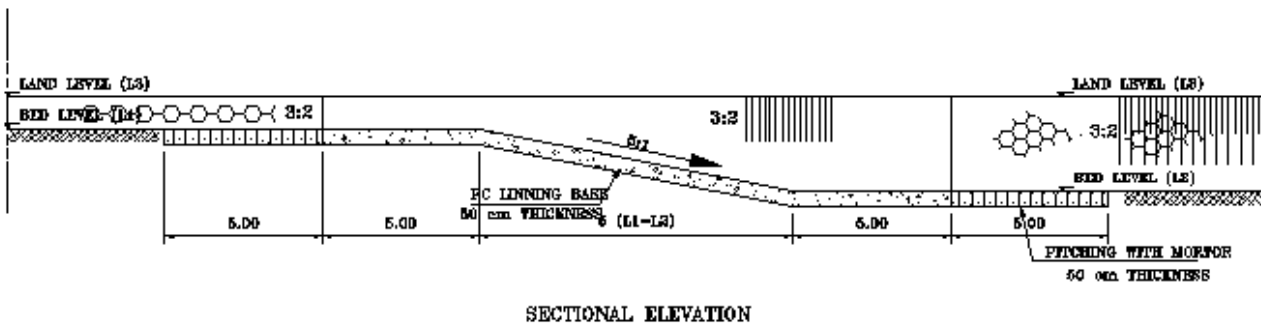

Figure no 18 (a): Drops in the Drainage Channel at Wadi (6, 7)

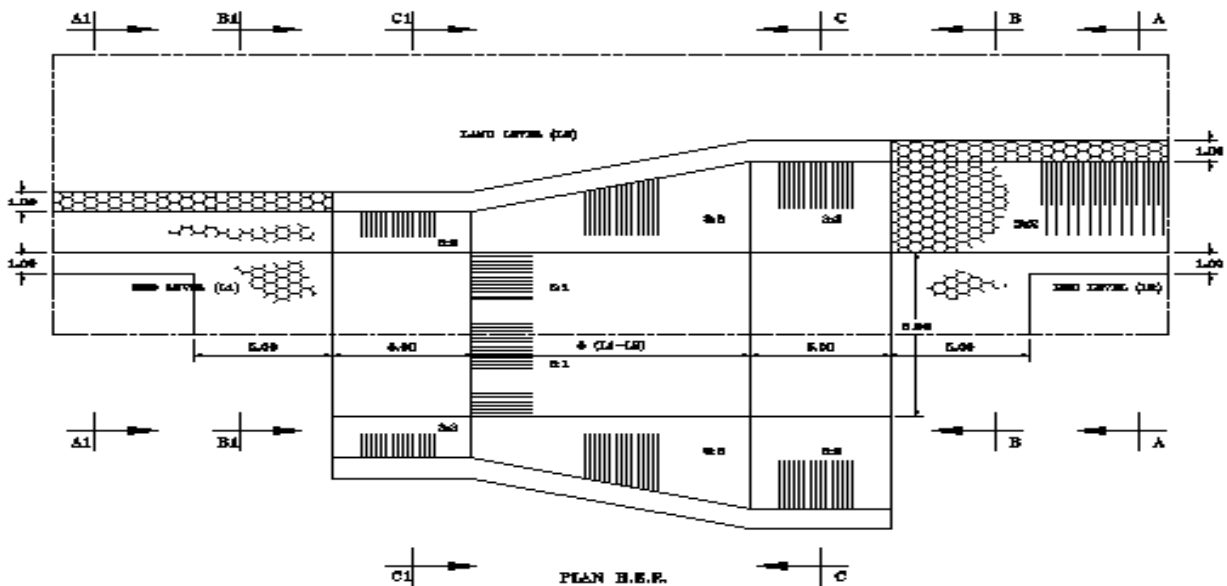

Figure no 18 (b): Drops in the Drainage Channel at Wadi (6, 7)

VI. Conclusions

A computational study was conducted to compute the hydrographs and volumes of water for every Wadi in the study area around a developed road by the Red Sea coast.

1. A computer system was constructed that can perform the following:
 - Read the Digital Map to give the DEM.
 - Compute hydrographs at any section of the Wadi.
 - Accept installation of any protection structure.
 - Apply the flood routing technique to determine the change in hydrographs due to installation of structures.
2. Based on the computed hydrographs and cross sections of different streams, protection structures were suggested.

References

- [1]. Brooks, H. and Stensrud D., (2000) "Climatology of heavy rain events in the United States from hourly precipitation observations", Monthly Weather Review, Vol. 128, pp 1194-1201.
- [2]. Davies-Jones R., (2002) "Linear and nonlinear propagation of super cell storms", Journal of the Atmospheric Sciences, Vol. 59, pp 3178-3205.
- [3]. Doswell C., Brooks A, and Maddox R., (1996) "Flash-Flood forecasting: An ingredients-based methodology". Journal of Weather and Forecasting, Vol. 11, pp 360-381.
- [4]. Droegemeier K., Lazarus K., and Davies-Jones R., (1993) "The influence of helicity on numerically modelled storms", Monthly Weather Review, Vol. 121, pp 2005-2029.
- [5]. Errico R., Stensrud D., and Raeder K., (2001) "Estimation of the error statistics of precipitation produced by convective parameterization schemes for application to the variational assimilation of precipitation observations Quarterly", Journal of the Royal Meteorological Society, Vol. 127, pp 2495-2512.
- [6]. Heinselman P. and Schultz D., (2006) "Intra-seasonal variability of summertime storms over central Arizona during 1997 and 1999", Journal of Weather and Forecasting, Vol. 21, pp 559-578.
- [7]. National Severe Storm Laboratory (1997) " NSSL scientist studies for Western Mediterranean flash floods", http://www.nssl.noaa.gov/briefings/vol3_no1/flashflood.html.
- [8]. Helmy A. and Zohny O., (2020), "Flash Flood Risk Assessment in Egypt", research gate, book Flash Floods in Egypt (pp.253-312), DOI:10.1007/978-3-030-29635-3_13.
- [9]. Prama M. Omran A. Schröder D. Abouelmagd A., (2020), "Vulnerability assessment of flash floods in Wadi Dahab Basin, Egypt", Springer, Environmental Earth Sciences, pp 79:114, <https://doi.org/10.1007/s12665-020-8860-5>
- [10]. M. Abdel-Fattah, S.A. Kantoush and T. Sumi, (2021), "FLASH FLOODS MITIGATION USING STRUCTURAL MEASURES IN EGYPT", ICE Virtual Library, ISBN 978-0-7277-6525-3, <https://doi.org/10.1680/oicwe.65253.295>.
- [11]. Stewart K.G, "Coping with flash floods", Series 2. Environmental Security - Vol. 77, pp 313, <https://link.springer.com/content/pdf/10.1007%2F978-94-010-0918-8.pdf>.

N. Abdelazim. "Protection of Roads against Flash Floods (Case-Study)". *IOSR Journal of Mechanical and Civil Engineering (IOSR-JMCE)*, 19(3), 2022, pp. 21-30.