

## **A computational study on nonlinear curve-fitted equation for estimating gasoline –engine exhausts emissions**

**Eng. Waleed K. Al Faraj**

*Navigation Department The Higher Institute for Telecommunication and Navigation*  
*Corresponding Author: Eng. Waleed K. Al Faraj*

---

Date of Submission: 26-12-2018

Date of acceptance: 11-01-2019

---

### **I. Introduction**

Several researchers have explored ways to control and reduce automotive emissions in different vehicles. The levels of emission of automobiles have been substantially reduced in the last two decades through the implementation of control devices. Indexes note an 87% reduction for new cars as well as 78% for used cars [2]. For example, cars, trucks and off-road vehicles hold the responsibility of approximately 40—50% of HC or VOC emissions, 50 % of NOX emissions and 80—90% of the CO emissions in the United States [3]. During a standard test, the first minute of operation in spark-ignition (SI) engines was found to make the largest contribution (90%) to HC emission [4].

There is a great concern about traffic-related pollution emissions because of their serious hazards to people's health and the environment. One of the problems resulting from the air quality caused by these emissions is respiratory and cardiovascular disease. There have been a continuous development of strict regulations to organized technology projects investigating species and radicals formation in engine combustion with the aim of reducing these emissions. However, the polluting emissions, mainly hydrocarbon (HC), carbon monoxide (CO), and nitrogen oxide (NOX), of SI engines exceed the limits imposed by most regulatory boards. Therefore, substantial additional reductions and control of pollutant emission levels are required by future emission legislations. There is a general consensus among world scientists and engineers that upstream emissions of electric drive vehicles are of interest.

There are efforts to maintain air quality by subjecting vehicle emissions to meeting certain standards for approval before usage. However, to the author's knowledge, these efforts have not been initiated in Kuwait for passenger cars and light vehicles even though they will surely help achieve a considerable reduction in air pollution resulting from cars. However, the reduction of vehicle emissions should be one step of a larger strategy to overcome the negative health and environmental effects of air pollution by all sectors.

There are three main factors that determine the relative amounts of varying emission pollutants. These are the composition of fuel (specifically fuel —air equivalence ratio), engine design and operating conditions. A number of authors [1, 5, 6] reached the conclusion of leaner mixtures giving lower quantities of CO and NO. The risk with leaner mixtures is that if they are too lean, there are risks of causing the engine to misfire, giving rise to higher HC emissions. While the best economy is obtained with a mixture somewhat leaner than stoichiometric, the authors suggest that obtaining maximum power requires the engine to operate near stoichiometric (slightly rich).

Different authors propose a variety of reaction mechanisms in terms of engine emission species, especially NO formation. Some of these authors are Heywood [1], Horlock-Benson [5], Millar et al. [7] Zeldovich (2 reactions), Extended Zeldovich (3 reactions), super extended Zeldovich (67 reactions) and Lavoie (7 reactions). The operating conditions and accuracy of predictions are essential factors of these equations. On the same note, CO concentrations in exhaust gases are recognized to be kinetically controlled, because CO concentrations are lower than the maximum value measured within the combustion chamber but higher than the corresponding equilibrium value. For this, Benson [2] and Sher et al. [8] introduced the COFAC factor. This is used to predict CO concentrations, which lies between the peak and exhaust equilibrium values. Horlock-Benson [5], Heywood [1] and Turns [9] thoroughly discuss more detailed information concerning pollution formation mechanism and their chemical kinetic rate of carbon monoxides, organic compounds, and particulates. The efficiency and power of the engine are also as fundamental as the reduction of engine emission.

The difference between rich, lean, and stoichiometric engine operation lies in the air to fuel ratio. Stoichiometric engine operation is defined as having the chemically correct amount of air in the combustion chamber during combustion. Thus, the production of CO<sub>2</sub> and water would result from the perfect combustion. However, perfect combustion is not possible when the results include the production of HC, CO, NOX, PM and

water. A rich-burn engine is singularized by excess fuel in the combustion chamber during combustion. On the other hand, a lean-burn engine is identified by excess air in the combustion chamber during combustion, which results in an oxygen rich exhaust. Gasoline engines can be operated in all three modes of operation.

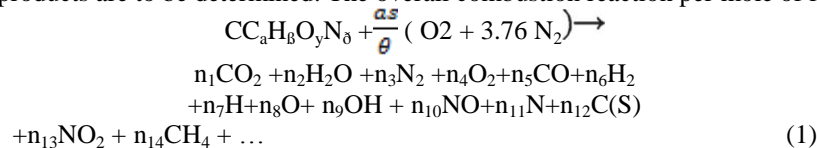
The reviewed literature depicts a gap in published work regarding a simple equation of the effect of equivalence ratio on performance of Otto cycle. As a result of this gap, the aim of this paper is to present a theoretical approach that works towards a development of a computational model of combustion in SI engine in order to generate curve-fitted equations for estimating emission and performance of gasoline operated internal combustion engines. The validation of model is being compared by Ferguson et al. [6].

## II. Analysis

A satisfactory thermodynamic model will present an understanding of the performance and emission of internal combustion engines. Simulations software is a powerful tool for studying and optimizing internal combustion engines systems. This section presents the thermodynamics of combustion as well as suitable models for applications to internal combustion engines. The properties of multicomponent ideal gas and the equilibrium combustion component is also presented.

### 2.1 General Chemical Equilibrium

A combustion problem that has many product species is often considered. In this case, the fuel is initially mixed with air with an equivalence ratio  $D$ , and then the products of reaction are assumed to be in equilibrium at temperature  $T$  and pressure  $P$  after the combustion process. The composition and thermodynamic properties of the products are to be determined. The overall combustion reaction per mole of fuel is:



The condition for equilibrium is usually stated in terms of thermodynamic functions such as the minimization of the Gibbs or Helmholtz free energy or the Maximization of entropy. If temperature and pressure are used to specify a thermodynamic state, the Gibbs free energy is most easily minimized since temperature and pressure are its fundamental variables. For a product mixture of  $n$  species, the Gibbs free energy is:

$$g = \sum_j^n \mu_j n_j \quad (\text{kJ}) \tag{2}$$

where the chemical potential,  $\mu_j$ , of species  $j$  is defined by

$$\mu_j = \left( \frac{\delta g}{\delta n_j} \right) T_i P_i n_j \neq j \quad (\text{KJ/Kmol}) \tag{3}$$

The equilibrium state is determined by minimizing the Gibbs free energy subject to the constraints imposed by atom conservation, that is,

$$i \quad b'_i = \sum_{j=1}^n a_{ij} n_j \quad i = 1, \dots, I \tag{4}$$

or

$$b_i - b'_i = 0 \quad i = 1, \dots, I \tag{5}$$

where  $I$  is the number of atom types,  $a_{ij}$  is the number of atoms of element  $i$  in species  $j$ ,  $b_i$  is the number of atoms of element  $i$  in the reactants, and

$$b_i = \sum_{j=1}^n a_{ij} n_j \tag{6}$$

is the number of atoms of element  $i$  in the products.

Defining a term  $G$  to be

$$G = g + \sum_{i=1}^I \lambda_i (b_i - b'_i) \tag{7}$$

Where  $\lambda_i$  are Lagrangian multipliers, the condition for equilibrium become

$$\delta G = \sum_{j=1}^n \left( \mu_j + \sum_{i=1}^I \lambda_i a_{ij} \right) \delta n_j + \sum_{i=1}^I (b_i - b'_i) \delta \lambda_i = 0 \quad (8)$$

Treating the variations  $\delta n_j$  and  $\delta \lambda_i$  as independent

$$\mu_j + \sum_{i=1}^I \lambda_i a_{ij} = 0 \quad j=1, \dots, n \quad (9)$$

For ideal gases

$$\mu_j = \mu_j^\circ + R_u T \ln \left( \frac{n_j}{N} \right) + R_u T \ln \left( \frac{P}{P_0} \right) \quad (10)$$

so that

$$\frac{\mu_j^\circ}{R_u T} + \ln \left( \frac{n_j}{N} \right) + \ln \left( \frac{P}{P_0} \right) + \sum_{i=1}^I \pi_i a_{ij} = 0 \quad j=1, \dots, n \quad (11)$$

where

$$\pi_i = \lambda_i / R_u T \quad (12)$$

To determine the equilibrium composition using the Lagrange multiplier approach, we have to solve a set of  $(n + I + 1)$  equations. For a given temperature and pressure  $(T, P)$  Equation 11 is a set of  $n$  equations for the  $n$  unknown  $n_j$ ,  $I$  unknown  $\pi_i$ , and  $N$

Equation 5 provides an additional  $I$  equation and we close the set with

$$N = \sum_{j=1}^n n_j$$

Once the composition of the products has been determined, we can now compute the thermodynamic properties of the equilibrium mixture. Recall that any two of the independent properties  $T, P, H, S, U,$  and  $V$  specify the thermodynamic state. For example, for constant pressure combustion, the enthalpy is known instead of the temperature. For this case we include an equation for known enthalpy to our set of equations,

$$H = \sum_{j=1}^n n_j \bar{h}_j \quad (14)$$

For an isentropic compression or expansion, or expansion to a specified pressure, the entropy is given instead of enthalpy or temperature. In this case we have

$$S = \sum_{j=1}^n n_j \left[ s_j^\circ - R_u \ln \left( \frac{n_j}{N} \right) - R_u \ln \left( \frac{P}{P_0} \right) \right] \quad (15)$$

Finally, if in any case specific volume rather than pressure is known, then we have to minimize the Helmholtz free energy. In this case a similar analysis (Gordon and McBride, 1971) shows that Equation 11 is replaced by

$$\frac{\mu_j^\circ}{R_u T} + \ln \left( \frac{n_j}{N} \right) + \ln \left( \frac{RT}{P_0 v} \right) + \sum_{i=1}^I \pi_i a_{ij} = 0 \quad j=1, \dots, n \quad (16)$$

For constant volume combustion, the internal energy is known, so we include

$$U = \sum_{j=1}^n n_j (\bar{h}_j - R_u T) \quad (17)$$

For an isentropic expansion or compression to a specified volume  $v$  we include

$$S = \sum_{j=1}^n n_j \left[ s_j^\circ - R_u \ln \left( \frac{n_j}{N} \right) - R_u \ln \left( \frac{RT}{P_0 v} \right) \right] \quad (18)$$

Solution of these problems for practical application requires numerical iteration on a computer, i.e., TRANS72 for hydrocarbon-air mixtures [10].

## 2.2 Four-stroke Otto Cycle

In this work, it is instructive to consider the Otto fuel-air cycle with the ideal inlet and exhaust processes. Hence, the intake pressure  $P_i$ , the exhaust pressure  $P_e$ , and the intake temperature  $T_i$  are the independent variables. Hence the cycle is consisted of the following processes:

- 1 to 2 Isentropic compression
- 2 to 3 Constant pressure heat addition
- 3 to 4 Isentropic expansion
- 4 to 5 Constant cylinder volume blowdown
- 5 to 6 Constant pressure exhaustion
- 6 to 7 Constant cylinder volume reversion
- 7 to 1 Constant pressure induction

Define the residual fraction as follows

$$f = \frac{1 V_4}{r V_6} \tag{19}$$

The energy equation applied to the cylinder control volume during intake is given by

$$h_1 = f [h_6 + (P_i - P_e) v_6] + (1 - f) h_i \tag{20}$$

and, of course, it is still true that if the pressure drop across the intake valves is neglected

$$P_1 = P_i \tag{21}$$

The volumetric efficiency and pumping work are

$$\eta_{vol} = \frac{m_i}{\rho_i V_d} = \frac{r(1-f)}{(r-1)v_1} \tag{22}$$

$$P_{mep} = p_e - p_i \tag{23}$$

Finally, the net imep and thermal efficiency are

$$(imep)_{net} = imep - pmep \tag{24}$$

$$\eta_{net} = \eta \left( 1 - \frac{pmep}{imep} \right) \tag{25}$$

The inputs to a four-stroke Otto fuel-air cycle are the compression ratio  $r$ , the fuel-air equivalence ratio  $\phi$ , the intake pressure  $P_i$ , the exhaust pressure  $P_e$ , the intake temperature  $T_i$ , and the fuel type. This analysis of the four-stroke fuel-air requires iteration.

Nitrogen oxidizes are generally formed at high temperatures when  $N_2$  is oxidized in air. This reaction is governed by the Zeldovich Mechanism as shown by the following equations:



Typically, if combustion temperature and residence time are minimized and the appropriate amount of air is used, NO emissions will be small [11].

### III. Results And Discussion

Figure 4 depicts how the equivalence ratio affects the maximum temperature of an SI engine. The maximum temperature and the equivalence ratio increased simultaneously until it reached maximum value slightly above stoichiometric condition and then decreased. The maximum temperature is at slightly rich equivalence ratio mixture which is a result of both the heat of combustion and the heat capacity of the generated products

compositions  $(N^*Cp)_p$  reducing beyond the stoichiometric condition. The decrease in heat capacity of the mixture is dominated by the decrease in number of product moles formed per mole of fuel burned. It should be noted that the maximum temperature occurs at stoichiometric  $\phi = 1$ ) in the absence of dissociation. With dissociation effects, the maximum temperature occurs when the mixture is slightly rich. In addition, the dissociation decreases the maximum temperature.

The computed peak pressure in a spark ignition engine dependence on equivalence ratio is shown in Figure 5. The maximum pressure increases monotonically with the equivalence ratio. The peak pressure inside an engine depends on several factors. This includes inlet charge conditions, compression ratio, and amount of heat supplied by fuel and others. In this work, the engine speed, compression ratio, and inlet conditions are kept constant. Hence the main reason for the increase of peak pressure with equivalence ratio is the high heat generated inside the engine at higher values of equivalence ratios. The advantage of increasing the peak pressure is the increase of specific power which improves the acceleration of the vehicle.

Figure 6 shows the main calculated emission species from an SI engine and its variation with fuel-air equivalence ratio. The spark-ignition engines are normally operated close to stoichiometric or slightly fuel-rich mixture in order to ensure smooth operation.  $CO_2$  is one of the major components of the exhaust in the hydrocarbon fuel combustion. It is considered a major greenhouse gas. As the equivalence ratio increases,  $CO_2$  levels increases until it reaches its maximum value close to stoichiometric and then decreases. The reason of the increase level is that more fuel is oxidized and converted to  $CO_2$  with the increase in equivalence ratio level. However, increasing more fuel (beyond stoichiometric) will result in insufficient oxygen to burn all the carbon in fuel to  $CO_2$  and starts to generate CO and unburned hydrocarbon.

The carbon monoxide (CO) is generated when the engine is operated with a fuel rich equivalence ratio significantly, as shown in Figure 6. The main reason for this generation is that there is no enough oxygen to convert all carbon in the fuel to  $CO_2$ ; some fuel does not get burned and some carbon ends up as CO. In addition, the presence of CO in the exhaust indicates lost chemical energy that was not fully utilized in the engine.

The oxygen level also varies with equivalence ratio. At low equivalence ratio levels more oxygen presents in the engines while this levels start to decrease at higher levels of equivalence ratio because more oxygen is consumed to convert the carbon in the fuel into  $CO_2$  and CO. The presence of  $CO_2$  and CO in the gas mixture tends to prevent the dissociation of  $CO_2$  at high temperatures, which is noticeable in the fuel-rich mixture. However, dissociation of burnt gases does not occur in the lean-fuel mixture due to the relatively low temperature produced by the combustion process which is too low for dissociation.

Figure 7 presents the minor species distributions for gasoline-air combustion at the maximum temperature and pressure. It can be seen that the level of the hydroxyl radical OH is more than an order of magnitude greater than the O atom and that both peak slightly lean of stoichiometric condition ( $0.9 < \phi < 1$ ). The high levels of O and OH radicals in the lean region result in enhancing the kinetics of NO formation. Equilibrium NO concentration is decreased with the increase in equivalence ratio. However, in realistic internal combustion engines, NO levels are well below the equilibrium concentration because of the relatively slow formation reaction. The nitrogen oxide reduction comes to a complete stop when the engine operates in lean conditions because the ample oxygen in the exhaust gas is used to oxidize the unburned hydrocarbon and the carbon monoxide.

Figure 8 shows the effect of equivalence ratio on the indicated mean effective pressure of an SI engine. As is evident in Figure 8, the indicated mean effective pressure increases when the equivalence ratio increases, peaks at slightly rich mixture and decreases after that. The availability of fuel limits the combustion process at very low equivalence ratios. However, at very high equivalency ratios, the availability of oxygen in the gas mixture to complete the combustion is what limits the combustion process. At intermediate equivalence ratios, the ease of forming free radicals limits the combustion process to a certain extent. Running slightly rich means that there is more fuel available to accomplish this. These factors combine to cause the observed maximum in the IMEP as a function of equivalence ratio. The decrease afterwards in the IMEP is possibly due to the poor turbulence and mixing characteristics of the combustion chamber as well as mixture preparation and charge cooling.

Figure 9 presents the specific net work output in a spark ignition engine as a function of equivalence ratio. It is shown from the Figure 9 that the specific net work output increases with the equivalence ratio over the studied range [ $0.8 \leq \phi \leq 1.21$ ]. For the value of equivalence ratio below stoichiometric ( $0 < \phi$ ), the specific net

work output increases more rapidly than values the rich mixture values of equivalence ratio. This is due to the higher pressure and temperature values generated inside the engine cylinder operating at higher equivalence ratio.

Figure 10 shows that thermal efficiency ( $\eta_{th}$ ) and the volumetric efficiency ( $\eta_{vol}$ ) as a function of equivalence ratio. As it shown, the thermal efficiency tends to decrease with equivalence ratio beyond studied. Thermal efficiency is work-out divided by energy-input. In the present case, the input energy is the product of the mass of fuel and the lower heating value. A greater amount of fuel does not burn when the mixture is made richer. The energy contained in the bonds of this fuel is counted in the energy-input term but does not contribute to the workout since it does not burn, and hence the thermal efficiency decreases. The power output decreases greatly at equivalence ratios that are too lean. This causes the thermal efficiency to drop. A maximum value of thermal efficiency is achieved slightly rich of stoichiometric and is caused by these two factors at an intermediate equivalence ratio.

The depiction of a weak correlation between volumetric efficiency (TIVOI) and equivalence ratio is shown in Figure 10. This weakness extends to the relation between the slight increase in the volumetric efficiency as you move to very rich or very lean values of the equivalence ratio. There is very little fuel in the mixture at very lean conditions. As a result, the cylinder consumes a larger amount of air for a given amount of mixture. The effects of charge cooling may be significant at very high equivalence ratios. This temperature drop increases the density of the mixture, therefore increasing volumetric efficiency. However, the weakness of these trends requires further research and tests to confirm.

Finally, all the above emissions values have been plotted against the equivalence ratio and then curve fitted assuming 2nd and 3rd degree quadratic functions with (t) as follows:

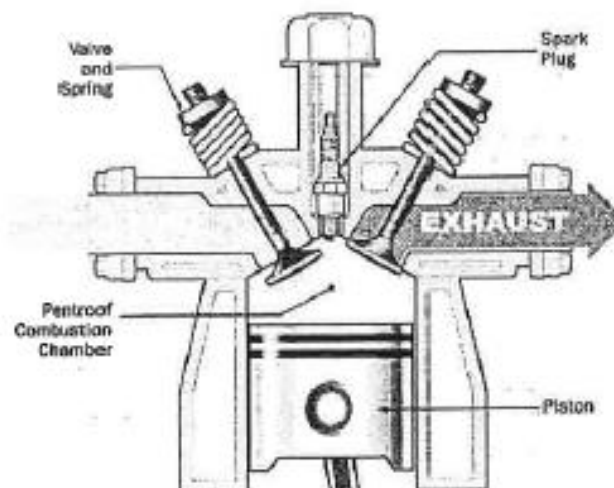
$$\Lambda = a_0 + a_1\Phi + a_2\Phi^2 + a_3\Phi^3 \quad (27)$$

where  $\Lambda = \{CO_2, H_2O, N_2, O_2, CO, H_2, H, O, OH, NO\}$ . The curve fitting coefficients, i.e. m, al, etc..., for the several functions are given in Table 1 and found by EES program.

#### IV. Conclusions

A general gasoline engine simulation technique has been used to model power cycle and emission. The equivalence ratio has been changed from lean mixture conditions to rich mixture condition. Linear regression technique has been used to derive simple equations that can estimate pollution emissions. Thermal efficiency, volumetric efficiency and specific work have also been derived. The following conclusions are drawn from the present work:

- a) The peak temperature and the indicated mean effective pressure increases with equivalence ratio up to a slightly rich mixture and then decreases.
- b) The maximum pressure and the specific net work increase monotonically with equivalence ratio.
- c) The CO and 1-12 emissions increase towards rich mixture.
- d) NO concentration varies with equivalence ratio and it increases at slightly lean stoichiometric mixture and reduces toward richer mixture.
- e) Both the volumetric efficiency and the net thermal efficiency decreases with equivalence ratio.



**Figure 1:** Schematic diagram of an internal combustion engine (From HowStuffWorks 2003)

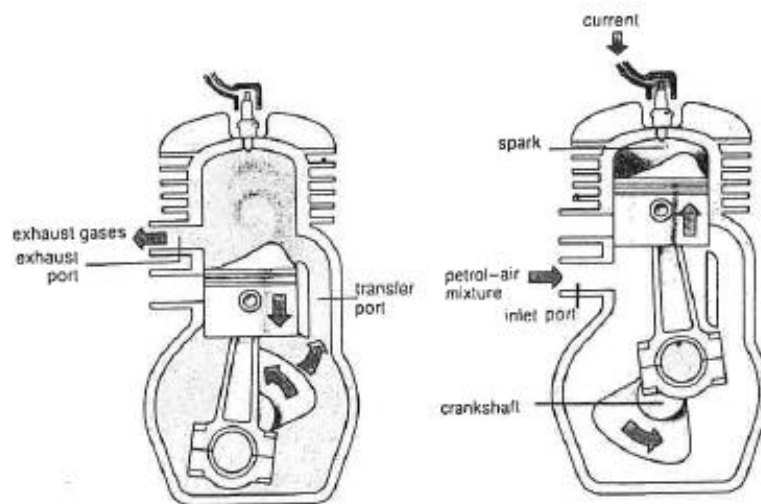


Figure 2: Two-stroke internal combustion engine (From schoolworkhelper.net)

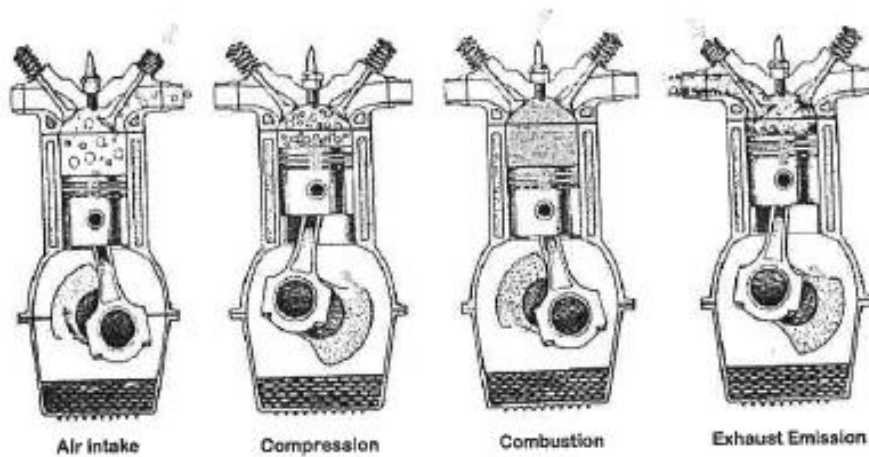


Figure 3: Four-stroke internal combustion engine (From schoolworkhelper.net)

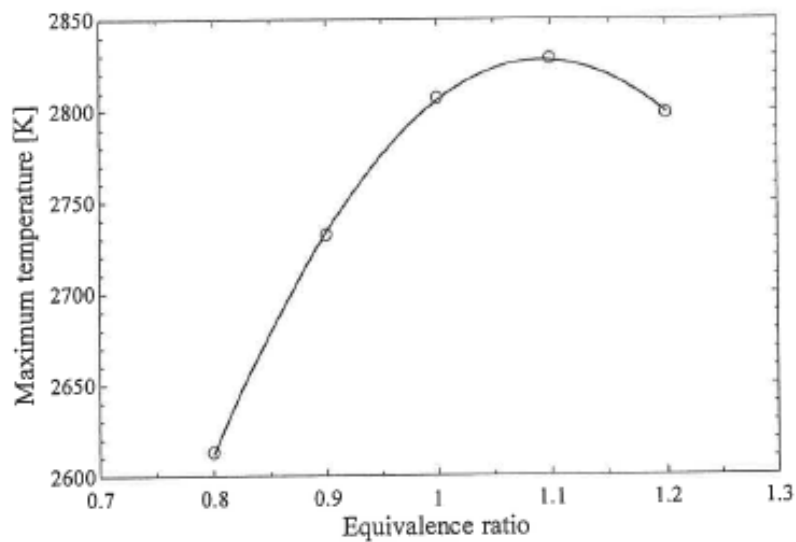
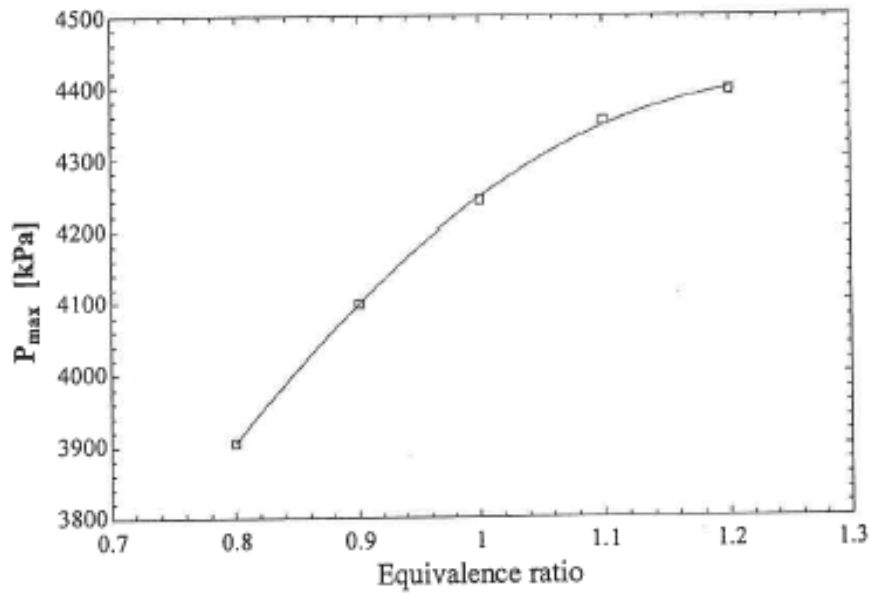
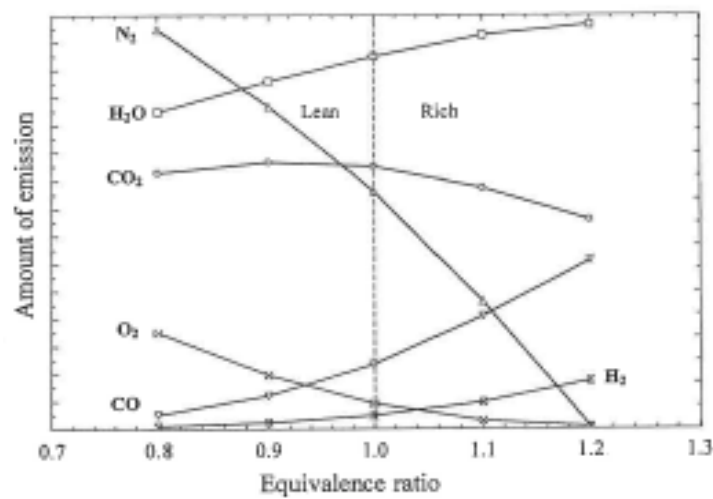


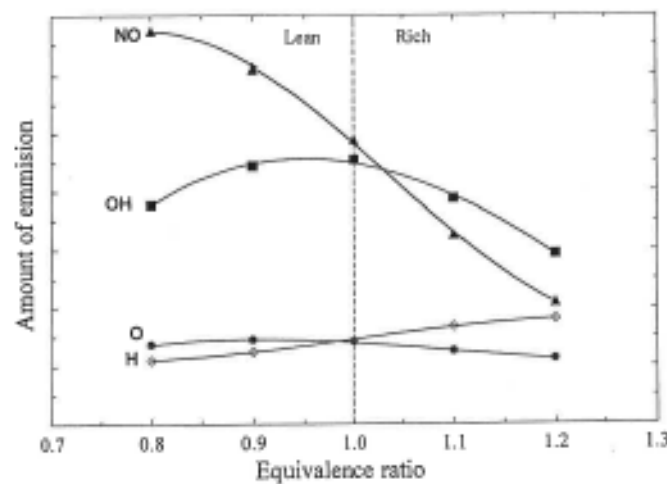
Figure 4: The maximum temperature in a spark ignition Engine as a function of equivalence ratio



**Figure 5:** The maximum pressure in a spark ignition Engine as a function of equivalence ratio

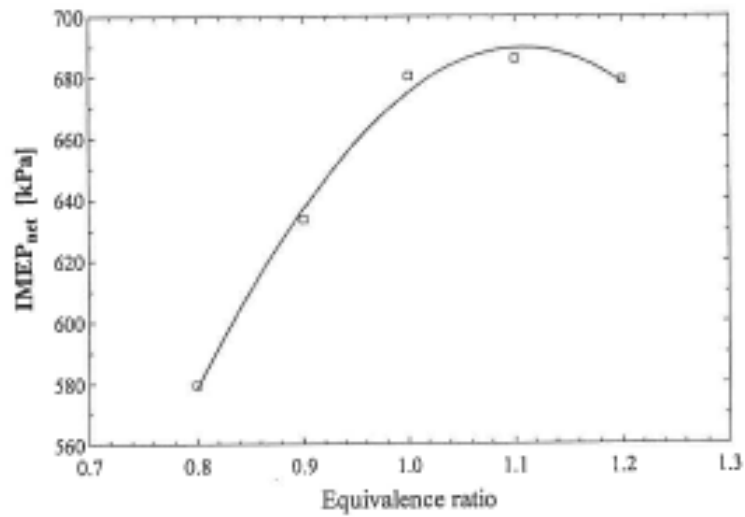


**Figure 6:** Calculated emission species from SI Engine as a function of equivalence ratio

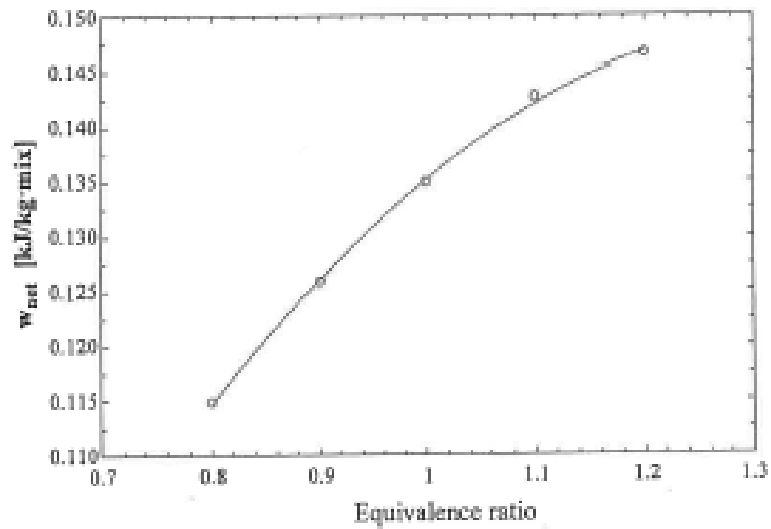


**Figure 7:** Minor species distribution of gasoline-air combustion as a function of equivalence ratio

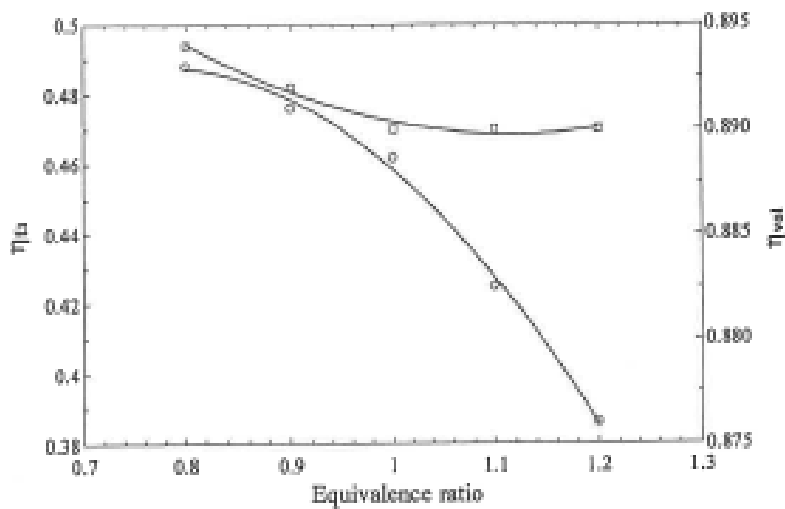




**Figure 8:** The indicated mean effective pressure in a spark ignition Engine as a function of equivalence ratio



**Figure 9:** The specific net work output in a spark ignition Engine as a function of equivalence ratio



**Figure 10:** The thermal efficiency and the volumetric efficiency in a spark ignition Engine as a function of equivalence ratio

**Table 1:** Constant coefficients for the 2nd degree polynomial fit for calculating equilibrium composition species [  $A = a_0 + a_1\Phi + a_2\Phi^2 + a_3\Phi^3$  ]

Species	$a_0$	$a_1$	$a_2$	$a_3$
CO <sub>2</sub>	-0.12518	0.48240	-0.26244	0.0000
H <sub>2</sub> O	-0.05721	0.30487	-0.11241	0.0000
N <sub>2</sub>	0.72780	0.08310	-0.09530	0.0000
O <sub>2</sub>	0.40063	-0.79427	0.49581	-0.0930
CO	0.11649	-0.32621	0.23365	0.0000
H <sub>2</sub>	-0.06062	0.23177	-0.30227	0.1361
H	0.02261	-0.07424	0.07879	-0.0263
O	-0.02875	0.08507	-0.07927	0.0238
OH	-0.09015	0.24637	-0.19534	0.0461
NO	-0.16013	0.54262	-0.55168	0.1768

### References

- [1]. J.B. Heywood. International combustion engine fundamental. McGraw-Hill, (1988).
- [2]. J. A. Alson, J. M. Adler, T. M. Baines, 1989, "Motor Vehicle Emission Characteristics and Air Quality Impacts of Methanol and Compressed Natural Gas", in Alternative Transportation Fuels — An Environmental and energy Solution, Green-Wood Press, D. Sperling, Editor.
- [3]. J. B. Heywood, Motor vehicle emissions control: past achievements, future prospects. In Handbook of Air Pollution from Internal Combustion Engines, (Ed. E. Sher, Academic Press), (1998).
- [4]. S. Hochgreb, Combustion-related emissions in SI engines. In Handbook of Air Pollution from Internal Combustion Engines, (Ed. E. Sher, Academic Press), (1998).
- [5]. J. H. Horlock, DE. Winterbone - Benson Rowland S. Thermodynamics and gas dynamics of Internal Combustion engine. New York: Clarendon Press Oxford (1986) vol. 11.
- [6]. C. R. Ferguson and A. T. Kirkpatrick. Internal combustion engines. Second Edition, John Wiley and Sons, Inc. New York (2001).
- [7]. R. Miller, G. Davis et al. A Super-Extended Zel'dovich Mechanism for NOX Modeling and Engine Calibration. SAE 980781, (1998).
- [8]. E. Sher and T. Bar-Kohany. Optimization of variable valve timing for maximizing performance of an unthrottled SI engine-a theoretical study. Energy 27 (2002) 757-775.
- [9]. Stephen R. Turns. An Introduction to Combustion. 2nd ed. Singapore: McGraw-Hill; (2000).
- [10]. R. A. Svehla and B. H. McBride (1973), "Fortran IV Computer Program for Calculation of Thermodynamic and Transport Properties of Complex Chemical Systems," NASA TND-7056.
- [11]. li jingding, Guo linsong, Du Tianshen, Formation And Restraint of Toxic Emissions in Hydrogen-Gasoline Mixture Fueled Engines. International Journal of Hydrogen Energy, 23: (10) (1998) 971-975.

Eng. Waleed K.Al Faraj. "A computational study on nonlinear curve-fitted equation for estimating gasoline –engine exhausts emissions." IOSR Journal of Mechanical and Civil Engineering (IOSR-JMCE), vol. 15, no. 6, 2018, pp. 49-58.