

Strength of CFST at Elevated Temperature

A.T.Kassem

Assistant Professor Civil Engineering Department, Faculty of engineering / Beni-suef University, Egypt
 Corresponding Author: A.T.Kassem

Abstract: This paper deals the strength behavior of concrete filled steel tubes at elevated temperature. The main purpose of such a research is to figure out the significance of various structural parameters on the strength of CFST at elevated temperature. Two separate models have been prepared. The first to deal with temperature distribution within the CFST section, when subjected to interfacial ISO 834 fire. The second to determine buckling load of the CFST using a composite frame element model, considering structural material properties, compatible with Euro-code models, based on temperature outputs resulting from the first model.

Keywords CFST, buckling, fire

Date of Submission: 03-01-2018

Date of acceptance: 18-01-2018

I. Introduction

Concrete filled steel tubes are commonly used as columns due to their perfect form, ease of construction; due to using the steel tube as both shuttering and structural element. The main concern regarding using CFST as structural elements is their low fire endurance; resulting from concentration of steel reinforcement, in the form of a tube and bars, at the outer boundary of the column. Steel vulnerability to fire loads limits such an application. This research concerns in detail the failure behavior of CFST at elevated temperatures, through studying temperature distribution within the CFST, then studying their structural failure, whether it is a yield or buckling mode.

II. Thermal-structural Modelling

The philosophy of the research was based on establishing two separate models, by which the problem was attacked. The first is a heat transfer model, by which temperature distribution within the CFST was determined as a function of time. The ISO 834 has been chosen as a fire load at the surface of the CFST. Material properties models for specific heat and thermal conductivity have been chosen compatible with the EURO code. Figure (1) represents the thermal model, used in determining temperature distribution within the CFST.

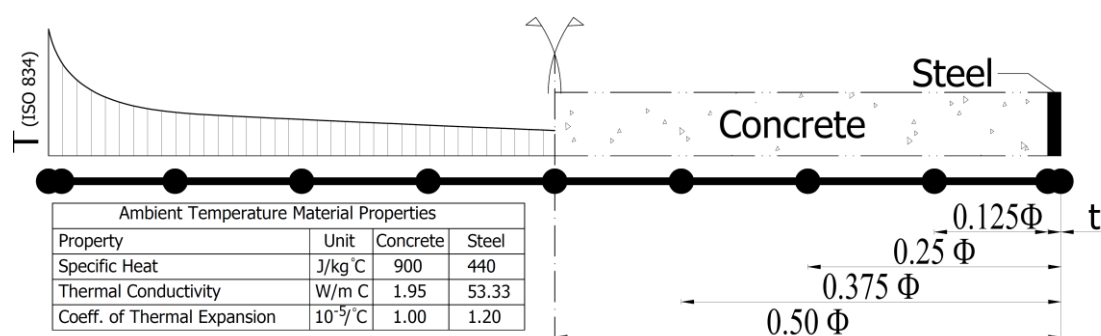

Figure (1) CFST Thermal Model

After extracting temperature distribution curves from the thermal model as shown in figures (2) up to (9), another model has been prepared for the structural analysis.

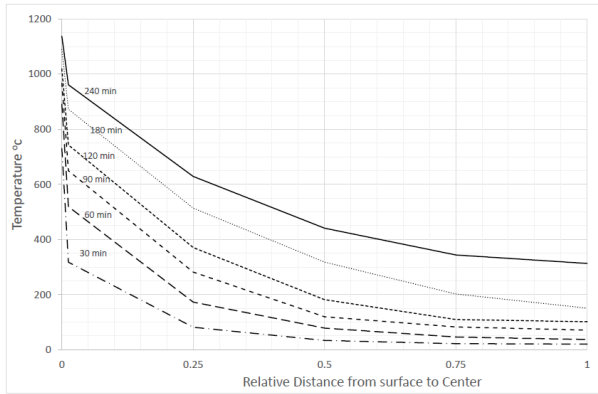

Fig. (2) Φ 400 mm CFST Temp. Distribution

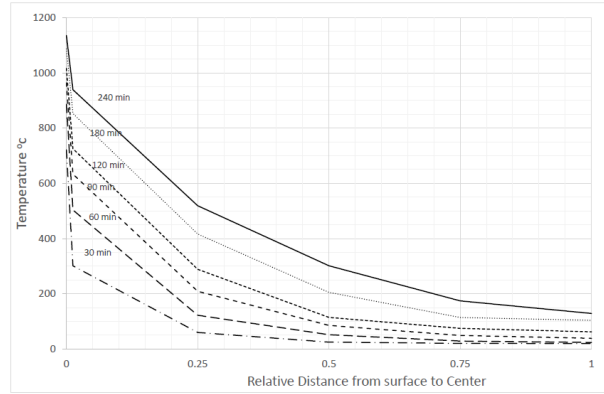

Fig. (3) Φ 500 mm CFST Temp. Distribution

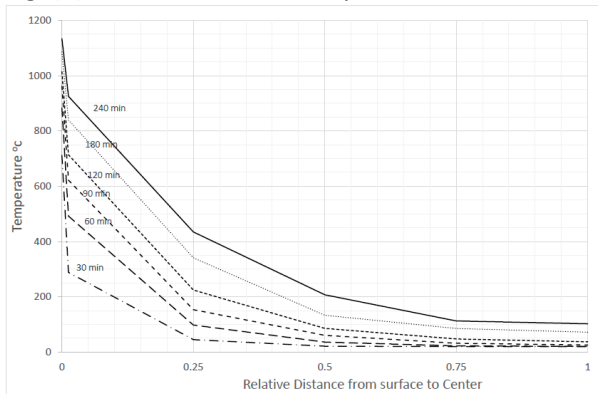

Fig. (4) Φ 600 mm CFST Temp. Distribution

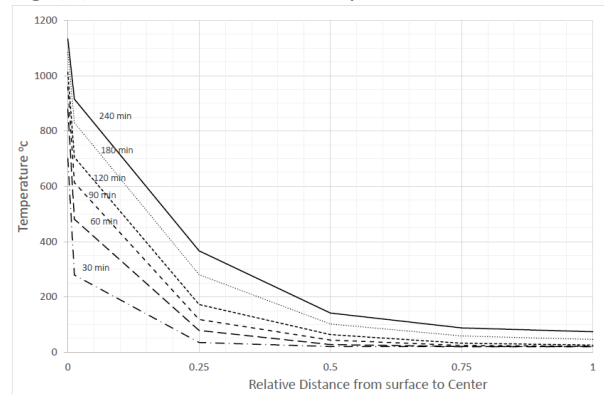

Fig. (5) Φ 700 mm CFST Temp. Distribution

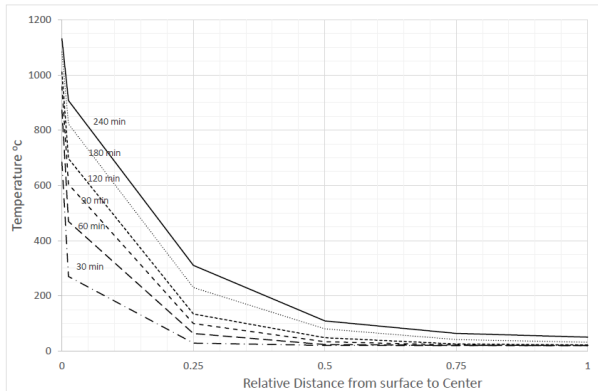

Fig. (6) Φ 800 mm CFST Temp. Distribution

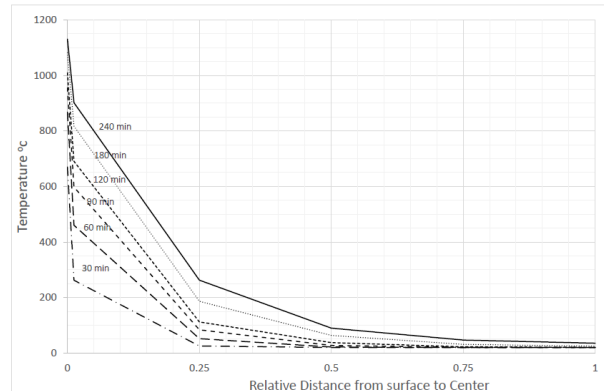

Fig. (7) Φ 900 mm CFST Temp. Distribution

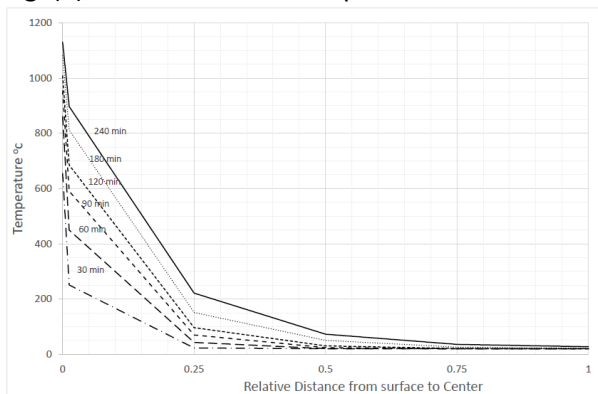

Fig. (8) Φ 1000 mm CFST Temp. Distribution

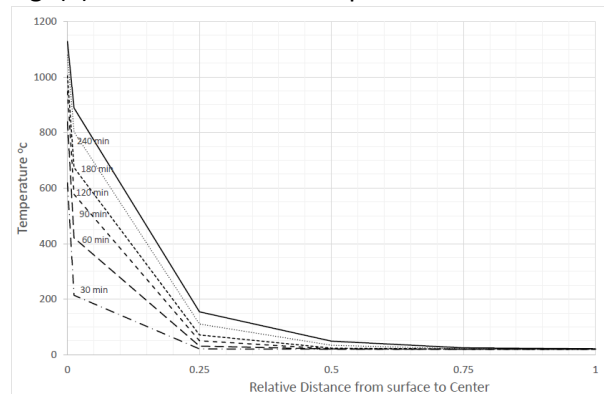

Fig. (9) Φ 1200 mm CFST Temp. Distribution

The second model concerned the buckling behavior of the CFST. Composite frame element has been chosen to model CFST buckling behavior. Multi-layered element structure has been chosen to model the

variation in material properties throughout the section. EURO code models for structural material properties degradation have been adopted. Material properties at each step per layer have been considered based on thermal model temperature distribution within the section, in conjunction with EURO code strengths and moduli of elasticity models. Figure (10) shows a cross-section of the multi-layered frame element used to model CFST.

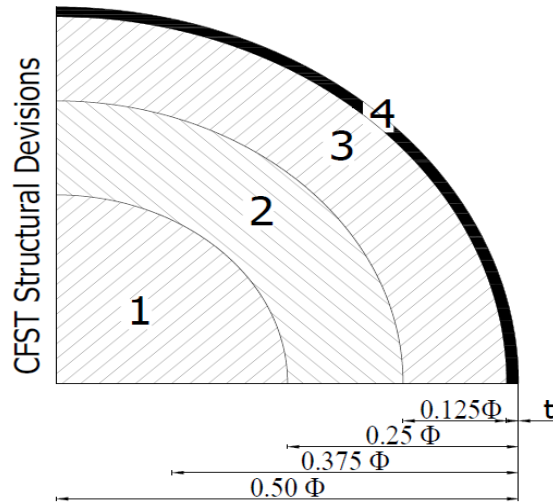
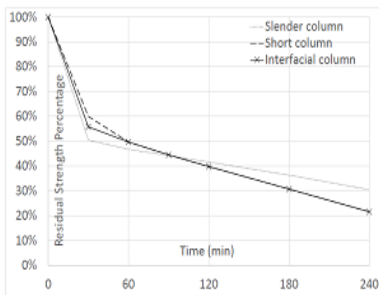

Figure (10) CFST Multi-layered Model

III. Parametric Study

It was essential, once the model has been established to run a parametric study; to figure out the significance of various structural parameters on the strength of CFST at elevated temperatures. Concrete characteristic strengths of 25, 50, and 75 MPa have been considered as a structural parameter; to cover the practical spectrum of concrete strength. Column's diameter ranging from 400 up to 1200 mm has been considered. Three slenderness ratios have been considered to study the behavior of short, intermediate, and slender columns respectively. The last parameter was the application time of fire load, which ranged from zero up to four hours. Figures (11) up to (34) represent the fall –down of load ratio, as a function of time, for various slenderness ratios. While figures (35) up to (52) represents that fall-down as a function of column diameter, for various slenderness ratios.



Fig(11) 400mm CFST strength (fc 25MPa)

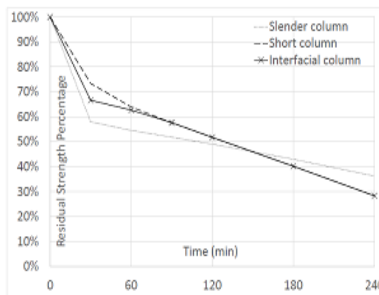

Fig(12) 400mm CFST strength (fc 50MPa)

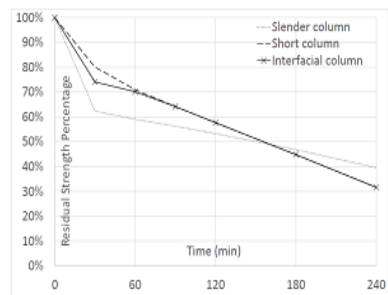

Fig(13) 400mm CFST strength (fc 75MPa)

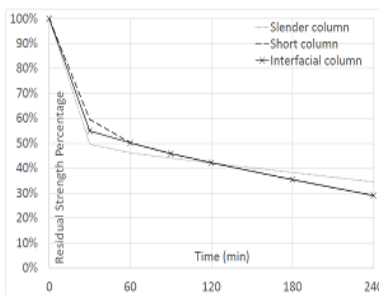

Fig(14) 500mm CFST strength (fc 25MPa)

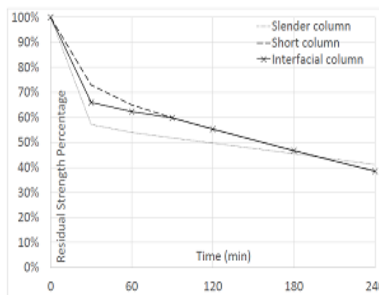

Fig(15) 500mm CFST strength (fc 50MPa)

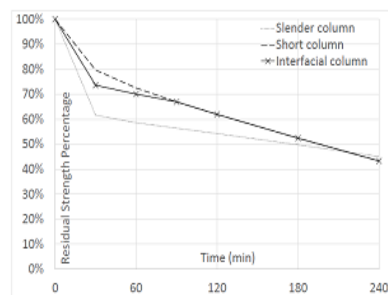

Fig(16) 500mm CFST strength (fc 75MPa)

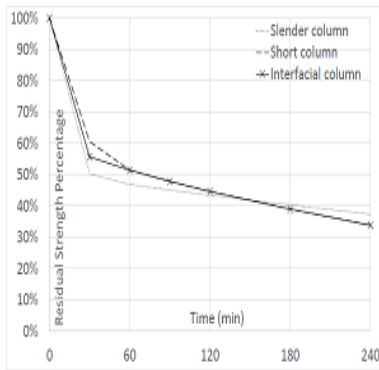

Fig.(17) $\phi 600$ mm CFST strength (f_c 25MPa)

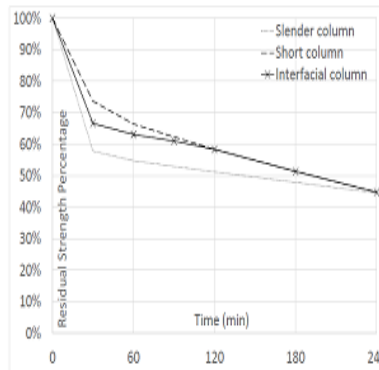

Fig.(18) $\phi 600$ mm CFST strength (f_c 50MPa)

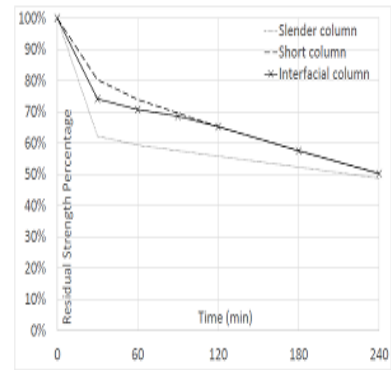

Fig.(19) $\phi 600$ mm CFST strength (f_c 75MPa)

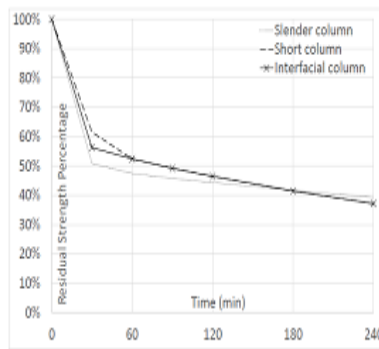

Fig.(20) $\phi 700$ mm CFST strength (f_c 25MPa)

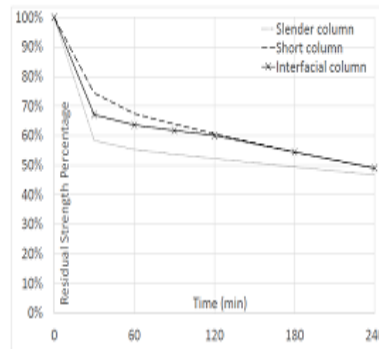

Fig.(21) $\phi 700$ mm CFST strength (f_c 50MPa)

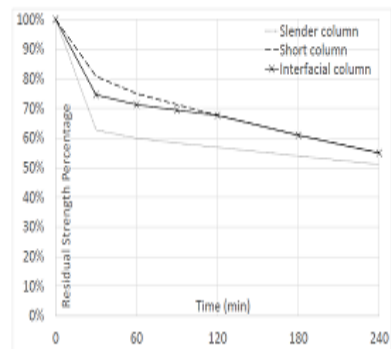

Fig.(22) $\phi 700$ mm CFST strength (f_c 75MPa)

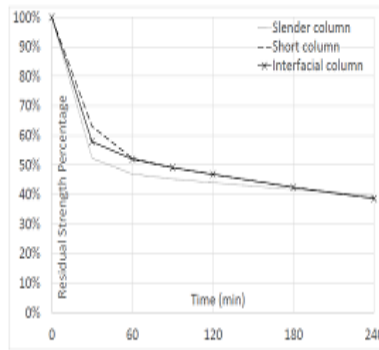

Fig.(23) $\phi 800$ mm CFST strength (f_c 25MPa)

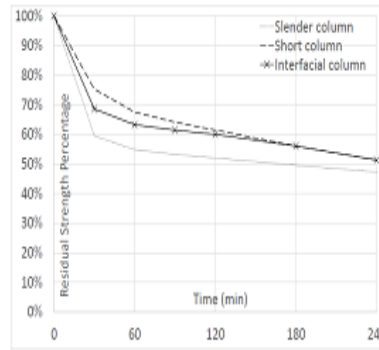

Fig.(24) $\phi 800$ mm CFST strength (f_c 50MPa)

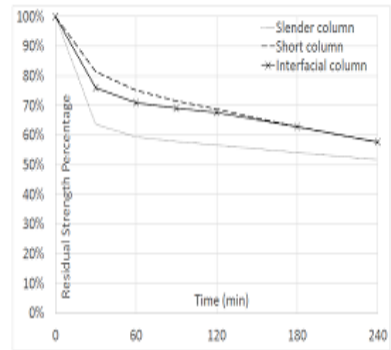

Fig.(25) $\phi 800$ mm CFST strength (f_c 75MPa)

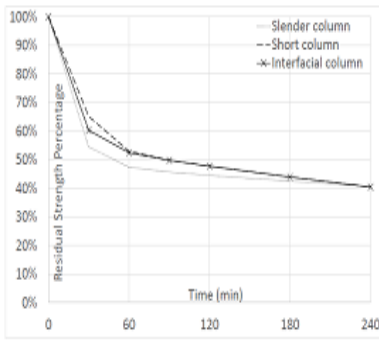

Fig.(26) $\phi 900$ mm CFST strength (f_c 25MPa)

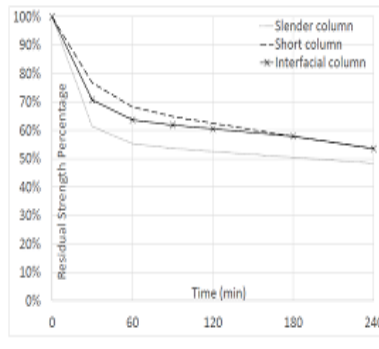

Fig.(27) $\phi 900$ mm CFST strength (f_c 50MPa)

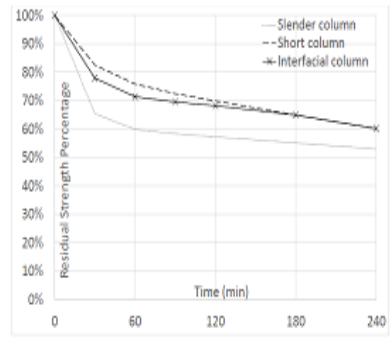

Fig.(28) $\phi 900$ mm CFST strength (f_c 75MPa)

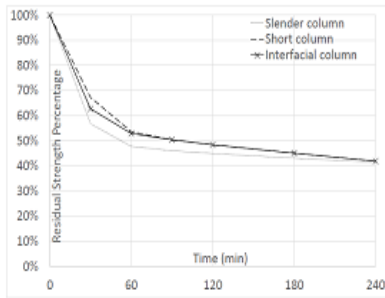

Fig.(29) ϕ 1000mm CFST strength (fc 25MPa)

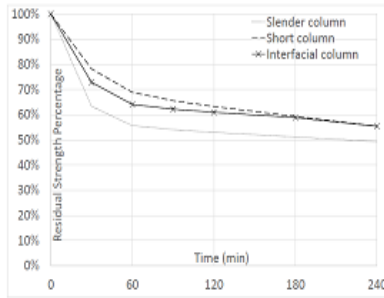

Fig.(30) ϕ 1000 mm CFST strength (fc 50MPa)

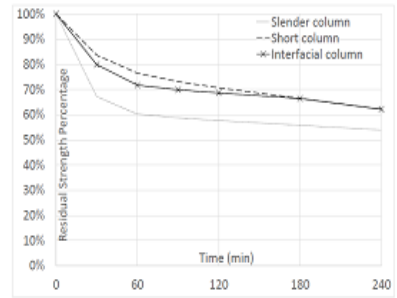

Fig.(31) ϕ 1000 mm CFST strength (fc 75MPa)

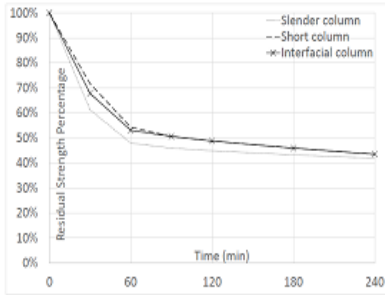

Fig.(32) ϕ 1200 mm CFST strength (fc 25MPa)

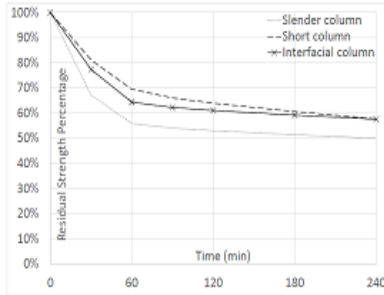

Fig.(33) ϕ 1200 mm CFST strength (fc 50MPa)

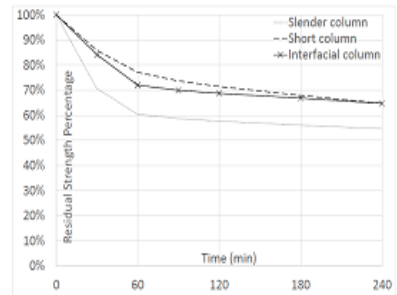

Fig.(34) ϕ 1200 mm CFST strength (fc 75MPa)

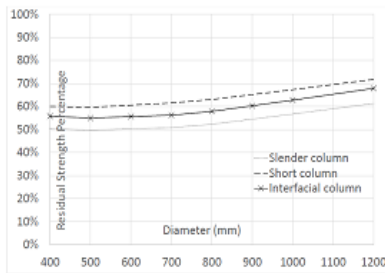

Fig.(35) CFST strength at 30 min (fc 25MPa)

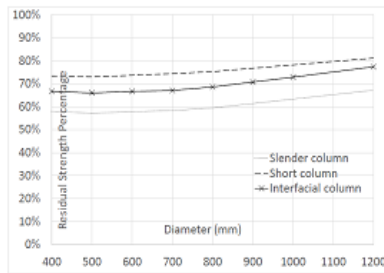

Fig.(36) CFST strength at 30 min (fc 50MPa)

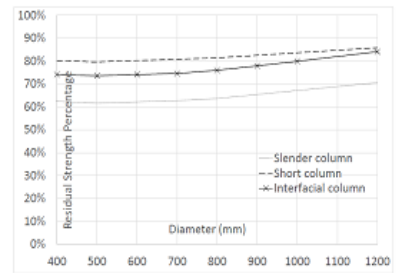

Fig.(37) CFST strength at 30 min (fc 75MPa)

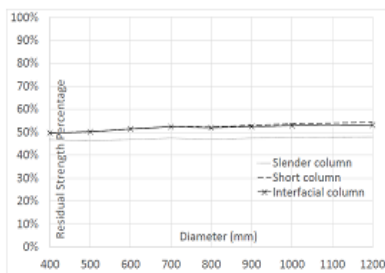

Fig.(38) CFST strength at 60 min (fc 25MPa)

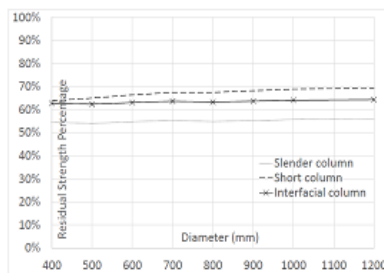

Fig.(39) CFST strength at 60 min (fc 50MPa)

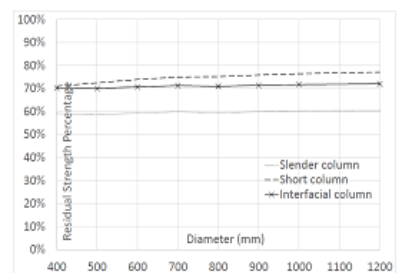

Fig.(40) CFST strength at 60 min (fc 75MPa)

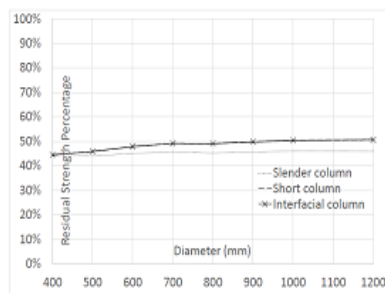

Fig.(41) CFST strength at 90 min (fc 25MPa)

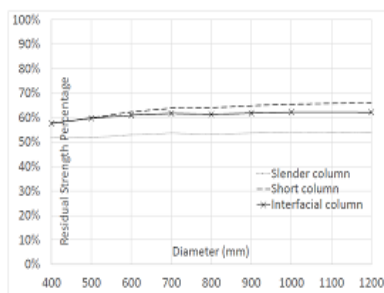

Fig.(42) CFST strength at 90 min (fc 50MPa)

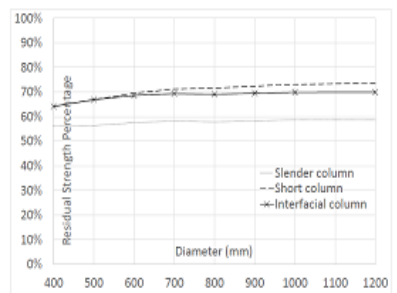

Fig.(43) CFST strength at 90 min (fc 75MPa)

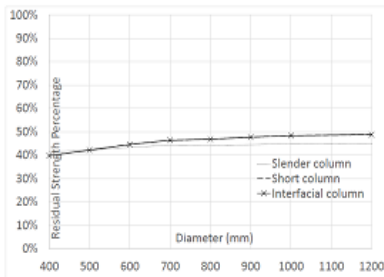

Fig.(44) CFST strength at 120 min (f_c 25MPa)

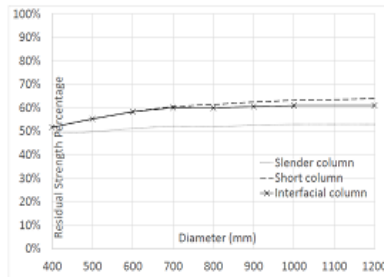

Fig.(45) CFST strength at 120 min (f_c 50MPa)

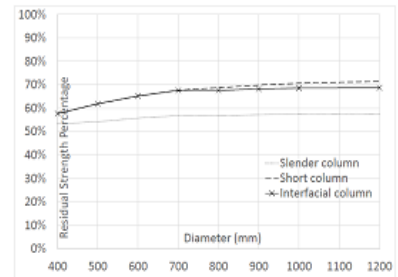

Fig.(46) CFST strength at 120 min (f_c 75MPa)

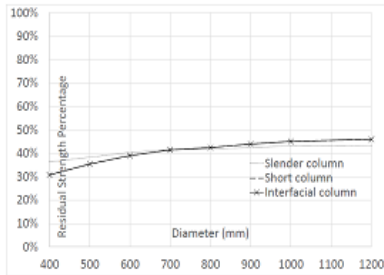

Fig.(47) CFST strength at 180 min (f_c 25MPa)

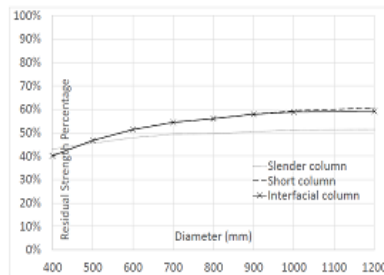

Fig.(48) CFST strength at 180 min (f_c 50MPa)

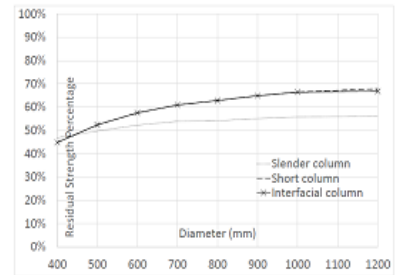

Fig.(49) CFST strength at 180 min (f_c 75MPa)

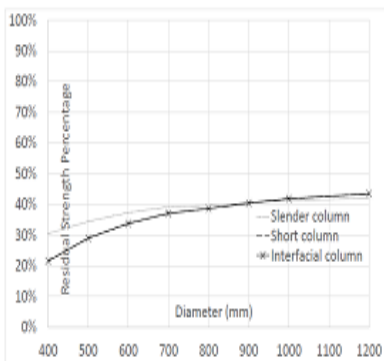

Fig.(50) CFST strength at 240 min (f_c 25MPa)

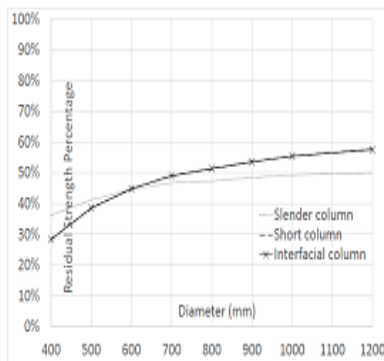

Fig.(51) CFST strength at 240 min (f_c 50MPa)

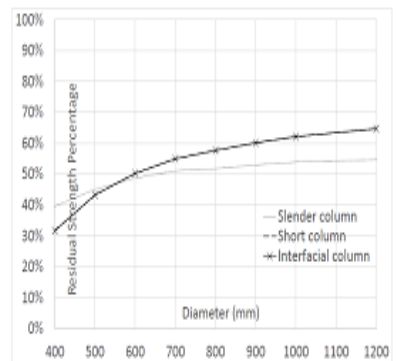

Fig.(52) CFST strength at 240 min (f_c 75MPa)

IV. Conclusions

Studying outputs of the parametric study, resulted in the following conclusions.

- 1- Strength degradation, as a function of time, is about to be bi-linear
- 2- Crushing and buckling residual strength converge by time.
- 3- The more the concrete characteristic strength, the less the degradation in CFST strength.
- 4- Increase in residual strength is about to be linear, especially for diameters exceeding 700mm.
- 5- Short columns always retain more residual strength than slender ones

References

- [1]. Aashish Y. Soni*, R.V.R.K Prasad, "Analysis & Design Of Fire Damage Structure", International Journal of Engineering Research & Technology (IJERT), Vol. 2 Issue 7, July - 2013
- [2]. J.Ramaniahl K.Jagan Mahon Rao, "Buckling Analysis of Orthotropic Composite Shell with and Without Cutouts Using Fem", International Journal of Engineering Research & Technology (IJERT), Vol. 2 Issue 8, August 2013
- [3]. Ghannam M., Tao Z., and Uy B. (2012), "Heat transfer analysis of concrete filled stainless steel columns exposed to fire", *Proceedings of the 10th, International Conference on Advances in Steel Concrete Composite and Hybrid Structures*, Singapore. 2012; pp. 873–880.
- [4]. Tao Z., and Ghannam M. (2012), "Refined FE model to predict the temperature field within concrete-filled steel tubes", *Proceedings of the 7th International Conference on Advances in Steel Structures*, Nanjing, China. 2012; pp. 781–789.
- [5]. Ghannam M., Tao Z., and Song T.Y., "Fire resistance tests of concrete filled stainless steel tubular columns", *Proceedings of the Composite Construction VII Conference*, Queensland, Australia. 2013.
- [6]. Aribert, J. M., Renaud, C., and Zhao, B., "Simplified fire design for composite hollow-section columns." *Proceedings of the ICE - Structures and Buildings*, (2008) 325-336

- [7]. Chen, J., Young, B., and Uy, B. (2006). "Behavior of high strength structural steel at elevated temperatures." *Journal of Structural Engineering*, 132(12), 1948-1954.
- [8]. Cheng, F., Kodur, V., and Wang, T. (2004). "Stress-strain curves for high strength concrete at elevated temperatures." *Journal of Materials in Civil Engineering*, 16(1), 84-90.
- [9]. Ding, J., and Wang, Y. C. (2008). "Realistic modelling of thermal and structural behaviour of unprotected concrete filled tubular columns in fire." *Journal of Constructional Steel Research*, 64(10), 1086-1102
- [10]. Han, L.-H., Chen, F., Liao, F.-Y., Tao, Z., and Uy, B. (2013). "Fire performance of concrete filled stainless steel tubular columns." *Engineering Structures*, 56, 165-181.
- [11]. Kodur, V., and Khaliq, W. (2011). "Effect of temperature on thermal properties of different types of high-strength concrete." *Journal of Materials in Civil Engineering*, 23(6), 793-801
- [12]. Ataman HAKSEVER, "A Practical Method For The Calculation Of Fire Resistance Of Reinforced Concrete Columns", *Trakya University Journal of Engineering Sciences*, 14(2): 115-126, 2013
- [13]. Kai Xiang, Guo-hui Wang, "Experimental Study on Temperature Distribution of Concrete Filled Steel Tube Reinforced Concrete Square Short Columns", Elsevier Ltd. Open access under CC BY-NC-ND license. Peer-review under responsibility of School of Engineering of Sun Yat-Sun University
- [14]. Joao Paulo Rodrigues, Luis Laim, Manfred Korzen, "Fire behavior of Circular Concrete Columns with Restrained Thermal Elongation", *Journal of Advanced concrete technology*, vol 12, (2014), pp (289-298).
- [15]. José Carlos L. Ribeiro, Ricardo H. Fakury, Estevam B. de Las Casas, "Euro code Structural Fire Design and its Application for Composite Circular Hollow Section Columns" The tabular structural fire design method for centrally loaded, ABCM January-March 2008, Vol. 1
- [16]. Euro code 2 Part 1-2 –October 2001, "Design of Concrete Structures-Part 1-2: General rules-Structural fire design".

A.T.Kassem "Strength of CFST at Elevated Temperature." *IOSR Journal of Mechanical and Civil Engineering (IOSR-JMCE)* , vol. 15, no. 1, 2018, pp. 41-47