

## “Impact of Aluminum Alloys and Microstructures on Engineering Properties - Review”

Ankitkumar K. Shriwas<sup>1</sup>, Vidyadhar C. Kale<sup>2</sup>

<sup>1</sup>(Pg student, GESSRH Sapat COEM studies and research, Nashik, India)

<sup>2</sup>(Guide, GESSRH Sapat COEM studies and research, Nashik, India)

**Abstract:** From post twentieth century use of aluminium alloys increases drastically in automobile and aerospace industries. The aluminium alloy takes the advantage of ‘strength to weight ratio’ and corrosion properties over other structural element such as steel and its alloys. The altered mechanical properties are achieved in aluminium alloy by using different strengthening techniques such as age hardening etc. The favourable mechanical properties are explained by revealing the microstructure of corresponding alloy and intermediate phase compounds during formation of corresponding alloy. Hence study of microstructure and their impact on mechanical properties is essential. In the present review paper the microstructure of aluminium alloys series are explained and their emphasis on the mechanical properties are discussed. By doing so, the research gap and the flow of research fields are exposed for further development

**Keywords:** Aluminium alloy series, Microstructures, Mechanical properties, Intermediate compounds

### I. Introduction

The aluminium is light, ductile and third most abundant element in the earth crust. It has poor mechanical properties such as yield strength 7 to 11 MPa, ultimate tensile strength 40 to 50 MPa. Hence pure aluminium cannot be used in the automobile and aerospace industry where their strength is examined. Later on the industries uses steel and its alloy for construction of parts. No doubt steel and its alloy has good strength but it also puts large weight as density of steel is three times that of aluminium. In mid twentieth century the use of aluminium alloy is enhanced. As they provide greater or equal strength to weight ratio as that of the steel and also it is lighter than them. There are numerous advantages of aluminium alloys over other design material like good corrosion resistances, high strength to weight ratio, good formability, good machinability and scarp reuse etc. Hence automobile and aerospace industries put a lot of attention toward aluminium alloy instead of heavy steel structure [6]. Basic element composition in the aluminium alloy series is given below,

**Table 1** Aluminium Alloy Series Composition

Series	Cast aluminium alloy composition	Wrought aluminium alloy composition
1	Al	Al
2	Al+Cu	Al+Cu
3	Al+Si+Cu/Mg	Al+Mn
4	Al+Si	Al+Si
5	Al+Mg	Al+Mg
6	Al+Zn	Al+Mg+Si
7	Al+Mg+Zn	Al+Mg+Zn
8	Al+Sn	Al+Li/Sn/B

Due to differential composition in the series the alloys of each series shows different microstructure, so their mechanical properties and behaviour is also different. Now we analyse the microstructure of major aluminium alloy series and their influence on mechanical properties.

### II. Microstructure and their impact on mechanical properties

#### 2.1 2XXX series (Al+Cu)

The 2XXX series aluminium alloy mainly contains copper as a alloying element, sometimes for better strength, corrosion resistance and grain structure control along with copper small amount of magnesium, manganese, iron or silicon is added. When copper is primarily added following intermetallic phases are seen, Super saturated solid solution  $\rightarrow$  GP zones  $\rightarrow$   $\theta'$   $\rightarrow$   $\theta$   $\rightarrow$   $\theta''$

These intermediate phases are formed during ageing. Phase diagram is shown for typical Al-Cu alloy [2].

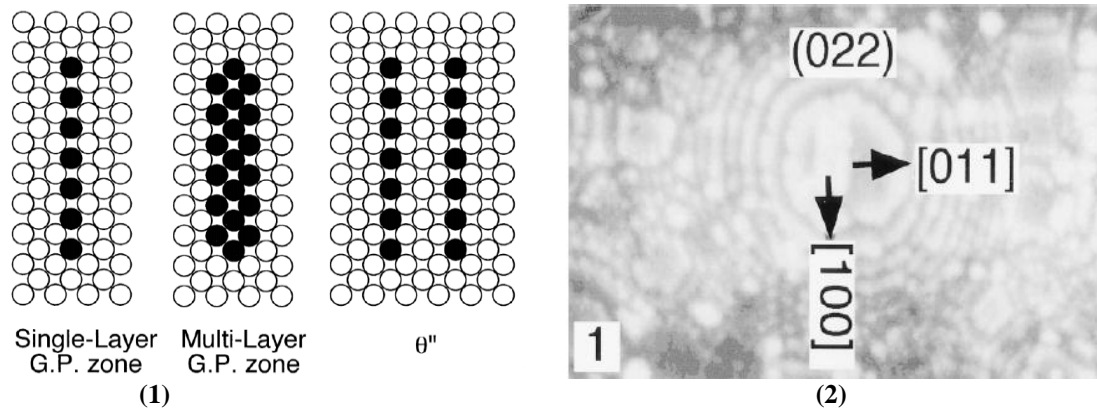

**Figure 1:** (1) Structure of GP zones and  $\theta''$  in alloy. (2) Field ion micrograph of Al-Cu alloy.

GP zone (Guiner Preston) is harder, has thickness about 5-10 nm. Initially single layered GP zone is formed then multilayered.  $\theta''$  is metastable intermediate compound which are placed apart. As ageing continues  $\theta'$  is formed from  $\theta''$  but hardness slightly decreases. And if prolonged ageing is done then  $\theta$  phase (equilibrium phase) is formed (hardness further decreases) [19].

1. GP zone : single or multilayered, deposits on  $\{100\}$  planes of Al, non equilibrium, coherent, it has disc planer shape, plane of deposition may changes as thermodynamic situations get changes in Al matrix.
2. GP II/  $\theta''$  : two layer of Cu separated by  $\{011\}_\alpha$  layer of Al, rod like shape , coherent, non equilibrium.
3.  $\theta'$  : body centred tetragonal (I4/mcm,  $a=0.404$  nm,  $c=0.580$  nm) shape, coherent, non equilibrium, sometimes octagonal shape is also seen  $\{001\}_\alpha // \{001\}_{\theta'}$ ,  $\{010\}_\alpha // \{010\}_{\theta'}$ .
4.  $\theta$  : equilibrium phase, non coherent  $\text{Al}_2\text{Cu}$ . Tetragonal (I4/mcm,  $a=0.6066$  nm,  $c=0.4874$  nm) occur variety of orientation and morphologies [2].

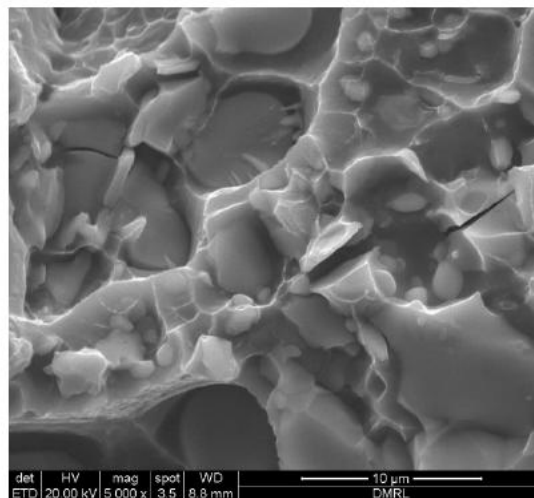

**Figure 2:** Fractograph for mechanism of failure.

During working the fatigue crack resistance of 2XXX series aluminium alloy can be increased by shot peening method. It reduces averages size of grains, reduces crack growth by inducing compressive stresses [13]. For reducing grain size ECA (equal channel angular) pressing is done for both 2XXX and 1XXX alloy [16]. In 2010 influence of heat treatment on fatigue behaviour of Al 2024 and 2024 plated is studied, which claims that about 34% fatigue resistance is enhanced after ageing [6]. In 2014, tensile deformation and fracture behaviour of 2XXX Al alloy is studied, which shows that hardness, tensile strength, fracture toughness is increased from low age to peak age condition. As ageing changes microstructure changes, the intermetallic compound is also changes ultimately mechanical properties get changes [6]. Latest studies show GP zone has 100-150 A diameter disc shape,  $\theta''$  is also plate but 200-500 A in diameter [6]. A case is studied for defects in 2XXX series Al alloy in 2012, by two dimensional 17D doppler broadening spectroscopy. They show after HPT (high pressure torsion) on Al-3%Cu gives fine grain microstructure. Dominant trapping occur at deformation induced dislocations and grain boundaries. Copper related defects are strongly reduced after deformation [7].

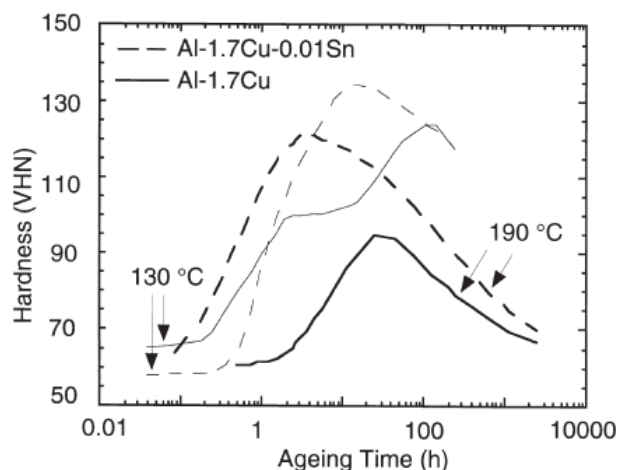
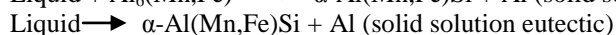

**Figure 3:** Graph of hardness vs aging time for 2XXX alloys.

Today along with copper some trace element such as silver, titanium and chromium is added to get desired result from that alloy. There are more channels for research toward composite using Al-Cu alloy which changes microstructure of them and generates new mechanical properties.

### 2.2 3XXX series aluminium alloys

3XXX series aluminium alloy contains manganese as prime element, after that in trace amount iron, silicon and zinc is also added. The iron is mainly used to refine the grain and coarse intermetallic particles. The phase transformation is as,



During solidification of Al-Mg-Si alloys most intermetallic compounds of Al-Mn-Si are formed by peritectic transformation. The precipitation is not easy and its location is also tentative. It is found that, by many researchers  $\alpha\text{-AlMnSi}$  has cubic structure ( $a_0 = 1.2670 \text{ nm}$ ) and has microstructural composition as  $\text{Mn}_{17}\text{Si}_7\text{Al}_5$ . The  $\alpha\text{-AlMnSi}$ , cubic structure becomes body centered cubic that is  $\alpha\text{-Al}(\text{Fe,Mn})\text{Si}$  having composition as  $(\alpha\text{-Al}_{12}(\text{Mn,Fe})_3\text{Si})$  as Fe content increases. It is found by researcher that 90% of Mn in 3XXX series aluminium alloy is replaced by slight addition of Fe. One more research is done that after casting the  $\text{Al}_6(\text{Fe,Mn})$  is changed to  $\text{Al}_{12}(\text{Mn,Fe})_3\text{Si}$  and on annealing to Al-Mn-Fe-Si complex alloy [13].

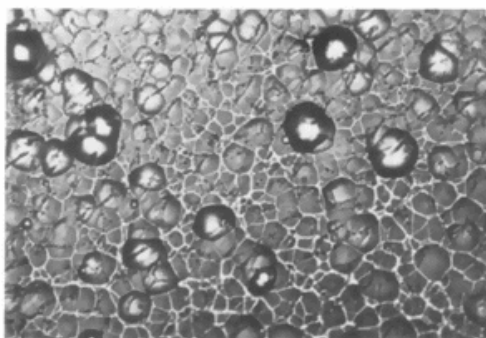

**Figure 4:** Microstructure of Al-Mn alloy in chill cast condition.

The presence of iron reduces the solid solubility of Mn from 1.9% to 0.3% hence sometimes due to high concentration of Fe in 3XXX alloy the intermetallic compound contains very less amount of Mn. The size of grain is about  $0.5 \mu\text{m}$  and interparticle spacing is approximately  $4 \mu\text{m}$ . When 3XXX series aluminium alloy is heated at  $740^\circ\text{C}$  and casted with cooling temperature  $550^\circ\text{C}$  shows  $\text{Al}_6\text{Mn}$  phase in their microstructure on the other hand when the alloy is heated about  $800^\circ\text{C}$  and cooled at  $550$  to  $500^\circ\text{C}$   $\text{Al}_6\text{Mn}$ ,  $\alpha\text{-AlMnSi}$  and  $\text{AlMn}_{8,4}$  intermetallic compounds are seen. Some compounds are detected when 3XXX alloy is heated at  $700^\circ\text{C}$  and solidified at  $600, 500, 450$  and  $400^\circ\text{C}$ . When 0.5% of Fe 3XXX alloy is selected and chill cast the microstructure mainly contains  $\text{Al}_6\text{Mn}$ ,  $\text{AlMn}_{8,4}$  and  $\text{Al}_9\text{Mn}_3\text{Si}$  intermediate compound [13]. I.A.Blech found same results and gives the structure of  $\text{Al}_6\text{Mn}$  as elongated branches that stem from centre core [6].  $\text{Al}_6\text{Mn}$  has isohedral shape and about  $0.2 \mu\text{m}$  in size. When annealed at 26 hr at  $350^\circ\text{C}$  this isohedral shape is stable. The author is also claims that Al-18%Mn consist of two phases in aluminium matrix, one has small dispersed particles about  $10 \text{ nm}$  and

second spherulitic in shape which about 0.3  $\mu\text{m}$  in diameter. Circumference is round, petal like edge about 60 nm in diameter. It occupies 36% of the volume [6].

The 3XXX alloy generally contains Mn with minor quantity of Fe and Si. The high Mn contains increases castability and machinability of alloy. The more research is needed about the nature of intermediate compounds which prominently affects the mechanical properties. The research should be done over the study of intermediate compounds of 3XXX aluminium alloys.

### 2.3 4XXX aluminium alloys (Al+Si)

In 4XXX series aluminium alloy main constitute is Si and in small amount Fe as impurity is also present. The % of Fe may be higher or lower depending upon that low Fe, moderate Fe and high Fe contained 4XXX series aluminium alloy is classified. During chill casting of 4XXX Al alloy main intermetallic compound are  $\alpha\text{-Al}_8\text{Fe}_2\text{Si}$  phase and  $\beta\text{-Al}_5\text{FeSi}$  phase ( $\text{Al}_{4.5}\text{FeSi}$ ). They have structure hexagonal and monoclinic respectively. But when Mg and Mn is added then microstructure shows T- $\text{Al}_8\text{FeMg}_3\text{Si}_6$  ( $\text{Al}_9\text{FeMgSi}_5$ ) and cubic  $\text{Al}_{15}(\text{Fe},\text{Mn})_3\text{Si}_2$ . The cubic  $\text{Al}_{15}(\text{Fe},\text{Mn})_3\text{Si}_2$  shows compact blocky form polyhedral crystal on the other hand  $\Pi$  phase is script like morphology. The  $\Pi$  phase is generated from  $\beta$  phase after different solidification rates.  $\beta$  phase is  $\text{Al}_5\text{FeSi}$  which has plate like shape. It is found by researchers that as cooling rate is slow the iron containing intermediate particles has size 50-500  $\mu\text{m}$  but when cooling rate is high the grain size is 10-50  $\mu\text{m}$ . The size of intermetallic compound increases as the Fe contains increases. This also causes decreases in ductility. The increased contain of the Fe increase the porosity and casting defects [9]. In 2014, K. Raju and S.N.Ojha shows the grain structures are small during spray forming. Also wear and hardness properties are good. The Si contain intermetallic compound has size 2-10  $\mu\text{m}$ , and coarser nature [17]. During the chill cast of Al-Si alloy, silicon needles are formed. They have length 20-150  $\mu\text{m}$ . When Si is 20% weight in Al then in chill casting, eutectic Si (20-50  $\mu\text{m}$ ) and primary Si (30-150  $\mu\text{m}$ ) are formed [17]. Same in 2014, R.Saravana and R.Sellamuthu gives same result that grains are refined and mechanical properties are improved [11]. The research should be done on the effect of concentration of intermediate compound of different impurities such as Cr, Mn etc.

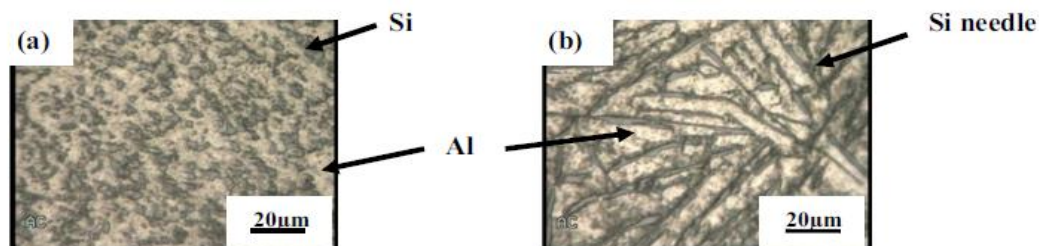

**Figure 5:** (a) Spray formed Al-12Si (b) Chill cast Al-12Si

### 2.4 5XXX series aluminium alloy (Al+Mg)

The main alloying element in this series is magnesium (Mg). Proper addition of Mg in Al gives the alloy moderate to high strength to work hardenable characteristics, good welding characteristics and good resistance to corrosion. When proper heat treatment and cold working is done then Mg particles precipitates in large amount at grain boundaries. As cold working increases, the amount of precipitates also increases. When the 5XXX series aluminium alloy is formed intermetallic phases are  $\text{Al}_3\text{Mg}_2$  and  $\text{Al}_{12}\text{Mg}_{17}$ . The microstructure gets change when small amount of Si is added in the alloy. In that case  $\text{AlMgSi}$  complex are formed.  $\text{Al}_3\text{Mg}_2$  and  $\text{Al}_{12}\text{Mg}_{17}$  plays important role in the fracture behaviour [17]. These phases improve the mechanical properties. The next two series also contains Mg, hence more complex intermediate compounds are formed in those alloys. More research is needed about grain structure of  $\text{Al}_3\text{Mg}_2$  and other intermediate particles. There is wide research gap for pure Al-Mg alloy with very less impurities about mechanical properties and precipitations. Often today last two series alloys are widely used because they also contain Mg. Following are some 5XXX series aluminium alloys, for which intermetallic compounds are given,

**Table 2** Designations And Structures of Intermetallic Compounds

Intermetallic compound	Designations	Structure
$\text{Mg}_2\text{Si}$	$\beta$ phase	FCC
$\text{Mg}_2\text{Al}_3$	$\beta$ phase	FCC
$\text{CuMgAl}_2$	S phase	FCC / orthogonal
$\text{CuMgAl}$	U or M phase	Hexagonal
$\text{CuMg}_4\text{Al}_6$	T phase	BCC
$\text{CuMg}_6\text{Al}_7$	Q or Y phase	Cubic
$\text{Cu}_6\text{Mg}_2\text{Al}_5$	V or Z phase	Cubic
$\text{Cu}_2\text{Mg}_8\text{Si}_6\text{Al}_5$	-	Hexagonal

### 2.5 6XXX series aluminium alloy (Al+Mg+Si)

The 6XXX aluminium alloy is age hardenable contains mainly Si and Mg. For making different alloy in this series Fe, Cr or Mn is also added so that intermediate compounds get changed. The only 6XXX series aluminium alloys are there in which fine scale precipitation compounds has been found. The precipitation sequence is,

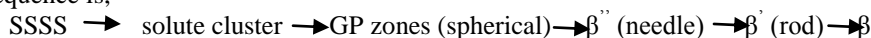

Where SSSS stands for supersaturated solid solution,  $\beta$  is equilibrium phase  $Mg_2Si$ , while  $\beta''$  and  $\beta'$  are intermediate phases which provides highest hardness and good mechanical properties [2]. It is found that ratio for Mg and Si is 1:1 for  $\beta$ ,  $\beta''$  and GP zones. But amount of precipitation of Al- $Mg_2Si$  is dependent over other alloying elements also. The  $\beta''$  phase is formed during ageing in cluster form. The location for  $\beta''$  precipitates are provided by GP zones which are formed during pre ageing of alloy. Sometimes Cu is also present in the 6XXX series aluminium alloys, the microstructural compounds are also different. Basically Q' and Q phase ( $Cu_2Mg_8Si_6Al_5$ ) are formed but they do not gives any hardening effect to alloy [2]. Due to these intermetallic compounds these alloys are used for automobile body sheets applications. They acquire good weldability, corrosion resistance, formability and medium strength etc [2]. In 2013, H.Q.Wang and their partners gives microstructure of 6061 aluminium alloy after casting and diffuse annealing process. It is found that main strengthening phase is  $Mg_2Si$ . A new phase is also found that is  $(Fe,Mn)_3Si_2Al_{15}$  as alloy contains small amount of Fe and Mn. The researchers also show that when Mg to Si ratio is 1.73, main strengthening phase is  $Mg_2Si$  and all copper melted in the base. When ratio is 1.08 then  $\omega$  phase ( $Al_4CuMg_5Si_4$ ) is seen and when ratio is beyond 1.73 then  $\theta$  phase ( $Al_2Cu$ ) and S phase ( $Al_2CuMg$ ) are seen in microstructure. These intermediate compound also provide strengthening effect but less than that of  $Mg_2Si$ . It is found out by researchers  $Mg_2Si$  has bone like shape and appear light blue before erosion.  $(Fe,Mn)_3Si_2Al_{15}$  has needle shape and light metal gray before erosion. If Fe contain is increased and Si and Mg is reduced then main compound is FeMnSiAl and  $Mg_2Si$  is melted in base. Other compound also contains Fe rich phases. The diffusion annealing eliminates grain segregation and precipitates the intermediate compounds at grain boundaries. The forging defects are minimised after diffusion annealing process and mechanical properties are also improved [13]. In 2014, K.T.Akhil and his co-workers explain that section size, cooling rate and mechanical properties are interdependent. For cast components, cooling rate and mechanical properties increases with decrease in component section size [17]. In same 2014, S.Dutta and M.S.Kaiser implement Al356 (Al-7Si-0.3Mg) alloy for piston formation. They also said that  $Mg_2Si$  and  $Al_2Cu$  is main responsible intermediate compound for hardness [15].



**Figure 6:** Microstructure of sand cast of 20 mm section size.

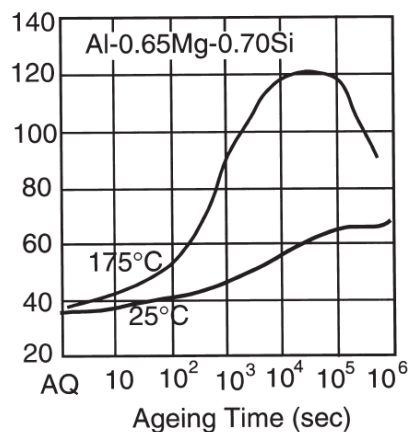
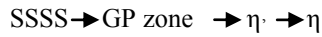

**Figure 7:** Graph of hardness vs. ageing time for 6XXX alloy.

In 6XXX series aluminium alloys a lot of study has been done. New channels in these alloys are mixing other elements such as Ti, Ag etc and study their effect on the properties. Composite formation using 6XXX series aluminium alloys or studying welding techniques for these alloys are also new subjects of research.

**2.5 7XXX series aluminium alloys**

In 7XXX series aluminium alloys main constituents are Mg and Zn. But sometimes for better strength and unique mechanical properties some amount of Cu and Si is also added. Small amount of iron is also added in some kind of these alloys. These alloys are highly age hardenable; the precipitation sequences in these series alloys are,



Where SSSS stands for supersaturated solid solution, equilibrium η phase is MgZn<sub>2</sub> and it is also main hardness providing phase. η phase occupies {111}α habit plane in Al matrix. η phase has a=0.496 nm, c=1.4042 nm and nine orientation from η<sub>1</sub> to η<sub>9</sub>. The structure of η<sub>2</sub> is such that, (100)<sub>η2</sub>//{110}α and (001)//{111}α but due to lack of higher imaging technologies the shape, structure and orientation of GP zones and of η phases are not found or have less study. But it is found that in GP zones there is equal amount of Mg and Zn. When Cu is added in 7XXX series aluminium alloys quaternary intermetallic compounds are seen in microstructures [2]. In 2001, B.B.Verma and his co-workers explain about the effect of constituents alloying compounds on the fatigue behaviour. They found that, thermomechanically treated 7475 Al-alloy has superior strength, ductility fracture toughness and fatigue life. General precipitation also opposes crack propagation [16]. In 2014, a researcher explains dynamic fracture behaviour of 7075 -T6 aluminium alloy. They found that, this alloy provides good yield strength, ductility and fracture toughness. During fracture of this alloy large size of dimples are seen telling that intermetallic particles are coarser. The intermetallic particles are mainly precipitated in the grain boundary region there are precipitation free zones in the alloy microstructure. Hence in 7XXX series aluminium alloys energy required for crack propagation is larger than crack formation [17]. There is large scope for research in the microstructure analysis for 7XXX aluminium alloy. Due to lack of high magnification imaging technologies structure, orientation and nature is not found yet.

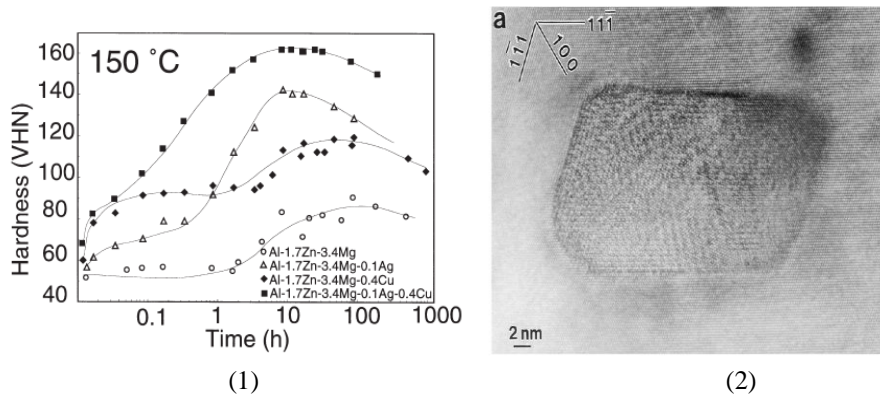

**Figure 8:** (1) Graph of hardness vs time for typical 7XXX series aluminium alloy. (2) High resolution transmission electron micrograph from the Al-1.7Zn-3.4Mg-0.1Ag

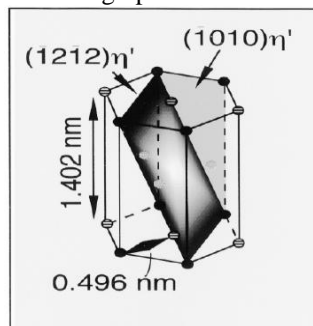

**Figure 9:** Bravais lattice structure for η

**III. Conclusion**

After studying and reviewing several research papers about general aluminium alloys we find that, a comparatively high study is done for 2XXX, 6XXX and 7XXX series aluminium alloys. These alloys are

typically used for high strength to weight ratio. Remaining alloys are studied for achieving different kind of superior mechanical properties like formability, fluidity, castability etc. A very few studies are found over the actual design of components, though they are formed commercially but it is not delivered in the research paper form. There are few case studies about aluminium alloys. Hence designing new automobile or useful parts by alloys and reporting the problems during their formation is a new for research.

A complete new research field is there if one can think about mixing of two dissimilar series aluminium alloys or forming components partially by one alloy and partially by other alloy. This kind of study is not reported yet. The research work should be done over the research gap that is mentioned in this review paper at the end of description of each alloy series.

### References

- [1]. D.Shechtman, I.A.Blech, material transactions A, volume 16A, June, 1985, pp 1005-1008
- [2]. S.P.Ringer, K.Hono, Microstructural evolution and age hardening in aluminium alloys: atom probe field-ion microscopy and transmission electron microscopy studies. Material characterisation 44,2000,pp.101-131
- [3]. E.R.delosRios, M.Trooll, A.Levers, improving the fatigue crack resistance of 2024-T351 aluminium alloy by shot peening, university of Sheffield,department of mechanical engineering, pp. 26.1-26.8
- [4]. M.A.Rekik, A.Rebhi, N.Njah, the effect of copper addition on microstructural parameter of an aluminium alloy processed by equal channel angular pressing, physics procedia 2, 2009, pp. 1271-1279
- [5]. A.May, M.A.Belouchrani, S.Taharboucht, A.Boudras, influence of heat treatment on the fatigue behaviour of two aluminium alloy 2024 and 2024 plated, procedia engineering 2, 2010, pp. 1795-1804
- [6]. Ch.V.A.Narasayya, P.Rambabu, M.K.Mohan, Rahul Mitra, A.Eswara Prasad, tensile deformation and fracture behaviour of an aerospace aluminium alloy AA2219 in different ageing conditions, procedia material science 6, 2014,pp. 322-330
- [7]. P.Parz, M.JFaller, R.Pippan, W.Puff, R.Wurchum, defects in Al-3wt%Cu after high pressure torsion studied by two dimensional Doppler broadening spectroscopy, physics procedia 35, 2012,pp. 10-15
- [8]. Arun Bahadur, intermetallic phases in Al-Mn alloys, national metallurgical laboratory, journal of material science 23, 1988, pp 48-54
- [9]. John A. Taylor, iron containing intermetallic phases in Al-Si based casting alloys, procedia material science 1, 2012, pp 19-33
- [10]. K.Raju, S.N.Ojha, effect of spray forming on the microstructure and wear properties of Al-Si alloys, procedia material science 5, 2014,pp 345-354
- [11]. R.Saravanan, R.Sellamuthu, determination of the effect of Si contain on microstructure, hardness and wear rate of surface refined Al-Si alloys, procedia engineering 97, 2014, pp 1348-1354
- [12]. K.Kittner, A.Feuerhack, W.Forster, C.Binotsch, M.Graf, recent developments for the production of Al-Mg compounds, materials today: proceeding 25, 2015, pp S225-S232
- [13]. H.Q.Wang, W.L.Sun, Y.Q.Xing, microstructure analysis on 6061 aluminium alloy after casting and diffuses annealing process, physics procedia 60, 2013, pp 68-75
- [14]. K.T.Akhil, Sanjivi Arul, R.Sellamuthu, the effect of section size on cooling rate, microstructure and mechanical properties of A356 aluminium alloy in casting, procedia material science 5, 2014, pp 362-368
- [15]. S.Dutta, M.S.Kaiser, recrystallisation kinetics in aluminium piston, procedia engineering 90, 2014,pp 188-192
- [16]. B.B.Verna, J.D.Atkinson, M.Kumar, study of fatigue behaviour of 7475 aluminium alloy, bulletin of material science,vol.24 no:2,april 2001,pp. 231-236
- [17]. Ming-zhiXING, Yong-gang WANG, Zhao-xui JIANG, dynamic fracture behaviours of selected aluminium alloys under three point bending, defence technology 9, 2013, pp.193-200