

## **MPPT CONTROLLER BASED SOLAR TRACKING SYSTEM**

Bala Kalanithi<sup>1</sup>, S.Rajesh<sup>2</sup>

<sup>1</sup> PG.Scholar, Department of Mechatronics Engineering, Jeppiaar Engineering College, Chennai

<sup>2</sup> Assistant Professor, Department of Mechanical Engineering, Jeppiaar Engineering College, Chennai

---

**ABSTRACT:** Solar energy is a very large, inexhaustible source of energy. The Renewable Energy as a source is focused to bring the awareness towards the Green Energy System which provides the pollution free environment. Also it has no heavy mechanical section and is free from noise. The power from the sun intercepted by the earth is approximately 1.8X10<sup>11</sup>MW, which is many thousands of times larger than the present consumption rate on the earth of all commercial energy sources. Solar tracking system which can be used as a power generating method from sunlight. This method of power generation is simple and is taken from natural resource. This needs only maximum sunlight to generate power. This project presents for power generation and sensor based solar tracking system to utilize the maximum solar energy through solar panel by setting the equipment to get maximum sunlight automatically. This proposed system is tracking for maximum intensity of light. When there is decrease in intensity of light, this system automatically changes its direction to get maximum intensity of light. The proposed method is to design an electronic circuit to sense the intensity of light and control the DC motor driver for the panel movement, and construct a Buck-Boost converter for to step-up and step-down the voltage, and store the maximum utilized output voltage in Lead-Acid Battery.

**Keywords:** Solar energy, Solar tracking, MPPT, Boost Converter, Renewable energy, Microcontroller

---

### **I. INTRODUCTION**

The modern industries depend on solar system for various applications which are most common in the world. Solar energy is becoming increasingly attractive as we grapple with global climate changes. However, while solar energy is free, non-polluting, and inexhaustible, solar panels are fixed. As such, they cannot take advantage of maximum sunlight as weather conditions and seasons change. A solar panel receives the most sunlight when it is perpendicular to the sun's rays, but the sunlight direction changes regularly with changing seasons and weather. Currently, most solar panels are fixed, i.e., the solar array has a fixed orientation to the sky and does not turn to follow the sun. To increase the unit area illumination of sunlight on solar panels, we designed a solar tracking electricity generation system. The main use of this paper is to utilize the maximum power from the sun. Now a day we are in heavy need to use the solar power as in the coming days everything we use might depend on this kind of systems.

Pei-Wen Li et al.,(2013) describe a fundamental modeling for the optical features and control algorithm has been developed for a solar stove heat collection system which uses a giant Fresnel lens. The modeling work helps to implement autonomous solar tracking in the system by controlling the Fresnel lens to maintain a stationary focal point on the heat-collecting surface of the solar stove. Two-axis solar tracking for the particular work was chosen. Ibrahim Sefa.,(2009) et al, describe the Electric energy is essential to maintain daily life and industrial activities. Turkey uses mainly fossil fuels to produce electricity. Generation of electricity from fossil fuels is the primary source of air pollution and greenhouse gas emissions.

Arbab et al.,(2009) describe a computer tracking system of solar dish with two-axis degree freedoms based on picture processing of bar shadow. The sun tracking system of a solar dish based on computer image processing of a bar shadow is investigated. Chin et al.,( 2011) describe the Design, modeling and testing of a standalone single axis active solar tracker using MATLAB/Simulink. This paper presents the design, modeling and testing of an active single axis solar tracker. The compactness of the proposed solar tracker enables it to be mounted onto the wall. Almukhtar et al.,(2013 ) describe the Design of Phase Compensation for Solar Panel Systems for Tracking Sun. The compensation for solar panel systems in order to tracking sun has been studied and represented in its equivalent closed loop control system.

### **II. EXPERIMENTAL ANALYSIS**

The objective of this paper is to evaluate one of the alternative technologies currently available in the daily life to generate electricity from the solar cells. Due to rising costs of conventional energy and their limited

resources, photovoltaic energy becomes a promising energy with advantages such as the absence of any pollution and the availability with more or less large quantities anywhere in the world.

**2.1. BLOCK DIAGRAM OF PROPOSED METHOD**

Fig(1) shows that the light sensor detect the light from sun through Ldr sensor ,controller circuit received the signal from sensor and gave direction to the driver for movement of solar panel with the help of x and y axis driver. finally buck-boost converter received the voltage from panel to storage purpose in lead acid battery.

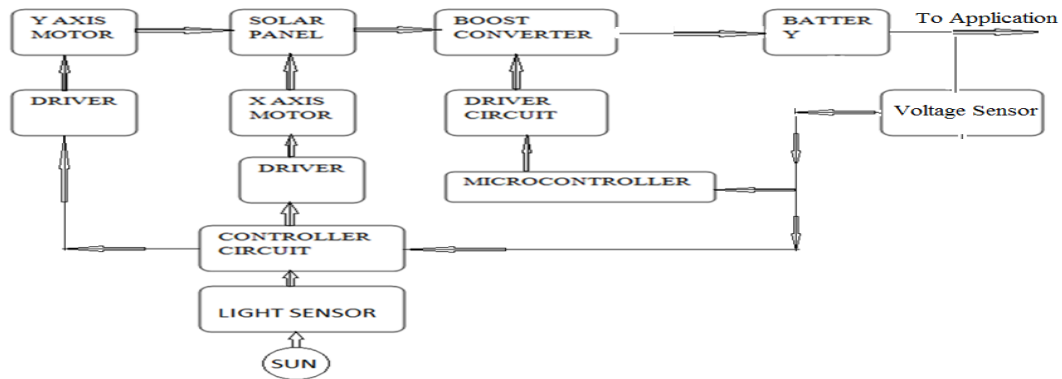

**Fig.1. Block Diagram**

**2.2 SELECTION OF MATERIAL**

In this paper various components used to achive required voltages like solar panel, lead acid battery, motor driver, At mega 16 microcontroller, controller circuit, buck-boost converter, ldr sensor etc. detail of this materials are given below,

**2.2.1. SOLAR PANEL**

The solar array or panel is defined as a group of several modules electrically connected in series-parallel combinations to generate the required current and voltage.



**Fig.2.Solar Panel**

Solar Panel Absorbs Energy from sunlight and converts into electrical energy by using photo voltaic cell. The photovoltaic cell converts Sun light Energy directly into electricity.

**2.2.2. DC GEARED MOTOR (X AND Y AXIS)**

A Driver Motor mainly consists of a DC motor and Gear System and controlled by Motor Driver Circuit. Gear motors allow the use of economical low-horsepower motors to provide great motive force at low speed. They are used in lifts, winches, medical tables, jacks and robotics and have high torque at relatively low shaft speed.

**2.2.3. MOTOR DRIVER (L298)**

The Motor Driver Controls the Motor Forward/Reverse Direction and Speed. This motor driver module controls the speed and direction on 2 DC motors, up to 40V 3A. The module itself is powered and controlled from a main board but the motors are powered from a separate power source. A battery can be safely used to power the input on the power module (a red module, like USB Client DP) and also power the motors, by wiring the battery to both.

#### **2.2.4. DRIVER CIRCUIT (TLP 250)**

The Photo-coupler consists of LED and a integrated photo detector. This is suitable for gate driving circuit of IGBT or power MOS FET. its photo-IC couplers are housed in compact packages. They Have Ability to drive IGBTs and power MOSFETs directly, makes system design easier. The Photo Couplers offers High Reliability for Drive Operations, simpler circuit configurations and improves system Stability.

#### **2.2.5. MICROCONTROLLER AT MEGA 16**

AT Mega16 has High-performance, Low-power Consuming 8 bit Microcontroller with Advanced RISC Architecture. The Register File is optimized for the AVR Enhanced RISC instruction set. Its Status Register contains information about the result of the most recently executed arithmetic instruction. The ALU operations are divided into three main categories – arithmetic, logical, and bit-functions. Finally the Status Register is not automatically stored when entering an interrupt routine and restored when returning from an interrupt.

#### **2.2.6. BATTERY**

A Battery is two or more electromechanical cells which store chemical energy and make it Available in an electrical form. There are two types ,Primary batteries (disposable batteries)Non Rechargeable & Secondary batteries (rechargeable batteries). The lead–acid rechargeable batteries have a much harder life. They can withstand Vibrations, shock, heat, cold, and have long Life .

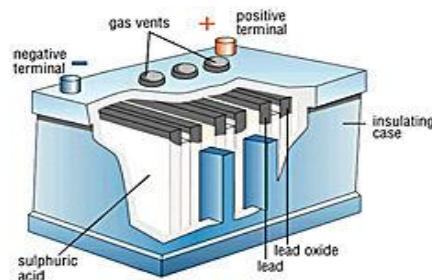

**Fig.3. Battery**

#### **2.2.7. BUCK-BOOST CONVERTER**

The buck–boost converter is a type of DC-to-DC converter that has an output voltage magnitude that is either greater than or less than the input voltage magnitude. Two different topologies are called buck–boost converter. Both of them can produce a range of output voltages, from an output voltage much larger (in absolute magnitude) than the input voltage, down to almost zero.

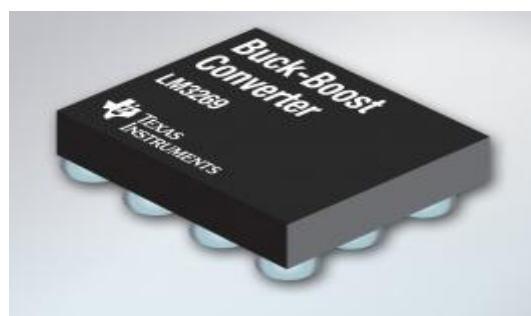

**Fig.4. Buck-Boost Converter**

### 2.2.8. LDR SENSOR

A photoresistor or light dependent resistor (LDR) or photocell is a resistor whose resistance decreases with increasing incident light intensity; in other words, it exhibits photoconductivity. A photoresistor is made of a high resistance semiconductor. If light falling on the device is of high enough frequency, photons absorbed by the semiconductor give bound electrons enough energy to jump into the conduction band. The resulting free electron (and its hole partner) conduct electricity, thereby lowering resistance.



**Fig.5. LDR Sensor**

## III. RESULT AND DISCUSSION

Simulation is the imitation of the operation of a real-world process or system over time. The act of simulating something first requires that a model be developed. The model represents the system itself, whereas the simulation represents the operation of the system over time. The proposed intelligent MPPT algorithm needs less constructed data, and no learning procedure so it can be easily implemented using a microcontroller in the future.

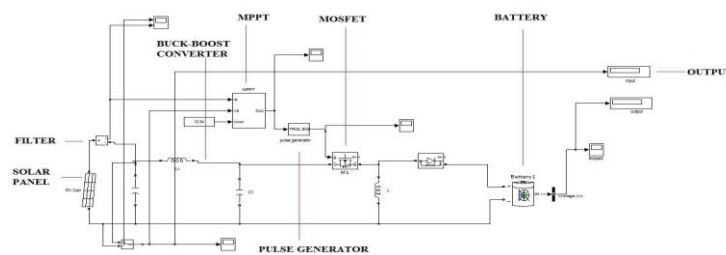

**Fig.6. Simulation Circuit**

## IV. PERFORMANCES

In mathematics, and more specifically in graph theory, a graph is a representation of a set of objects where some pairs of objects are connected by links. The interconnected objects are represented by mathematical abstractions called **vertices**, and the links that connect some pairs of vertices are called edges.

### 4.1. PV Voltage and Current

The solar array or panel is defined as a group of several modules electrically connected in series-parallel combinations to generate the required current and voltage.

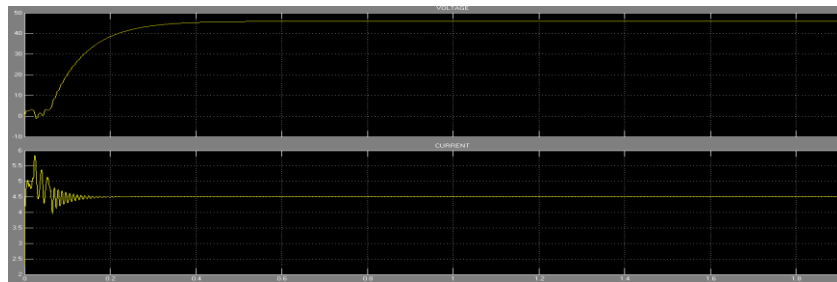

**Fig.7. Voltage vs Current**

#### 4.2.Pulses

Two oscillators would be used for generating square waves. The sensors are connected to these two oscillators which generate square pulses in accordance to the intensity of the light falling on the sensors

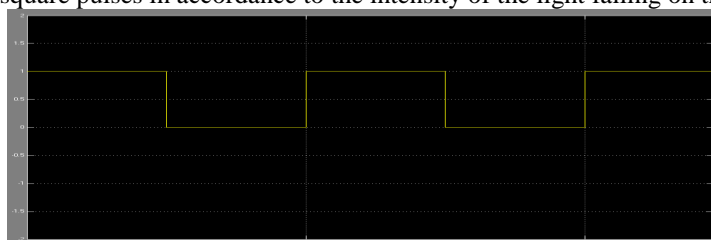

**Fig.8. Pulses**

#### 4.3.Output Voltage

Battery stored the final output voltage from Buck-Boost Converter. Power supplied by solar arrays depends upon the insolation, temperature and array voltage. It is also the function of the product of voltage and current. By varying one of these two parameters; voltage or current, power can be maximized.

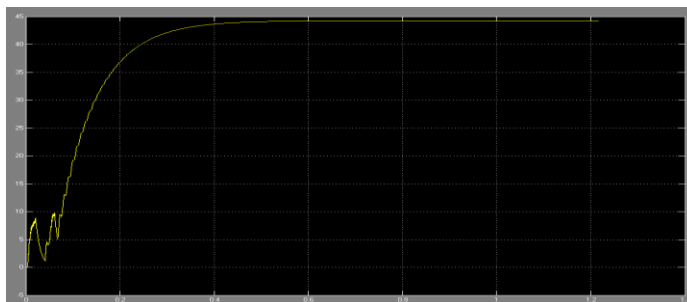

**Fig.9. Output**

### V. CONCLUSION

The sun-tracker and charge controller systems have been successfully implemented as explained. This method combined the extension theory with a buck-boost converter to speed up responses for reaching the accurate MPPT of solar panel arrays under solar insolation and ambient temperature changes. Result shows the MPPT controller can fast track the maximum power point, has better response and lower oscillation under rapid atmospheric conditions. The simulation results demonstrate the effectiveness and robustness of the proposed method. Power system could be applied to small-scale systems such as residential appliances, Electricity production, water treatment, heating- cooling and ventilation, Architecture and urban planning, Transport and reconnaissance etc.

### REFERENCE

- [1] Pei-Wen Li , Peter Kane , Matthew Mokler " Modeling of solar tracking for giant Fresnel lens solar stoves" in elsevier scindirect, Available online 16 August 2013.

- [2] Ibrahim Sefa, Mehmet Demirtas, Ilhami Çolak "Application of one-axis sun tracking system" in Energy Conversion and Management elsevier scindirect Available online 26 July 2009.
- [3] H. Arbab, B. Jazi, M. Rezagholizadeh " A computer tracking system of solar dish with two-axis degree freedoms based on picture processing of bar shadow" in elsevier scindirect Available online 8 August 2008.
- [4] C.S. Chin et al describe the "Design, modeling and testing of a standalone single axis active solar tracker" using MATLAB/Simulink in elsevier scindirect Available online 2 February 2012.
- [5] Ali H. ALmukhtar "Design of Phase Compensation for Solar Panel Systems for Tracking Sun" in elsevier scindirect TerraGreen 13 International Conference 2013 - Advancements in Renewable Energy and Clean Environment.