

## Arch Bridges - A Perfect Complement to Hilly Surroundings

Satish Nag<sup>1</sup>, Alok Panday<sup>2</sup>

1(National Highway Division, HPPWD, Himachal Pradesh, India)

2(Elegant Consulting Engineers, Ghaziabad, India)

---

**Abstract:** Arch bridges have been known for their unparalleled aesthetics since ages. Though there is very little or rather seems to be no scope to improve it further, an effort has yet been made to enhance it for various arch bridges constructed in the state of Himachal Pradesh, India. The present paper primarily discusses about the aesthetics and features of Baner khad bridge (NH88), Trilokpur bridge (NH20) and Nagrota nallah bridge (NH20) which have recently been constructed in the state of Himachal Pradesh. The Baner khad (river) bridge is a unique "unsymmetrical framed arch bridge" which not only has a distinct graceful look but also unmatched features of both arch bridges as well as integral bridges. The unsymmetrical shape of the bridge which was insisted by the presence of a small hillock towards one end of the bridge has added innocence to the bridge as it did not involve painful destruction to the beautiful hilly surroundings. Trilokpur and Nagrota nallah bridges are open spandrel arch bridges of similar type with different span lengths and heights. Aesthetics of these two bridges has been further enhanced by introducing an opening with curved top in the piers and flaring the piers at the top with smooth curvature till edge of the carriageway. Doing this has added improved performance to the bridges too. Bearings have been completely eliminated from these bridges and expansion joints have been provided only at the junction of bridge and approach roads.

**Keywords:** Aesthetics, Arch Bridge, Durability, High Performance, Integral Bridge

---

### I. Introduction

Though arch bridges have been known as substitute to "elegance", the beautiful hilly surroundings to arch bridges over Baner khad (river), Trilokpur khad & Nagrota nallah inspired to add further grace to these bridges. Efforts were therefore made to have aesthetics of the bridges which truly merges with the scenic surroundings. The Baner khad bridge (Photo 1 & 2 and Fig.1a & 1b) has a central unsymmetrical arch span of 90m (between springing points) and about 11m difference in the founding level at the two ends due to presence of a small hillock on one side. The bridge length has been further extended by about 8m on one side and 14m on other side (resulting into total bridge length of about 112m) with the help of inclined outwards piers and longitudinal beams which are in line with the arch ribs. The unsymmetrical shape of the bridge along with varying depth of arch ribs, inclined piers, integral connections and curved haunches offered a distinct graceful look to the bridge. The curved haunches not only improved the aesthetics of the bridge but also resulted into smooth and uniform stress flow from one component to other component of the bridge. The inclined outward piers helped upto certain extent in counter balancing the horizontal forces produced by the arch ribs at the springing points and thereby helped in economizing the proposal too.

Trilokpur and Nagrota nallah bridges (Photo 3 & 4 and Fig.2 to 4) have parabolic arches with span length of 45m and 35m respectively between springing points. The shape and profile of piers supporting deck slab have been so selected that it adds to the bridge aesthetics. The parabolic profile of arch ribs along with variable thickness has enhancing impact on arch aesthetics. Elimination of bearings from these bridges has not only added aesthetics but also additional features of integral bridge to these bridges. i.e. enhanced performance under seismic/flood conditions, prolonged durability, better riding quality and least maintenance requirements due to absence of the bearings and intermediate expansion joints.

The complexity of the shape specifically in the Baner khad bridge made the design interesting and created much more than expected challenges while detailing the bridge at certain locations where reinforcing bars were passing in five different directions (Photo 5 & 6).

The carriageway width and total deck width of all the bridges are 7.5m and 12m respectively. The bridges have been supported over open foundations and designed to carry two lanes of traffic and for high seismic forces of zone V.

### II. Structural System

The structural system of the Baner khad bridge primarily consists of three number of arch ribs (with varying depth)/piers/beams placed at a spacing of 3.5m c/c in the transverse direction. Thickness of the arch

ribs, inclined piers and longitudinal beams is 800mm. Depth of the arch ribs varies from 2m near crown to 3m near springing points (more near curved haunches). The piers and longitudinal beams have uniform depth of 3m and 2m respectively. The arch ribs and inclined piers are braced in the transverse directions with 1000mm x 1500mm bracings to have enhanced lateral stability specifically during seismic conditions. At the deck level, 500mm x 1500mm cross beams are provided at a spacing of about 10m to brace the arch ribs/longitudinal beams in the transverse directions and support the deck slab. Thickness of the deck slab is 250mm with due consideration given to the span of the slab. Founding levels on two sides of the bridge are at a depth of 26.5m and 15.3m respectively below the formation level of the bridge. Foundation sizes at higher and lower end are 15.00m(W) x 20.73m(L) and 17.50m(W) x 15.00m(L) respectively. At the higher end, abutment is resting over the same foundation supporting the arch ribs. At the lower end, independent abutment has been provided with founding level at a relatively higher level (with due consideration given to the conditions of subsurface soil) to avoid large abutment height.

The structural system for Trilokpur and Nagrota nallah bridges consists of 7.5m wide arch rib of parabolic profile and varying thickness which support the piers supporting the deck slab. The span (between springing points), thickness of arch rib at springing & crown and height of arch rib above springing for Trilokpur bridge are 45m, 1000mm, 500mm & 16m respectively. For Nagrota nallah bridge these are 35m, 800mm, 400mm & 12.5m respectively. The thickness of the piers which are spaced at an interval of 5m in both the bridge are 600mm and 500mm respectively except the end piers of Trilokpur bridge where it is 1000mm due to large height of piers (about 18m below deck slab). The thickness of the deck slab for both the bridges are 450mm at the center which gradually reduces to 200mm at the tip to achieve the cross slope. The size of the open foundations for Trilokpur bridge and Nagrota nallah bridge are 13.5m(L)x12.3m(W) and 9m(L)x12.3m(W) respectively.

### **III. Structural Models, Design Standards And Parameters**

Three dimensional grillage models (Fig.5 & 6) were prepared to analyze the bridges for various load effects including high seismic forces as per the provisions of IRC: 6- 2000.

Basic design standards:	IRC: 5- 1998, IRC: 6- 2000, IRC: 21- 2000 & IRC: 78- 2000
Type of sub-surface soil:	Consisted of dense sand & gravel in Baner khad & Nagrota nallah bridges and moderately weathered & moderately strong SHALE in Trilokpur bridge
Net safe bearing capacity:	40-45 t/m <sup>2</sup> at founding level of various bridges based on the permissible settlement of 25 mm
Coefficient of friction:	0.50 (between foundation & sub-surface soil)
Carriageway width:	7500mm
Overall deck width:	12000mm
Loading considered:	Dead load (self-weight & superimposed dead load), two lanes of live load (Class-A/70R-Tracked/70R-Wheeled), braking forces, footpath live loads, earth pressure, global temperature change ( $\pm 35^{\circ}\text{C}$ ), shrinkage (equivalent temperature fall of $17.10^{\circ}\text{C}$ ), differential settlement of supports (12.5mm) and seismic forces (zone factor = 0.36, average response acceleration coefficient = 2.5, importance factor = 1.5 as per IRC: 6 and response reduction factor = 3.5 as per "AASHTO LRFD Bridge Design Specifications". Finally horizontal seismic coefficient was calculated as 19.3%).
Load combinations:	As per IRC: 6- 2000 (structural design of bridge components) & IRC: 78-2000 (base pressure checks) Except deck slab, design of bridge components was generally governed by the load combination with temperature and seismic forces.
Modulus of elasticity:	Short term modulus of elasticity was considered to analyze the bridges for various load effects except for global temperature change, shrinkage and differential settlement of supports for which long term modulus of elasticity equal to half the short term modulus of elasticity was considered
Moment of inertia:	Cracked moment of inertia equal to 0.7 times the gross moment of inertia was considered to take advantage of flexibility of structure specifically for forces due to temperature changes

Grade of concrete:	M35 for various component of bridges except for arch ribs, piers, beams/bracings and deck slab of Baner khad bridge where M40 grade concrete was used.
Grade of steel:	Fe500 grade
Permissible stresses:	100% for "Load Combination I" consisting of forces excluding those due to temperature change, shrinkage, differential settlement of supports and seismic forces 115% for "Load Combination II" consisting of forces in Load Combination 1 & those due to temperature change, shrinkage, differential settlement of supports but excluding seismic forces 125% (base pressure check) & 150% (structural design) for "Load Combination III" consisting of all forces including seismic forces

#### IV. Conclusion

The purpose of a bridge is not only to carry the traffic, it should also be so planned and shaped that it truly merges with the surrounding specifically at locations of scenic surroundings. Looking at the bridges discussed above, it can be realized that how a little bit of emotions and respect towards the nature can create bridges which not only has elegance but also many appreciable merits such as enhanced performance during stringent seismic/flood conditions, improved durability, better riding quality and least maintenance requirements associated with the bearings & intermediate expansion joints.



Photo 1: Baner khad bridge on NH88 (Himachal Pradesh)



Photo 2: Baner khad bridge on NH88 (Himachal Pradesh)



Photo 3: Trilokpur bridge on NH20 (Himachal Pradesh)



Photo 4: Nagrota nallah bridge on NH20 (Himachal Pradesh)



Photo 5: Reinforcement cage for foundation, arch ribs & piers (Baner khad bridge)



Photo 6: Reinforcement cage for foundation, arch ribs & piers (Baner khad bridge)

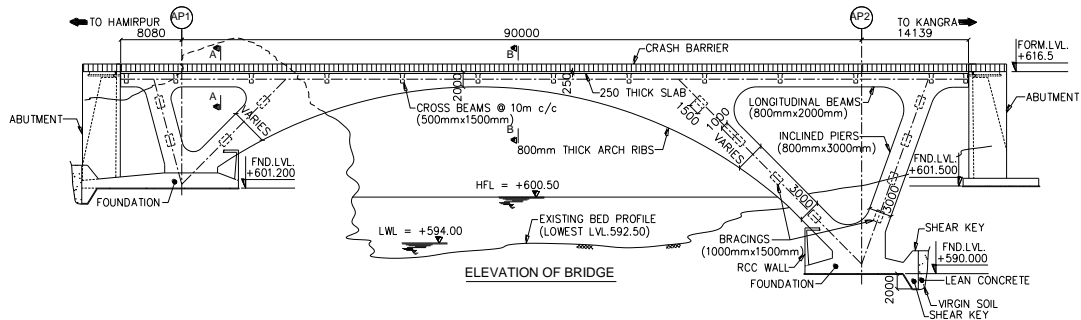

Fig. 1(a): Elevation of the Baner khad bridge

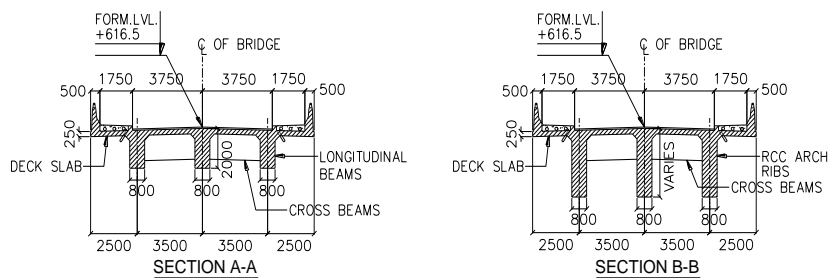

Fig. 1(b): Sections of the Baner khad bridge

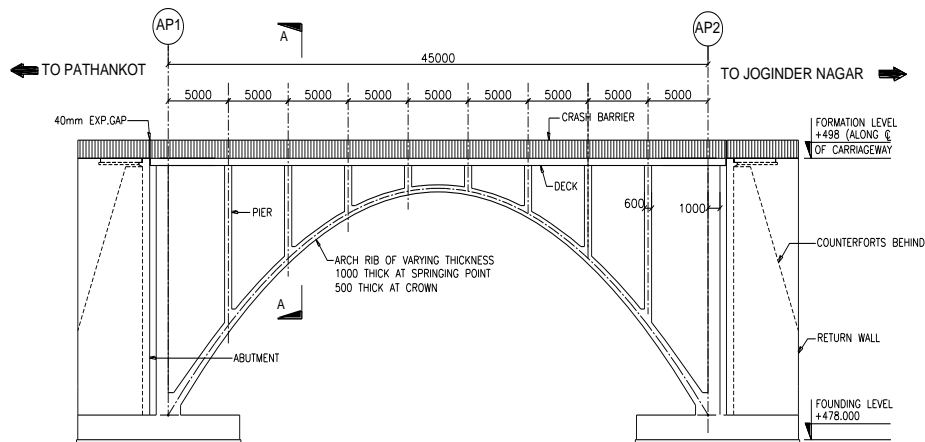

Fig. 2: Elevation of the Trilokpur bridge

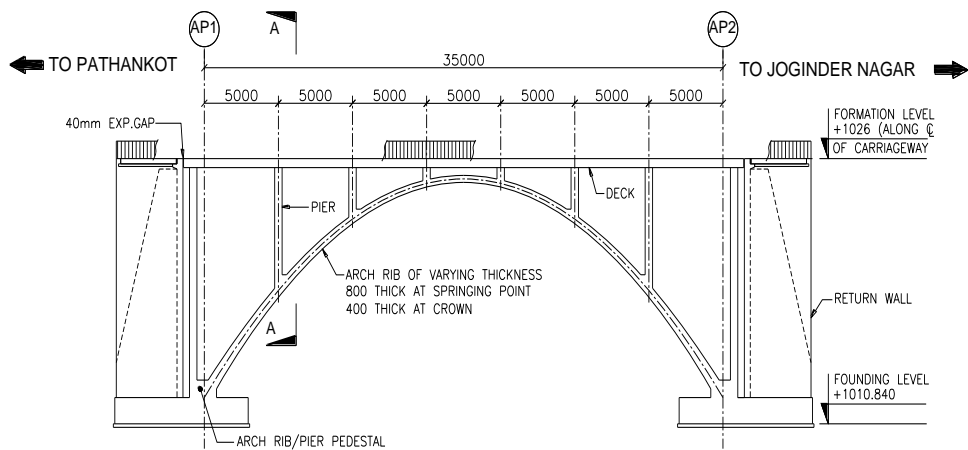

Fig. 3: Elevation of the Nagrota nallah bridge

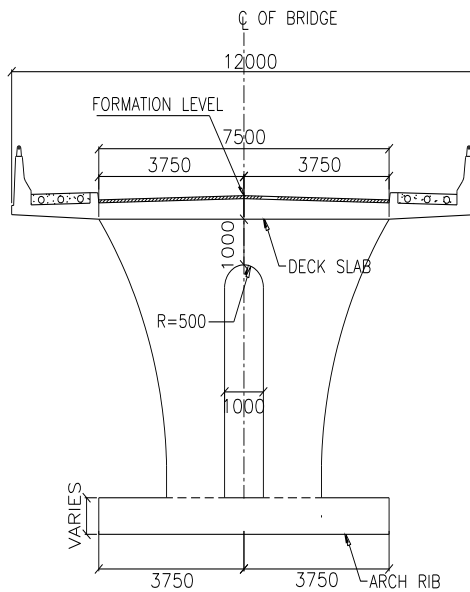

Fig. 4: Typical section of the Trilokpur bridge & Nagrota nallah bridges

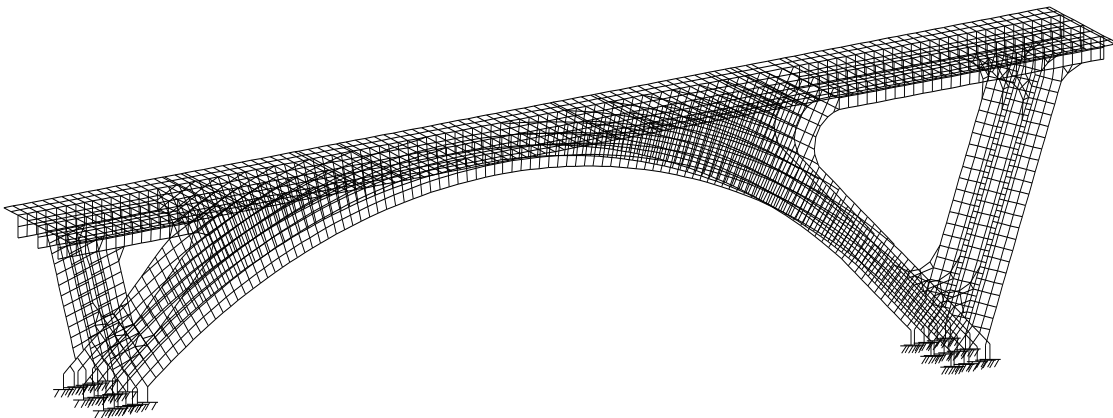

Fig.5: Structural model of the Baner khad bridge

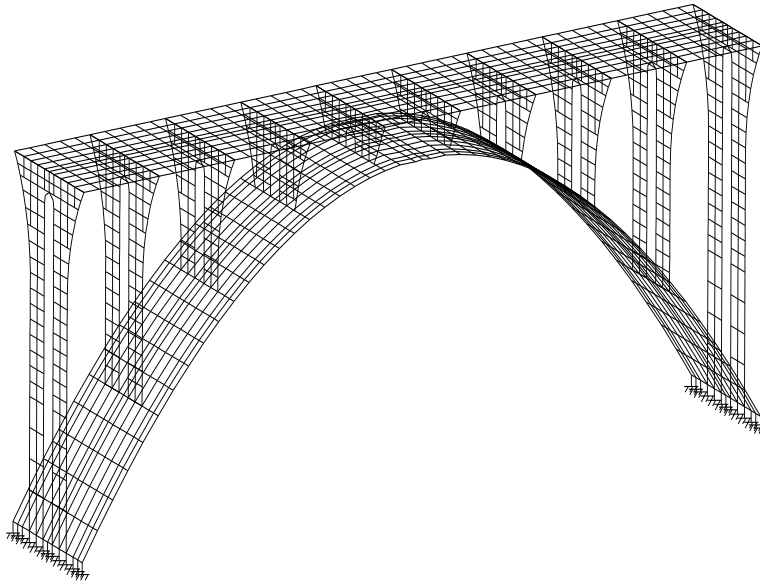

Fig. 6: Structural model of the Trilokpur bridge & Nagrota nallah bridges