

DC-DC booster with cascaded connected multilevel voltage multiplier applied to transformer less converter for high power applications

Elezabeth Skaria¹, Beena M Varghese²

¹(Electrical and Electronics Engineering, M.A.College of Engineering, India)

²(Electrical and Electronics Engineering, M.A.College of Engineering, India)

Abstract: This paper proposes a high step-up dc-dc converter having a multiplier stage based on the Cockcroft-Walton (CW) voltage multiplier without a step-up transformer, which provides continuous input current with low ripple and high voltage ratio. For a given input voltage, a different output voltage boost up with different gain can be generated with the components of same specifications. Since the five level converter circuits uses five multiplier, more gain can be achieved. The proposed converter can provide a suitable dc source for any level multilevel inverter. In this paper, the control strategy employs two independent frequencies, one at high frequency, thereby minimize the size of the inductor and the other one at low frequency for a reduced output voltage ripple.

Keywords: Cascaded Cockcroft Walton , DC-DC converter , Voltage multiplier

I. Introduction

THE recent growth of high powered applications and low voltage storage elements are increasing the demand of efficient step-up dc-dc converters. Certain applications demanding high power with high static gains are renewable power generation system, embedded systems, fuel cells, mobility applications and uninterrupted power supply (UPS). But the output power generated is not so much sufficient for high power applications. So it should have to be step up to suitable level by means of certain step up converter. The step-up stage normally is the critical point for the design of high efficiency converters due to the operation with high input current and high output voltage, thus a careful study must be done in order to define the topology for a high step-up application. Some classical converters with magnetic coupling as fly back or current-fed push-pull converter can easily achieve high step-up voltage gain [1] . However, the power transformer volume is a problem for the development of a compact converter. The energy of the transformer leakage inductance can produce high voltage stress, increases the switching losses and the electromagnetic interference (EMI) problems, reducing the converter efficiency.

DC-DC converters can be used as switching mode regulators to convert an unregulated dc voltage to a regulated dc output voltage. The regulation is normally achieved by PWM at a fixed frequency and the switching device is generally BJT, MOSFET or IGBT. The minimum oscillator frequency should be about 100 times longer than the transistor switching time to maximize efficiency. This limitation is due to the switching loss in the transistor. The transistor switching loss increases with the switching frequency and thereby, the efficiency decreases [2]. The core loss of the inductors limits the high frequency operation. Control voltage V_c is obtained by comparing the output voltage with its desired value. Then the output voltage can be compared with its desired value to obtain the control voltage V_{cr} . The PWM control signal for the dc converter is generated by comparing V_{cr} with a reference voltage V_r . There are four topologies for the switching regulators: buck converter, boost converter, buck-boost converter and cuk converter.

DC-DC converter using a transformer with an asymmetrical pulse is being used for the voltage boost up [3], but the converter section is complex and requires an isolation circuit. A new alternative for the implementation of high step-up structures is proposed in this paper with the use of the voltage multiplier cells integrated with classical non-isolated dc-dc converters. The uses of the voltage multiplier in the classical dc-dc converters add new operation characteristics, becoming the resultant structure well suited to implement high-static gain step-up converters. The problem of using a transformer can be overcome by the usage of a suitable booster converter without a transformer and a multiplier circuit employing cascaded connected multiplier unit. The voltage multiplier can be cascaded with any number of multiplier units consisting of diode and capacitor combinations. Non-isolated dc-dc converter as the classical boost, can provide high step-up voltage gain, but with the penalty of high voltage and current stress, high duty-cycle operation and limited dynamic response. The diode reverse recovery current can reduce the efficiency when operating with high current and voltage levels. There are some non-isolated dc-dc converters operating with high static gain, as the quadratic boost converter, but additional inductors and filter capacitors must be used and the switch voltage is high .

II. Cascaded Voltage Multiplier

A high step-up converter based on Cockcroft Walton voltage multiplier replacing the step-up transformer is shown in fig.1. A multistage CW voltage multiplier with the boost-type structure is considered here. The proposed converter provides higher voltage ratio than that of the conventional CW voltage multiplier. Thus, the proposed converter is suitable for power conversion applications where high voltage gains are desired. Moreover, the converter operates in continuous conduction mode (CCM), so the switch stresses, the switching losses, and EMI noise can be reduced as well.

2.1. Cockcroft Walton Voltage Multipliers

The classic multistage diode/capacitor voltage multiplier, popularized by Cockcroft and Walton, is probably the most popular means of generating high voltages at low currents at low cost. It is used in virtually every television set made to generate the 20-30 kV second anode accelerating voltage from a transformer putting out 10-15 kV pulses. It has the advantage of requiring relatively low cost components and being easy to insulate. It also inherently produces a series of stepped voltages which is useful in some forms of particle accelerators, and for biasing photomultiplier tube dynodes [4]. The CW multiplier has the disadvantage of having very poor voltage regulation, that is, the voltage drops rapidly as a function of output current. In some applications, this is an advantage. The output V/I characteristic is roughly hyperbolic, so it serves well for charging capacitor banks to high voltages at roughly constant charging power. Furthermore, the ripple on the output particularly at high loads, is quite high.

The Cockcroft Walton or Greinacher design is based on the Half-Wave Series Multiplier, or voltage doubler. In fact, all multiplier circuits can be derived from its operating principles. It mainly consists of a column of smoothing capacitors (C2,C4), a column of coupling capacitors (C1,C3), and a series connection of rectifiers(D1,D2,D3,D4). The following description for the 2 stage CW multiplier, assumes no losses and represents sequential reversals of polarity. The number of stages is equal to the number of smoothing capacitors between ground and OUT, which in this case capacitors C2 are and C4.

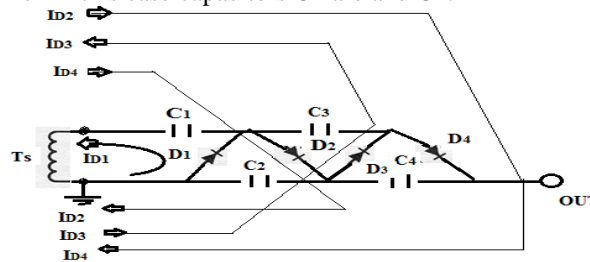

Fig.1. Two stage multiplier circuit

2.2. Modification to The Basic Cockcroft Walton Multiplier

In some applications, an additional capacitor stack is connected to the output capacitor stack in the above design. This is particularly popular in electrostatic accelerator applications and high voltage x-ray systems, where low ripple is desired. A modification to the classic CW multiplier, uses two charging stacks driven by out of phase input voltages. This is particularly useful when the charging stack capacitors are significantly smaller than the output filter capacitors. The modification is illustrated in the following fig.2.

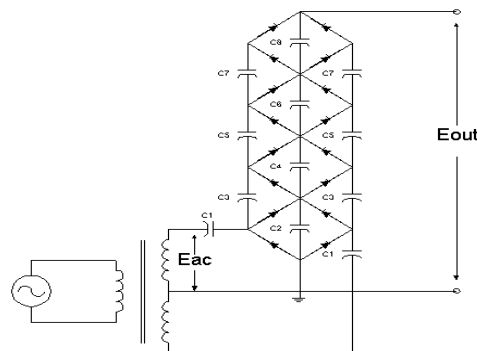

Fig.2. Multi stage multiplier circuit

1) A three stage multiplier

The given dc-dc converter as in fig.3 deploys four switches, in which Sc1 and Sc2 are used to generate an alternating source to feed into the cascaded voltage multiplier and Sm1 and Sm2 are used for the control of the inductor energy to obtain a boost performance. If we are using a transformer for step up the input voltage

may increase the complexity and cost of the converter because an isolated circuit is necessary to drive the power semiconductor switches [5]. Now, In the proposed converter, the four switches operate at two independent frequencies, which provide coordination between the output ripple and system efficiency and with same voltage level, the number of semiconductors in the proposed converter is competing with some cascaded dc-dc converters. The cascaded connection depending on the series of capacitors and diodes, the output gets multiplied the input voltage as in fig.3. The dc output formed by series capacitors is suitable for powering multilevel inverters. In the past few decades, high-voltage dc power supplies have been widely applied to industries, science, medicine, military, and, particularly in test equipments, such as X-ray systems, dust filtering, insulating test, and electrostatic coating.

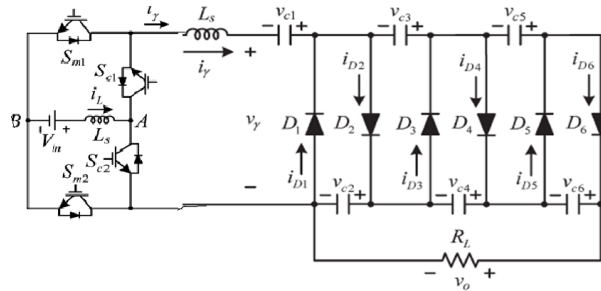

Fig.3. Three stage multiplier circuit

2.3.Design considerations of proposed converter

The voltage stress, current stress, switch voltage of the proposed cascaded Cockcroft Walton converter is being discussed here.

2.3.1. Capacitor voltage stress

In the steady-state condition, In an n-stage CW voltage multiplier, all capacitors are large, which has same voltage level, but the first one has only about half of the other capacitors. So the maximum voltage stress on each capacitor, is $V_{o,pk}/n$, but that for the first one is $V_{o,pk}/2n$, where $V_{o,pk}$ is the maximum peak value of the output voltage.

$$\text{Capacitor voltage } V_{ck} = V_{in} / (1 - D) \text{ for } k = 1$$

Actually the capacitor voltage of the converters are depending upon the number of cascaded stages, but here in this converter the capacitor voltages depends on the input voltage and duty ratio. So the capacitor rating can be easily determined.

2.3.2. Switch voltage and current stresses

The maximum current and voltage stresses on the switches are I_{pk} and $V_{o,pk}/2n$, respectively, where I_{pk} is the maximum peak value of input current[7], which burdens the overall output voltage, the voltage stress of the switches in the rest of the converters is similar to that of the conventional boost converters.

$$\text{Switch voltage} = V_{in} / (1 - D)$$

2.3.3.Diode voltage and current stresses

Similarly, the maximum current and voltage stresses on the diodes in the proposed converter are I_{pk} and $V_{o,pk}/n$, respectively.

$$\text{Diode voltage} = 2V_{in}/(1 - D)$$

$$\text{Voltage Gain } M_v = 2n / (1 - D)$$

The voltage stress of the diodes is twice as large as that of the switches. It demonstrates the voltage stress on the diodes in the proposed converter and other topologies.

2.3.4. Capacitance of CW voltage multiplier

A major advantage of the cascaded connected voltage multiplier is that the voltage gain is theoretically proportional to the number of cascaded stages. Since, when a load is connected to the load side of the system, the voltage drop and ripple across each capacitor cannot be ignored. Usually a voltage-fed mode, in which the

input terminal of the CW voltage multiplier was fed by a sinusoidal voltage source, was used for analyzing voltage drop and ripple for CW multipliers.

$$\text{Capacitor voltage } V_{ci} = I_o / F_{sc} C = (2ni + 1) / 2 \text{ For } i = 1; 2; \dots; 2n$$

Here for analyzing the voltage drop and ripple, an equivalent discontinuous-pulse-type current source is fed into the CW voltage multiplier. According to the current-fed mode analytical principle presented the voltage drop and ripple associated with each capacitor can be found by the charge discharge behavior of capacitors under the steady-state condition.

III. Simulation Circuit And Results

3.1 Three stage multiplier

Figure given shows the circuit model as in MATLAB simulation for a three stage multiplier unit.

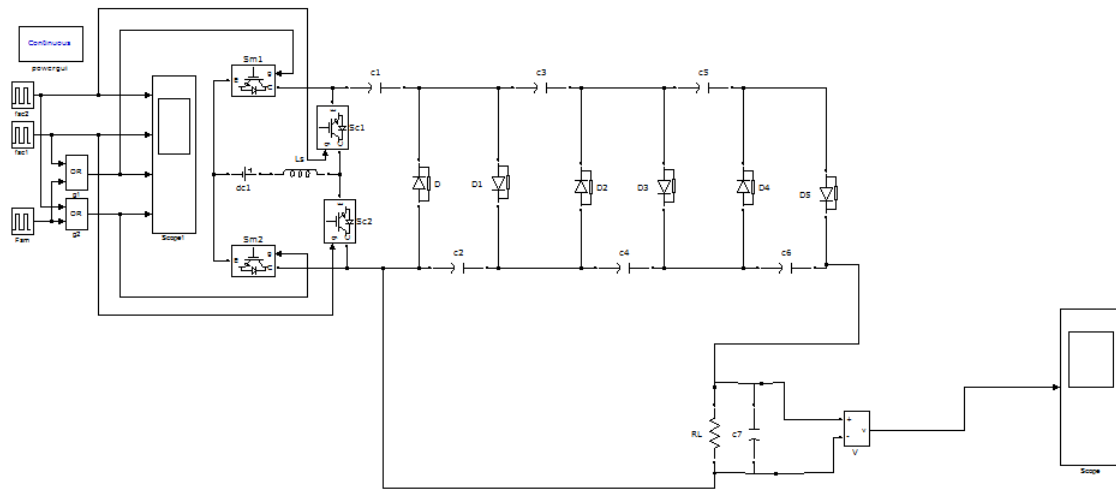

Fig.4. Three stage multiplier circuit

The simulation circuit of a three stage voltage multiplier is shown in fig.4. Here multiplier circuit uses three capacitors and three diodes and thereby a voltage boost up instead of transformer is possible with a gain of 10.7.

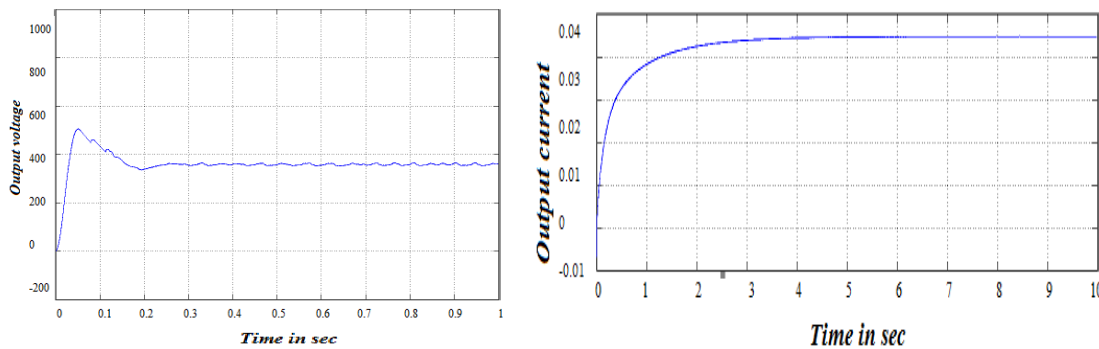

Fig.5. Output voltage and current of three stage multiplier

Fig. 5 given shows the resultant voltage and current obtained for the three stage multiplier. The output voltage is of 320V and current is of .035A. The capacitor and inductor specifications are of 470µF and 1.5mH respectively.

3.2 Five stage multiplier

The simulation circuit of a five stage multiplier is shown in the fig. 6. Here the converter section employs five multiplier cells for voltage boost up consisting of five diodes and five capacitors. Since the boost up DC output is not much convenient for high power applications directly, it should have to be converted to ac by means of an inverter.

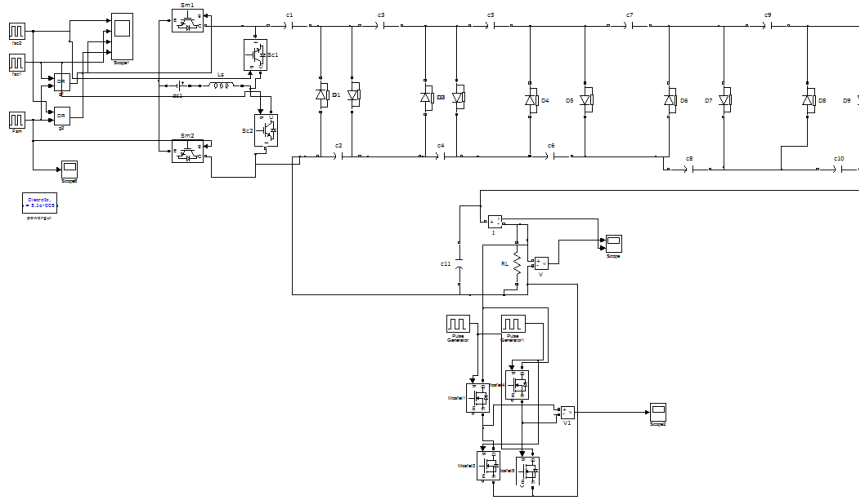

Fig.6. Five stage multiplier circuit

The resultant output voltage for a five stage converter is shown in fig 7.a. The output voltage boost up to 420V and inverted ac output of the inverter is shown in fig.b and fig.c. The same capacitor and inductor rating of 470 μ F and 1.5mH respectively is used for the boost up which provides a gain of 14.7, since the multiplier cell consists of five set of diodes and capacitors instead of three .

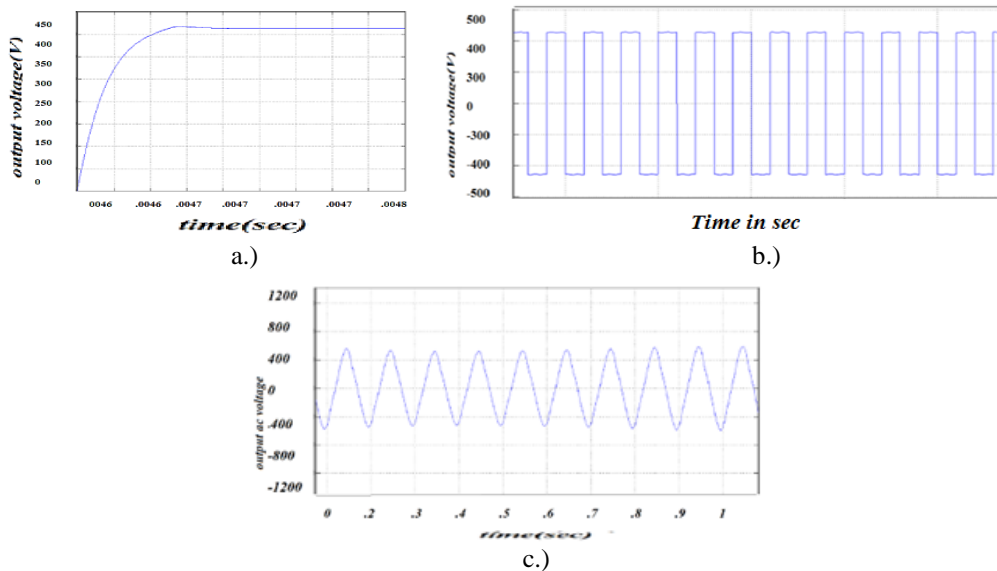

Fig.7. Five stage multiplier circuit

IV. Conclusion

A dc-dc booster converter with a cascaded connected voltage multiplier without a transformer is used for step up the voltage for high power applications are employed here. The converter uses either of three stage or five stage multiplier and thereby high voltage gain can be achieved. The power components with the same voltage ratings can be selected since the voltage stress on the active switches, diodes, and capacitors is not affected by the number of cascaded stages. The proposed control strategy employs two independent frequencies, one of which operates at high frequency to minimize the size of the inductor while the other one operates at relatively low frequency according to the desired output voltage ripple. The simulation results proved the validity of theoretical analysis and the feasibility of the proposed converter.

References

- [1]. L. S. Yang, T. J. Liang, and J. F. Chen, Transformerless dc-dc converters with high step-up voltage gain, IEEE Trans. Ind. Electron., vol. 56, no. 8, pp. 3144-3152, Aug. 2009.
- [2]. G. R. Walker and P. C. Sernia, Cascaded dc-dc converter connection of photovoltaic modules, IEEE Trans. Power Electron., vol. 19, no. 4, pp. 1130-1139, Jul. 2004.
- [3]. Hyun-Lark Do, Asymmetrical Full-bridge Converter With High-Voltage Gain, IEEE transactions on power electronics vol.27, no 2, February 2012.

- [4]. Chung-Ming Young, Member, IEEE, Ming-Hui Chen, Student Member, IEEE, TsunAn Chang, Chun-Cho Ko, and Kuo-Kuang Jen Cascade CockcroftWalton Voltage Multiplier Applied to Transformerless High Step-Up DCDC Converter, *IEEE Trans. Ind. Electron.*, vol. 60, no. 2, February 2013.
- [5]. M. Prudente, L. L. P_tschler, G. Emmendoerfer, E. F. Romaneli, and R. Fules, Voltage multiplier cells applied to non-isolated DC-DC converters, *IEEE Trans. Power Electron.*, vol. 23, no. 2, pp. 871887, Mar. 2008.
- [6]. W. Li and X. He, Review of nonisolated high-step-up dc/dc converters in photovoltaic grid-connected applications, *IEEE Trans. Ind. Electron.*, vol. 58, no. 4, pp. 12391250, Apr. 2011.
- [7]. M. W. Ellis, M. R. Von Spakovsky, and D. J. Nelson, Fuel cell systems: Efficient, exible energy conversion for the 21st century, *Proc. IEEE*, vol. 89, no. 12, pp. 18081817, Dec. 2001.
- [8]. J. Wang, F. Z. Peng, J. Anderson, A. Joseph, and R. Bu_enbarger, Low cost fuel cell converter system for residential power generation, *IEEE Trans. Power Electron.*, vol. 19, no. 5, pp. 13151322, Sep. 2004.R. J. Wai, W. H. Wang, and C. Y. Lin, "High-performance stand-alone photovoltaic generation system", *IEEE Trans. Ind. Electron.*, vol. 55, no. 1, pp. 240250, Jan. 2008
- [9]. N. Mohan, T. M. Undeland, and W. P. Robbins, *Power Electronics*, 2nd ed. New York: Wiley, 1995, pp. 172178.
- [10]. A. L. Rabello, M. A. Co, D. S. L. Simonetti, and J. L. F. Vieira, An isolated dc-dc boost converter using two cascade control loops, in *Proc. IEEE ISIE*, Jul. 1997, vol. 2, pp. 452456.