

## **Impacts of an intermittent photo-voltaic power source on a distribution network**

Jeyakumar. K<sup>1</sup>, S.Roshni<sup>2</sup>

*1(Department Of Electrical Engineering, Gandhi Engineering College, India)*

*2(Department Of Electrical Engineering, Gandhi Institute For Technology, India)*

---

**Abstract:** *The reconciliation of the photovoltaic (PV) nearby planetary group to the current conveyance networks has carried new difficulties to the organization organizers. One of the most fascinating difficulties is to forestall the effects of the PV irregular character on the consistent state framework activity conditions. Thus, the principle point of the current work is to examine the impacts of the PV power discontinuity on voltage execution, ordinary generator every day conduct and programmed voltage controller activity. Reproductions are effectuated on 33-transport IEEE spiral conveyance power framework. Furthermore, so as to give a dependable report, a genuine PV power profile is adjusted in this examination. The considered organization is demonstrated and reenacted when the PV entrance and afterward a near report is set up. Gotten results over a time of 24 hours uncovered that the PV coordination adds to an upgrade of the general voltage profile, an extensive sparing in the aggregate sum of the delivered dynamic force and a decrease of intensity misfortunes; yet then again, the PV discontinuous character causes noteworthy change in transports voltages every day profiles just as changes underway day by day plan. To summarize, this paper reports the changes, brought about by the PV source discontinuity, which must be contemplated by the conveyance networks organizers to keep up the general organization boundaries inside safe working condition*

**Keywords—** *Conventional generator Distribution power system Photovoltaic source PV intermittence.*

---

### **I. Introduction**

In recent years, the electricity sector has seen an exponential development. In many countries a vast movement of deregulation appears. The causes (political will, economic interest, etc.) and the goals (improvement of electric companies, opening of new markets, etc.) of this movement of deregulation are very varied. One of the consequences of the deregulation of the electricity markets is the connection of new means of production [1]. The means used for this new electricity production are very diverse. There are wind farms, cogeneration plants, photovoltaic cells, small hydropower plants, fuel cells and other developments are expected in the future [2].

On the other hand a number of reasons such as: the obligation to reduce the emission of greenhouse gases, the diminution of fossil fuels, the issue of energy independence and sustainable development, have pushed to consider the energy problem not only from the economic point of view, but also from an ecological point of view [3, 4]. This has encouraged many countries to develop their energy systems based on renewable energies[5].

Photovoltaic (PV) solar energy was first developed to meet electrical needs in isolated sites, such as mountain regions, islands and rural areas of developing countries. Since the early 2000s, the development of solar photovoltaic energy has grown exponentially. In fact, the installed capacity in the world has increased from a few Megawatts in the early 2000s to 102 GW at the end of 2012 then 227 GW at the end of 2015 and 300 GW at the end of 2016. The installation rate of photovoltaic solar power is currently more than 70 GW per year[6].

This significant growth of the PV installation has an important impact on the energy system behavior. For this reason, many research works have been conducted to study the effect of PV penetration on power systems. Farhad et al. [7] evaluated the application of custom power devices (DVR and DSTATCOM) to improve voltage unbalance in LV feeders with the presence of rooftops PVs. Another work [8] investigated the impact of a high PV insertion on steady state and transient transmission network stability. In [9] authors studied the effect of a PV with low voltage ride through (LVRT) capability on the transient stability of a synchronous generator connected to an infinite bus.

Although the already cited studies revealed effective outcomes in terms of the impacts of a high PV penetration, they generally eliminated the intermittent character of the solar power system. However, the variability of the PV output has significant consequences which must be completely studied before any other photovoltaic penetration. In light of this fact, the motivation of this work is to investigate the effects of the PV intermittence on the behavior of an existing distribution system. The penetration of such alternating power

source brings a lot of new challenges from the system modeling and simulation point of view. The present research work proposes an efficient methodology and represents all the required models, permitting the examination of the alterations caused by the PV power output variations under a day period. To evaluate the proposed methodology and models, steady state and dynamic simulations are carried out on 33 bus networks where a PV source with a real production profile is connected. Then, the network voltage profile, the conventional generator daily behavior and the automatic voltage regulator operation are reported and analyzed to come up with a planning guide to adapting the regulation program, the power generation daily plan and the protection actions to the new system states.

To do so, firstly, a methodology of study is presented. Then, a simulation model is established. In the next section, the basecase of the considered distribution network is simulated. Finally, the Systems integrated to the network and a comparative study, with the base case, is effectuated to investigate the impacts of the PV intermittent character on the system daily behavior.

## II. Methodology Of Thestudy

Due to the dependency of the PV production to the variation of climatic conditions, the solar PV source is characterized by its variable power output [10]. This intermittent character of the PV has the potential to alter the system daily operation in either negative or positive way [11]. For this reason, the intermittence of the PV source must be considered, and its impacts must be fully studied when analyzing the effects of connecting solar PV source to a distribution network.

As it is described on the flowchart of the study methodology (Figure 1), the analysis of the effects of the PV integration on system behavior is effectuated by comparison of the results of three simulations cases. The first case presents the network without any PV source connected (basecase). In the next case, the PV with the maximum power production level (at solar noon period) is added to the network and then the whole system is simulated. Finally, the last case consists on the simulation of the network behavior over twenty-four hours by adapting a real profile of a PV daily production.

The study methodology is based on the modeling of the different components of the network and the simulation of the entire system under study. System modeling is completed on the basis of theoretical and technical studies. Modeling principles are explained in detail in the next section. For the network simulation, both steady state analysis and dynamic analysis are conducted. Indeed, simulations of the particular states of the system which are the base case (without PV) and the maximum PV production level case are established through a steady state simulation, i.e. based on power flow program execution. However, the simulation of the network with a PV production daily profile requires a dynamic simulation since the instability of the PV power output under a day period represents disturbances to the network.

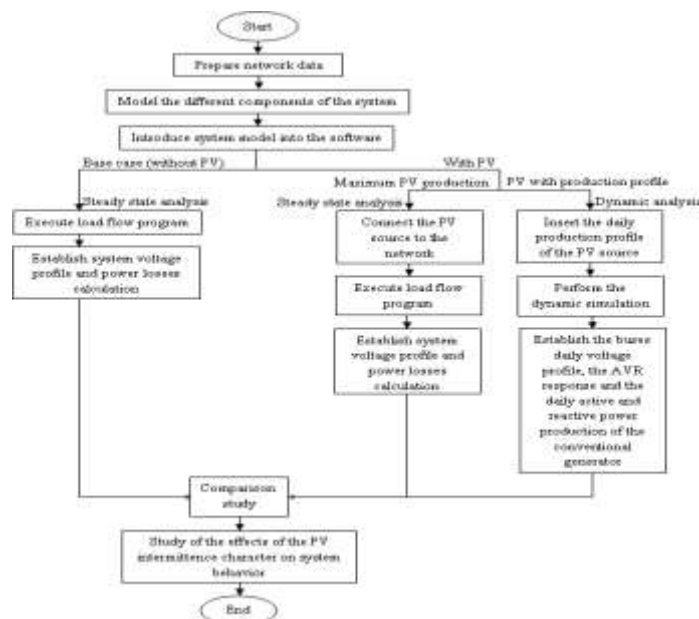

### SIMULATION MODEL

#### Test system presentation

Studies were effectuated on an IEEE standard network, which is a radial distribution system with a base voltage of 12.66 KV and a base apparent power of 10MVar. As shown in Figure 2 the network has a total of 32 PQ buses with active/reactive power consumption of 3.715MW/2.3MVar and one slack bus where

the conventional synchronous generator is connected. The solar photovoltaic system is concentrated at the 6th bus with a peak power generation of 2.4MW.

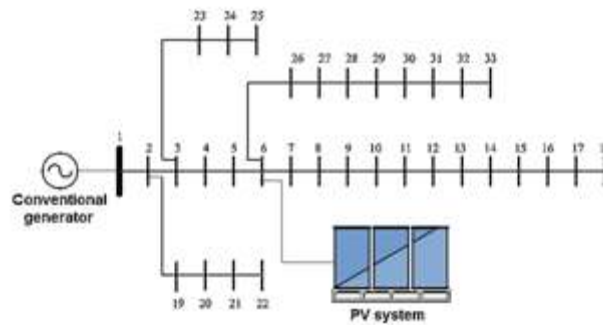

**Conventional generator model**

The conventional generator is a synchronous machine that is presented throughout the simulation with the classical generator transient model. The different generator parameters are depicted in Table 1

**Table 1. Synchronous generator parameters**

Generator Parameters			
Un (KV)	11	Xq (pu)	1.478
Ra (pu)	0.0024	Xq' (pu)	0.24
Xi (pu)	0.0765	Td' (s)	2.35
Xd (pu)	1.89	Tq' (s)	1
Xd'(pu)	0.193	H(MWs/MVA)	1

**Automatic voltage regulator model**

In order to maintain the terminal voltage of the generator constant, the synchronous generator is equipped with an Automatic Voltage Regulator (AVR). The AVR allows the control of the synchronous generators excitation voltage. The principle is to control the synchronous machine reactive power so that its terminal voltage kept at the AVR set value. And this set value is selected in order that the aimed voltage profile of the network is achieved. In fact, under excitation, the machine reacts as an inductor by absorbing reactive power thus inducing a drop in the grid voltage. In opposition, if it is overexcited it provides reactive power inducing an increase in the network voltage. Figure 3 shows a general model of the automatic voltage regulator. The magnitude  $V_{ref}$ , that represents the voltage set-point, is compared to the generator terminal voltage  $V_t$ . Then, the error is amplified to provide the requested excitation voltage  $E_{fd}$ . The time constant and the gain of the amplifier are respectively  $T_a$  and  $K_a$ . The high and the low values of the excitation voltage ( $E_{fd\_Max}$ ,  $E_{fd\_Min}$ ) are fixed by a limiter system [12]. The AVR model parameters are fixed as follows  $K_a=20$ ,  $T_a=0.02$ ,  $E_{fd\_Max}=4$  and  $E_{fd\_Min}=-4$ .

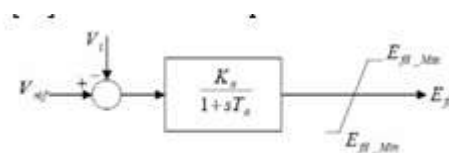

**Photovoltaic system model**

Throughout this work, it is presumed that the PV system doesn't have the potential to produce the reactive power. Hence, the bus with the PV system is modeled as PQ bus with a zero reactive load and a variable negative active load which presents the PV profile. The graph as shown in Figure 4 illustrates a real photovoltaic production profile for different sizes: installation only, region and France [13]. In this study, the PV production profile of a region (green curve) will be adapted. The PV production is characterized by bell-shaped curve centered on solar noon. As it is observed, the power output increases slowly and it has a new value in every minute depending on the insolation variability. So, in order to simplify the data implementation of the PV production profile, we will consider that the PV output is constant during given periods and it is equal to the average power produced during those periods. The resulting profile is presented in the Figure 5 and it is employed throughout the simulation.

To calculate per unit normalized power output the (1) is used and the considered PV peak power (2.4MW) is

exploited as a base value [14].

$$\left( P_{PV} \right)_{pu} = \frac{P_{PV}}{P_{PV}^{max}} \quad (1)$$

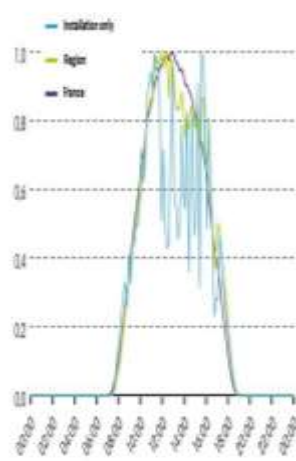

Figure 4. Real production profile for different sizes of photovoltaic source

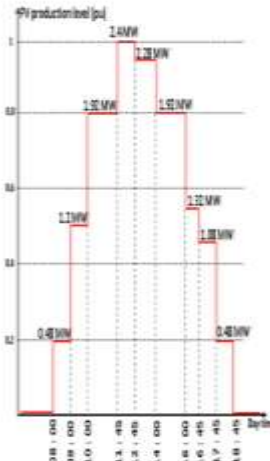

Figure 5. Photovoltaic power output profile adapted in this study

**BASE CASE**

Firstly, the distribution network is simulated without integrating the PV system. Load flow studies are performed using Newton Raphson method. From the obtained results, listed in Table 2, it can be observed that the voltage level ranges from 0.913 pu (bus 18) to 1 pu (bus 1), which means that voltages at all buses are within the operating limit; given that the admissible voltage range is within [90%-105%] of the nominal voltage. It is also mentioned in the same table that the active and the reactive synchronous generator production are respectively 3.918 MW and 2.435 MVar, with active and reactive losses of 0.203 MW and 0.135 MVar.

**Table 2. Power flow results of the base case**

Voltage level (pu)					
Bus	Value	Bus	Value	Bus	Value
1	1	12	0,9268	23	0,9793
2	0,997	13	0,9207	24	0,9726
3	0,9829	14	0,9185	25	0,9693
4	0,9754	15	0,917	26	0,9477
5	0,968	16	0,9157	27	0,9451
6	0,9496	17	0,9136	28	0,9337
7	0,9461	18	0,913	29	0,9255
8	0,9413	19	0,9965	30	0,9219
9	0,935	20	0,9929	31	0,9178
10	0,9292	21	0,9922	32	0,9168
11	0,9283	22	0,9916	33	0,9166
		Active (MW)		Reactive (MVar)	
Total generation		3.918		2.435	
Total loss		0.203		0.135	

**IMPACT ON SYSTEM BEHAVIOR**

At this stage, the already established PV system is integrated to the 33-bus IEEE distribution network. To investigate the effect of its intermittent nature on the network behavior, the PV production follows the previously plotted profile (Figure 5). As it can be observed, against a period of 24 hours, the PV penetration level varies with different steps from 0% to 61.2%, according to (2) [8]. So, the objective of the two next parts is to examine the impacts of those daily changes on voltage profile, synchronous generator behavior and AVR operation. To avoid reaching a high simulation time, assumption about the time scale has been set. Indeed, 1h on the real curves corresponds to 10s in simulation curves.

$$\text{PV Penetration (\%)} = \frac{\text{PV Generation (MW)}}{\text{Base case total generation (MW)}} \quad (2)$$

**Impact on voltage profile**

Simulation results demonstrate that the same voltage behavior is observed in all the network buses. Hence, only the most influential buses voltage variations are depicted in Figure 6. Such a figure shows the voltage profile of bus 1, bus 6 and bus 18 over a period of 24 hours. It is clear from the plot that voltage profiles of buses follow the PV generation profile. In other words, the voltage level rises with the increase of the PV production and declines with the decrease of the PV power output. Thus, voltage profile presents a maximum level during middaytime, i.e. when the PV power output peaks, and it reaches its base case value during early morning and night time. So, we can conclude that the intermittent nature of the PV source causes a significant transformation in buses voltage daily behavior. Consequently, the voltage regulation planning must be updated in accordance with the resulting profiles. This study can also help operators to prevent when voltage violation is likely to happen and, most importantly, to take precautions to avoid overvoltage problem.

To verify the consequence of the maximum PV power injection, the overall voltage profile at solar noon is plotted in Figure 7. It is clear that the voltage magnitude is improved at all buses. Furthermore, all buses voltages are maintained within the permissible operating range and are very near to the nominal voltage. As an instance, the lowest voltage in the system (bus 18) is improved from 0.913 pu to 0.9855 pu. Although, in this case, voltage enhancement is obtained without causing voltage violation, overvoltage must be taken into account especially in the case of a variable consumption or once more distributed generations are added.

In the absence of the PV generation source, the power flow in the distribution network is unidirectional and its magnitude decreases with the increase of the distance from the conventional source. For this reason, in the base case, the voltage of the bus 23 (0.9793 pu) is greater than that of the bus 4 (0.9754 pu) and the bus 5 (0.968 pu). However, we can observe from the Figure 7 that, after integrating the PV source, the voltage of the bus 23 (1.024 pu) became smaller than that of the bus 4 (1.0258 pu) and the bus 5 (1.0244 pu). So, we can conclude that the implantation of the PV source in the network has caused a reversal of the power flow. This change can disturb the selectivity and the sensitivity of the protections. So, to avoid such problem, planners must review the protection plan based on the delivered results.

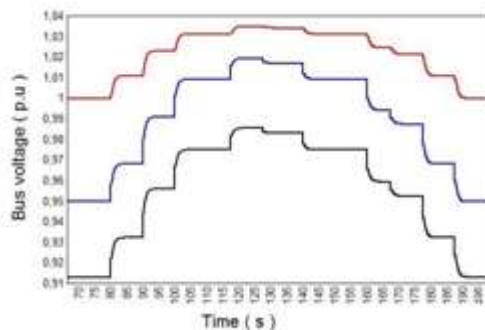

**Figure 6. Daily voltage profile of bus1 (red), bus6 (blue) and bus18 (black)**

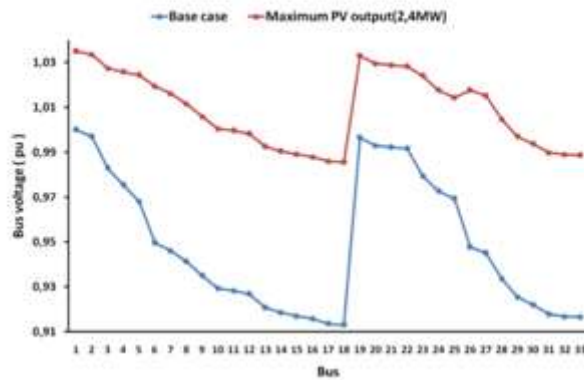

Figure 7. Voltage profile: base case (blue), with PV (red)

### Impact on the synchronous generator behavior

The automatic voltage regulator (AVR) is set to maintain the value of the generator terminal voltage close to 1pu. But the implementation of the photovoltaic source leads to a variation in voltage magnitude. So, the AVR reacted, depending on the case, by decreasing or increasing the excitation voltage of the generator as shown in Figure 8. Indeed, conversely to the generator terminal voltage daily behavior as shown in Figure 9, the excitation voltage of the generator starts decreasing at the beginning of the day, and it reaches a minimum value during midday period, then, it increases gradually to attain its base case value at night.

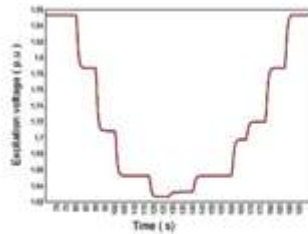

Figure 8. Excitation voltage of the conventional generator

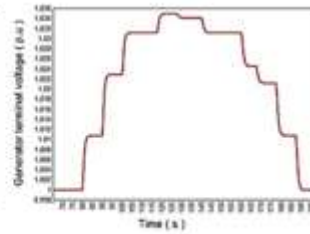

Figure 9. Terminal voltage of the conventional generator

The reactive power produced by the conventional generator over a period of 24 hours is presented in the Figure 10. Observed variations of the reactive power production are due to two reasons. The first is its dependency to the variation of the excitation voltage. And the second is the alteration in the daily behavior of the reactive power losses. In fact, in our case study, the reactive losses decrease with the increase of the PV level penetration and vice versa. So, to maintain the validity of the power supply-demand constraint, established in (3), the generated reactive power follows the same behavior of the reactive losses. Hence, it attains its minimum value (2.37 MVar) during midday period, i.e. when the reactive loss is at its minimum (0.07MVar).

$$Q_G + Q_{PV} = \sum_{i=1}^N Q_{D_i} + Q_L \quad (3)$$

Where  $Q_G$  is the reactive power of the generator at the slack bus,  $Q_{PV}$  is the reactive power of the PV,  $Q_{D_i}$  is the reactive power demand at bus  $i$ ,  $Q_L$  is the reactive power loss and  $N$  is the number of buses. With the penetration of the PV system and in order to conserve the power balance, given in (4), the active power production must be divided between the conventional generator and the PV system. Consequently, as it is shown in Figure 11, the synchronous machine has adapted its production of active power according to the constraints induced by the

intermittent nature of photovoltaic production. Indeed, the synchronous generator is operating now within a range of 3.918 MW to 1.412 MW. Hence, corrective actions must be taken in programming and planning phase to adapt the daily production plan to those alterations.

$$P_G + P_{PV} = \sum_{i=1}^N P_{Di} + P_L \quad (4)$$

Where  $P_G$  is the active power of the generator at the slack bus,  $P_{PV}$  is the active power of the PV,  $P_{Di}$  is the active power demand at bus  $i$ ,  $P_L$  is the active power loss and  $N$  is the number of buses.

We can note from the Figure 10 and the Figure 11 that the conventional generator active power changes with a high rate contrary to the produced reactive power which varies with small rate, causing so alterations in the generator power factor. Indeed, the power factor of the conventional source drops to 0.512 at solar noon. However, operating the generators with a low power factor is not preferred by the network utilities because it alters negatively the overall power system efficiency [15]. Hence, protective actions can be planned to prevent conventional generator reaching this low power factor.

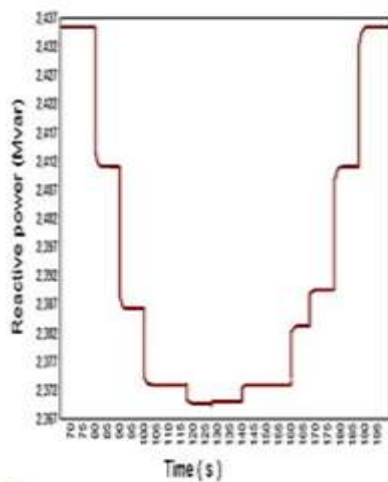

Figure 10. Reactive power of the conventional generator

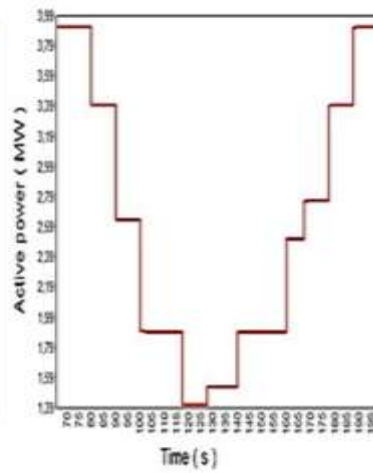

Figure 11. Active power of the conventional generator

### III. Conclusion

This paper aims to study the effects of the PV source intermittence on the behavior of an existing distribution network. To do so, a real PV power output profile is chosen to be adapted in the present research work. Then, detailed simulations were conducted on a 33-bus IEEE radial distribution system. Firstly, load flow studies are effectuated to assess the steady state operation conditions before integrating the PV system. After, the PV power source is penetrated to the considered network and the effects of the PV power output intermittence are studied over a period of 24 hours. Obtained results demonstrate that the PV integration enhances the overall voltage profile and reduces both power losses and active power production. But on the other hand, the PV intermittent character results a considerable transformation in buses voltages daily profiles and an alteration on the power production plan. To avoid such problems, this work can help planning operators to make modification in the regulation program and also in the power generation daily plan. To conclude,

in the context of an electrical power systems deregulation, the observation of a large number of such thematic simulations will allow to acquire a thorough knowledge about the behavior of the system in presence of an intermittent power source and hence to guide planners to decide on protection and defense actions.

### **Acknowledgements**

The present work is financially supported by the Tunisian ministry of high education and scientific research.

### **References**

- [1] Noppatee Sabpayakom, Somporn Sirisumrannukul, "Power Losses Reduction and Reliability Improvement in Distribution System with Very Small Power Producers," *Energy Procedia*, vol. 100, pp. 388-395, 2016.
- [2] G. Matkar, D. K. Dheer, Vijay A.S., Suryanarayana Doolla, "A Simple Mathematical Approach to Assess the Impact of Solar PV Penetration on Voltage Profile of Distribution Network," 2017 National Power Electronics Conference (NPEC) College of Engineering Pune, India, vol. 18-20, 2017.
- [3] Anton Johannes Veldhuis, Matthew Leach, Aidong Yang, "The impact of increased decentralised generation on the reliability of an existing electricity network," *Applied Energy*, vol. 215, pp. 479-502, 2018.
- [4] Salah Eddine Mankour, Ahmed Wahid Belarbi, Mohammed Tarik Benmessaoud, "Modeling and Simulation of a Photovoltaic Field for 13 KW," *International Journal of Electrical and Computer Engineering (IJECE)*, vol. 7(6), pp. 3271-3281, 2017.