

## Mitigation of Power Quality Problems Using DVR in Distribution Network for Welding Load

Manila Garg<sup>1</sup>, Parag Nijhawan<sup>2</sup>

<sup>1,2</sup>Department of Electrical and Instrumentation Engineering,  
Thapar University, Patiala-147001, India.

---

**Abstract:** This paper describes the power quality problems like voltage sag, voltage swell and total harmonic distortion in the distribution network and its severe impact on non-linear load. DVR is one custom power device which can help in mitigating these power quality problems. DVR becomes a very popular device as it can be used for both low and high voltage devices. In this paper, modeling and simulation of DVR for welding power load, its functions, configurations, components and various control strategies are presented. It first analyzes the power circuit of a DVR system in order to come up with appropriate control limitations and control targets for the compensation voltage control. The ZSI will provide ride through during voltage sag without any additional circuit and improve the power factor by reducing the harmonic current and common-mode voltage which will finally increase the reliability and extends the output voltage range. The proposed control scheme is simple to design.

**Keywords:** Dynamic Voltage Restorer (DVR), voltage sags, voltage swells, Total Harmonic Distortion (THD), Z-Source Inverter (ZSI).

---

### I. Introduction

The technology is developing at faster rate in all progressing areas. Power scenario has changed a lot. The issue of power quality has become very critical because of the loads which are sensitive to power quality disturbances. Different loads like adjustable speed drives, energy-efficient lighting etc are major causers and the major victims of power quality problems. All of these devices and other reacts adversely to power quality problems, depending upon the severity of the problems [1]. Power quality problem is an occurrence manifested as a nonstandard voltage, current or frequency that results in failure of end use equipments. As the customer demand is increasing day by day then the reliability of the distribution network has also been increased. One of the major problem we dealt here is power sag. Power distribution system should provide their customers with uninterrupted power supply with smooth sinusoidal voltage at contracted magnitude level and frequency. Mostly non linear loads affect the quality of power supplies as a result purity of waveform of supplies is lost. This ends up producing many power quality problems. For some sensitive devices, a temporary disturbance can cause scrambled data, system crashes, interrupted communications and equipment failure etc. Valuable components can be damaged by power voltage spikes. To solve these above problems, custom power devices come into role. The most efficient and effective modern custom power device used in the distribution network is Dynamic Voltage Restorer (DVR). It appeal includes lower cost, smaller size and its fast dynamic response to the disturbance [2]. A high power factor is standard requirement for welding power supply. DVR is the one who restore the voltage timely and provides best solution to power quality problems. Z-source inverter has a unique impedance network which connects the main circuit to dc power source, which provides a unique feature that is not be observed in any other type of inverter i.e. VSI or CSI [3]. The Z-Source network is utilized to boost the DC-link voltage up-to any desired level by introducing shoot through operation mode, in which the two switching devices in the same leg are simultaneously switched-on to effect a short-circuit of the DC-link.

In this paper, programmable voltage source is used with non- linear load with ZSI for welding load. This paper aims at improving power quality issues of voltage sag, swell, THD at different magnitude for welding power supply using Z-source inverter with high frequency isolations for medium power rating devices. Voltage sag, swell is generated at source point and it is seen that using DVR all issues can be resolve [5]. The design, control and modeling of ZSI has been carried out with the help of sinusoidal pulse width modulation (SPWM) technique under simple boost control method.

### II. System Configuration

Dynamic Voltage Restorer is series connected solid state device and injects voltage into the system in order to regulate the load side voltage. It is generally installed between supply and the critical load feeder at the point of common coupling (PCC). DVR adds some more features like line voltage harmonics compensation, reduction of transients in voltage and fault current limitation. Main parts of DVR are as follows [4] and is shown in Fig 1:

- An injection transformer
- DC charging unit
- Storage devices
- Z-source inverter (ZSI)
- Harmonic filter
- Control and protection system

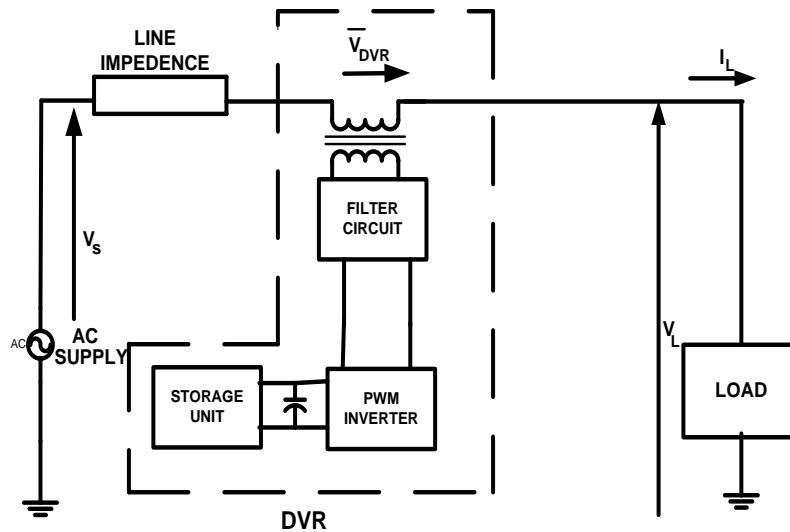

Fig 1: Schematic diagram of DVR

### III. Proposed Welding Power Supply

The schematic diagram of ZSI based welding arc supply is shown in Fig 2. The ZSI has both buck and boost characteristics which helps in obtaining wide range of voltages [6]. The simple VSI and CSI cannot provide such type of feature. It consists of Programmable voltage source supply, diode bridge rectifiers, impedance network, high frequency rectifier, output filter and welding load. A two-port network that consists of a split-inductors and capacitors that are connected in X shape is employed to provide an impedance source (Z-source) coupling the inverter to the dc source, or any another converter [7]. The DC source/load can be either a voltage or a current source/load. The inverter bridge is equivalent to a short circuit when the inverter bridge is in the shoot-through zero state whereas it is equivalent to open circuit when it is in the traditional zero state. When the two inductors ( $L_1$  and  $L_2$ ) are small and approach zero, the Z-Source network reduces to two capacitors ( $C_1$  and  $C_2$ ) in parallel and becomes a traditional VSI. Therefore, a VSI's capacitor requirements and physical size is the worst case requirement for the ZSI. Considering additional filtering and energy storage provided by the inductors, the ZSI should require less capacitance and smaller size compared with the traditional VSI. Similarly, when the two capacitors ( $C_1$  and  $C_2$ ) are small and approach zero, the Z-Source network reduces to two inductors ( $L_1$  and  $L_2$ ) in series and becomes a traditional CSI [6]. Therefore, a traditional CSI's inductor requirements and physical size is the worst case requirement for the Z-Source network. Considering additional filtering and energy storage by the capacitors, the Z-Source network should require less inductance and smaller size compared with the traditional CSI.

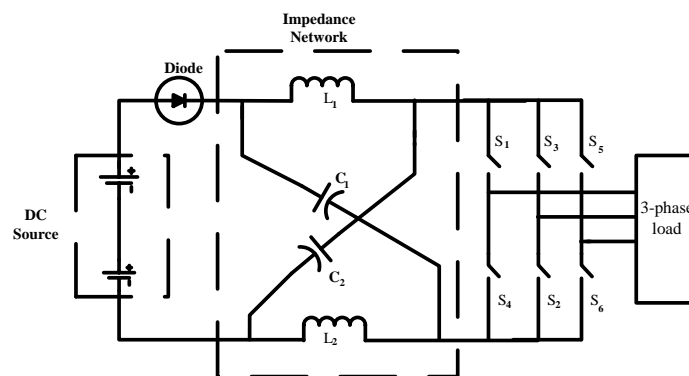

Fig 2: Three-phase Z-source inverter

#### IV. Proposed Method

##### A. Analysis Of Main Circuit

The main circuit of Z-source inverter is shown in Fig 2. The Z-source network consists of diode, two inductors and two capacitors [8]. This impedance network act as a energy filtering element for the inverter. It provides a second order filter which helps the circuit to reduce current and voltage ripples than the capacitor or inductor alone. The dc voltage boost by Z-source network is changed into alternating current through three leg inverter with the help of high frequency transformer which will finally change into dc by the welding load. High frequency transformer isolation is lodge to reduce the cost, weight, size and volume of the transformer used [9]. A high switching frequency is employed for effective PFC action and quick management of the output DC voltage. The switching pairs are switched on alternatively during an each half cycle of the switching period. The rectifier diodes at load side act as free-wheeling diodes when both switching pairs are switched off. A small L-C filter is provided at end of diode rectifier for ripple free output DC voltage. This system provides reliable solution to the faulted system with the help of DVR.

##### B. Control Strategy

A number of pulse width modulation techniques are used to obtain variable voltage and frequency supply. The most widely used PWM technique used for Voltage Source inverter is carrier based sinusoidal pulse width modulation in which we compare two signals, sinusoidal wave and triangular wave with relational operator. A fixed dc input voltage is given to the inverter and controlled output voltage is obtained by switching on and off the components of inverter. The triangular wave (carrier wave) in PWM technique fulfills such requirement that it defines the on and off states by comparing modulating signal with the triangular waveform as shown in Fig 3.

The Z-source utilizes shoot-through zero state to boost the dc voltage and output voltage is greater than the original dc voltage. But this will not affect the PWM of the inverter because it also produces same zero voltage at load terminals[10]. For achieving high output voltage it is required to increase the shoot through duty ratio. Three sinusoidal reference signals and one triangular wave are compared to get firing pulses with shoot through state. The reference signals are displaced by  $120^\circ$ . When the carrier wave is greater than the upper envelope, or lower than the bottom envelope, the circuit turns into shoot-through state.

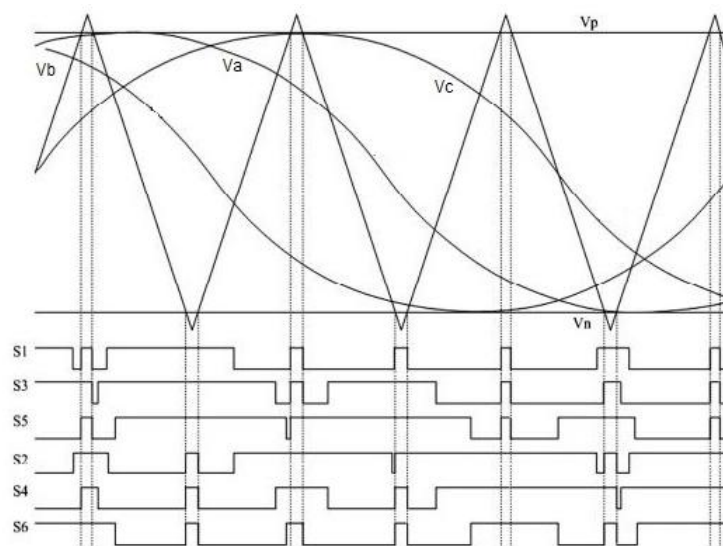

Fig 3: PWM principle

#### V. Modeling And Simulation

To demonstrate the performance of ZSI with programmable voltage source based welding power supply, its model is developed in MATLAB environment along with SIMULINK and power system block set (PSB) toolboxes. The block diagram of ZSI based DVR for improving power quality in a distribution network with welding load is depicted in Fig 4. The value of step magnitude is changed for observing the change in voltage sag, voltage swell by keeping the time variation for starting and ending position fixed. The third harmonic is injected itself in parameter block and it is observed that DVR will remove all harmonics from source side and constant voltage is obtained at load side.

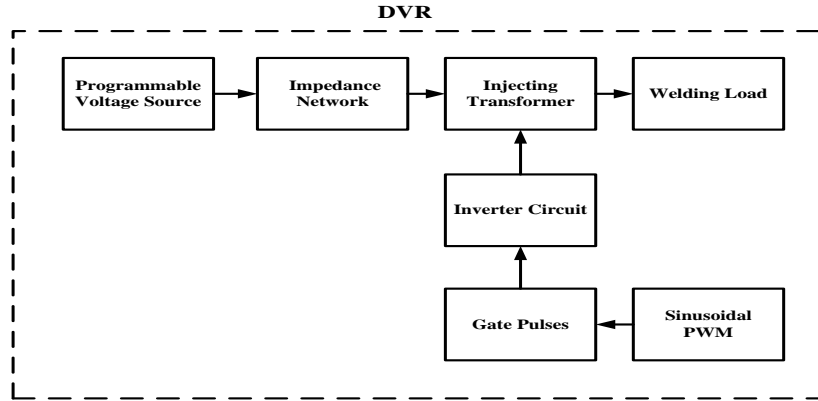

Fig 4: Block Diagram of ZSI for Welding Power Supply

The DC-DC converter plays an important role in removing the current and voltage stresses in power switches when compared with single phase modules. The ZSI has a special feature that it can operate under short circuit conditions also. The voltage regulation is maintained under various load variations of power supply. Based on the design specifications obtained above, simulated results are shown in Figure

Table 1: Circuit Specifications for welding power supply

QUANTITY	ZSI
Input voltage (Vrms) @ 50 Hz	415V
Inductor of Z-source inverter	5.8H
Capacitor of Z-source inverter	5.5mF
Carrier frequency	2KHz
Value of filter, L	15 $\mu$ H
Value of filter, C	10F

## VI. Results And Discussions

Simulation results for proposed welding supply containing voltage sag, voltage swell and THD is discussed in this section. The voltage sag and swell is introduced by the programmable voltage source at the source side which initiates at 0.5 second and remains until 0.75 seconds and it can be observed that with the help of DVR all sag is removed and constant output current ( $I_o$ ) and output voltage ( $V_o$ ) is obtained at load side as shown in Fig 5 and Fig 6, respectively which is the basic requirement of welding.

### A) Voltage Sags

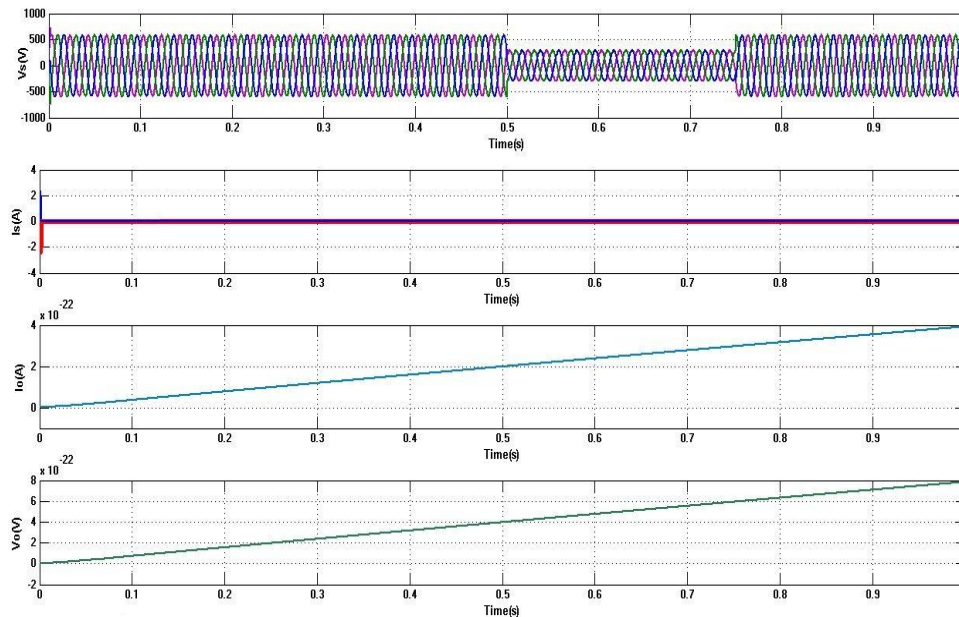
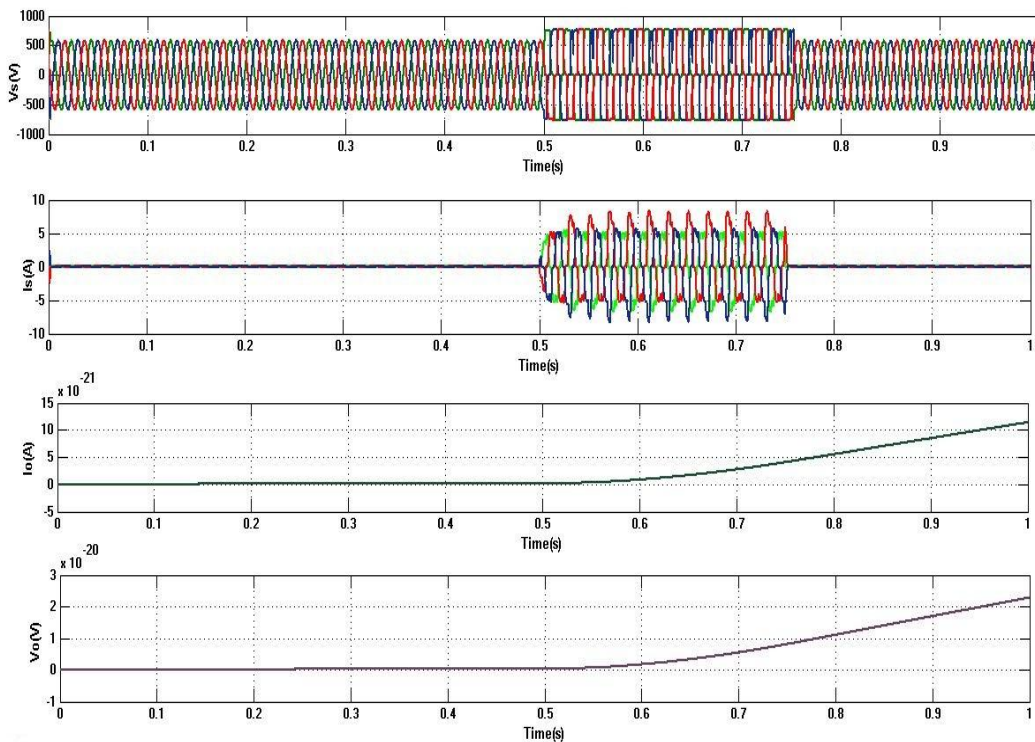

Fig 6: Performance of Proposed Welding Power Supply at 415 V AC Mains to Mitigate Voltage Sag with 0.5 magnitude

**B) Voltage Swells**

The voltage swells may not cause an overvoltage at the dc link. The voltage swell characteristics and the loading conditions are the main issues that determine the energy transfer status from the grid to the DVR. Two cases of measured voltage swells are presented here. As the measured voltage swells are not relatively large, they have not influenced the dc voltage



**Fig 6:** Performance of Proposed Welding Power Supply at 415 V AC Mains to Mitigate Voltage Swell with 0.5 magnitude

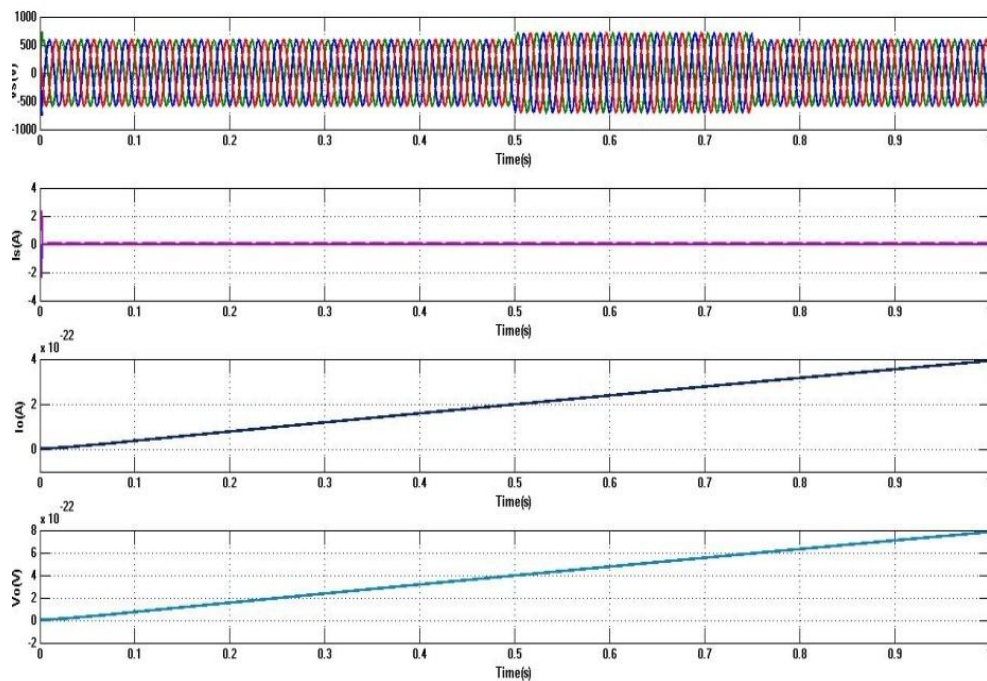

**Fig 7:** Performance of Proposed Welding Power Supply at 415 V AC Mains to Mitigate Voltage Swell with 0.6 magnitude

C) THD in Input Supply

After voltage sag and voltage swell, THD is introduced in the programmable voltage source. It is observed that by injecting different order of harmonics in the voltage source, distortionless output is obtained with constant output and current as shown in Fig 10. This is the best suited method for welding power supply as in this we can change the input voltage widely, and observed that the output voltage can be any value between zero to infinity regardless of input voltage.

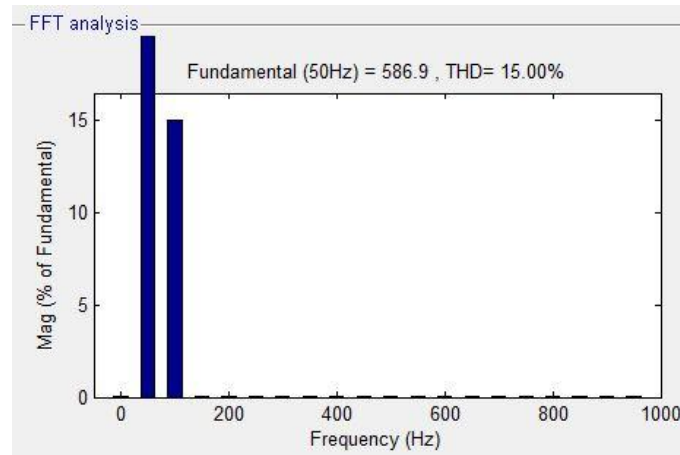

Fig 8: Harmonic Spectrum of input current with injection of 3<sup>rd</sup> Harmonics

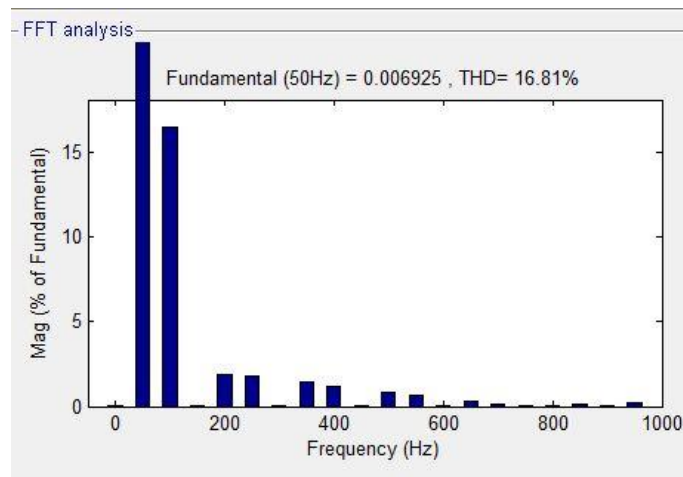

Fig 9: Harmonic Spectrum of input voltage with injection of 3<sup>rd</sup> Harmonics

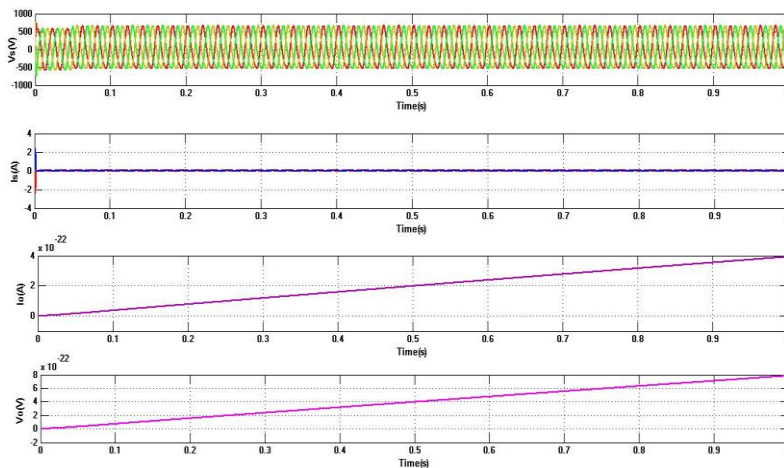

Fig 10: Performance of Proposed Welding Power Supply at 415 V AC Mains to Mitigate injection of 3<sup>rd</sup> Harmonic

**Table 2: Type of injected Harmonics with P.U. magnitude**

S.No.	Combination of harmonics with P.U. magnitude at source end	Value of THD without DVR (%)	Value of THD with DVR (%)
1.	3 <sup>rd</sup> (0.1) & 5 <sup>th</sup> (0.1)	20	0.00
2.	3 <sup>rd</sup> (0.2) & 5 <sup>th</sup> (0.2)	40	0.00
3.	3 <sup>rd</sup> (0.3) & 5 <sup>th</sup> (0.3)	60	0.00
4.	3 <sup>rd</sup> (1/3) & 5 <sup>th</sup> (0.1)	20	0.00
5.	3 <sup>rd</sup> (1/3) & 5 <sup>th</sup> (0.2)	40	0.00
6.	3 <sup>rd</sup> (0.1) & 5 <sup>th</sup> (0.2)	40	0.00
7.	3 <sup>rd</sup> (0.2) & 5 <sup>th</sup> (0.2)	60	0.00

## VII. Conclusions

The performances of Z-source inverter based DVRS for welding load has been analyzed for voltage sag, voltage swell and THD. The proposed method can compensate for most of the voltage faults such as harmonics and any kind of voltage unbalance on the supply networks. The simulation shows that the DVR performance has been satisfactory in mitigating the voltage sags and swells. The main advantage of this DVR is that it is of low cost and its control is simple. It can mitigate long duration voltage sags/swells efficiently. The DVR handles both balanced and unbalanced situations without any difficulties and injects the appropriate voltage component to correct rapidly in the supply voltage to keep the load voltage balanced and constant at the nominal value. By eliminating all harmonics at source side, ZSI has become a cost effective device and the efficiency has also improved. ZSI has no extra voltage stress on power devices. ZSI has been operated in short circuit conditions also which makes the circuit appropriate for welding applications. ZSI has a feature that the ac voltage can be controlled by modulation index. ZSI has enhanced the reliability of system because shoot-through has no longer destroyed the inverter. It has also been observed that the power supply maintains good voltage regulation.

## References

- [1]. Rosli Omar, Nasrudin Abd Rahim and Marizan Sulaiman, "Modeling and Simulation FOR Voltage Sags/Swells Mitigation Using Dynamic Voltage Restorer (DVR)", Journal of Theoretical and Applied Information Technology, pp. 464-470, 2009.
- [2]. Anmol and Parag Nijhawan, "Application of Dynamic Voltage Restorer for Voltage Balancing with ASD Load Using DQO Transformation", International Journal of Electrical Engineering, vol. 4, no. 8, pp. 890-898, 2011.
- [3]. S. H. Laskar and Mohibullah, "Power Quality Issues and Need of Intelligent PQ Monitoring in the Smart Grid Environment", International Journal of Emerging Technology and Advanced Engineering, vol. 2, no. 9, pp. 63-69, 2012.
- [4]. K. Chandrasekaran, P.A. Venkatachalam and Mohd Noh Karsiti, "Dynamic Voltage Restorer As A Sag Mitigator And Harmonic Restorer", IEEE International Conference on Sustainable Energy Technologies, pp 904-909, 2008.
- [5]. Ramanpreet Kaur and Parag Nijhawan, "Simulation And Comparison Of Control Strategies Of DVR For Compensating Volatge Sags", International Journal of Engineering Research & Technology (IJERT), vol. 2, no. 6, pp. 1993-2000, June 2013.
- [6]. F.Z. Peng, "Z-Source Inverter", IEEE Transactions on Industrial Applications, vol. 39, no. 2, pp. 504-510, 2003.
- [7]. Govindaraj and B. Pradeepa, "Simulation Modelling on Switched Inductor Z-Source Inverter based BLDC drive", International Journal of Innovative Research in Electrical, Electronics, Instrumentation and Control Engineering, vol. 2, pp. 776-784, 2014.
- [8]. Parag Nijhawan, R.S. Bhatia, D.K. Jain, "Simulation based performance comparison of different control methods of ZSI feeding industrial drives", International Conference on Electrical and Microelectronics Systems (ICEMS), Miami (USA), 2015.
- [9]. Swati Narula, G. Bhuvanewari and Bhim Singh, "A modular converter for welding power supply with improved power quality", IEEE International Conference on Power Electronic, Drives and Energy System, pp. 1-4.
- [10]. Das, H. Nademi and L. Norum, "A pulse width modulation for reducing switching frequency for modular multilevel converter", International Conference on Power Electronics (IICPE), pp. 1-6, 2011.