Reconstruction of Phase Current of Induction Motor Drive based on DC Link Measurement

Najma Ansari, Nahid Khan, Shital B. Rewatkar

*Department of Electrical Engineering, Anjuman College of Engineering & Technology, India,
nazmaansari@rediffmail.com*

*Department of Electrical Engineering, Anjuman College of Engineering & Technology,
India, nahid.khan0101@gmail.com*

Department of Electrical Engineering, Yashwantrao Chavhan College of Engineering, India

ABSTRACT: *The aim of this paper is the study of speed sensorless control of IM drive by using dc link quantities. The sensorless control method is to determine the appropriate moment when the motor winding should be commutated. This moment is determined by the rotor position. In this type of drive, the limitations of using various sensors for the measurement of rotor speed, stator current & voltages are minimized by estimating these quantities with the help of algorithms. The aim of reconstruction is to achieve the required motor output without exceeding either the short-term or the long-term motor and inverter ratings. These restraints inevitably mean that a number of working currents within the drive must be monitored. All these currents are difficult to measure accurately in the presence of high di/dt and dv/dt switching transients. In a three-phase motor, at least two motor phase currents must be measured. It is difficult to get current sensors with equal gain over a wide range of frequencies, voltages and currents used in a practical inverter. Therefore we are using the stator current reconstruction method to reduce the physical sensors. The input current and voltage signals to the speed estimation algorithm are the reconstructed waveforms of stator current & voltages obtained from the dc link & not directly on the stator side. In this paper, the focus is given on study of DTC and compare its performance with other speed controlling techniques such as scalar and vector control. A current sensor is usually present in the dc link of most drives that is employed for the over current protection. To reconstruct the three phase currents from the dc link, information regarding the inverter switching states is required. The whole studies has been performed in MATLAB/Simulink environment.*

Keywords - *Induction motor, space vector PWM, DTC, sensorless control, reconstruction.*

I. INTRODUCTION

In recent years significant advances have been made on the sensorless control of IM. One of the most well-known methods used for control of AC drives is the Direct Torque Control (DTC) developed by Takahashi in 1984. DTC of IMs is known to have a simple control structure with comparable performance to that of the field-oriented control (FOC) techniques developed by Blaschke in 1972. Unlike FOC methods, DTC techniques require utilization of hysteresis band comparators instead of flux and torque controllers. Direct torque control of induction motors requires an accurate knowledge of the magnitude and angular position of the controlled flux. In DTC, the flux is conventionally obtained from the stator voltage model, using the measured stator voltages and currents. In this paper the complete control methodology of DTC is studied and it is found that sensorless techniques eliminates the use of mechanical sensor, they require the stator current and stator voltage signals as input. All these currents are difficult to measure accurately in the presence of high di/dt and dv/dt switching transients. In a three phase motor at least two motor phase currents must be measured. It is difficult to get current sensors with equal gain over a wide range of frequencies, voltages and currents used in a practical inverter. The problem is exacerbated if the motor windings are not perfectly balanced or if the current sensors have some dc offset. Over last few years, techniques of stator current reconstruction from the dc link current have been suggested in literature which are then used for current regulation. To reconstruct the three phase currents from the dc link, information regarding the inverter switching states is required. During the active states

of inverter current flowing in the dc link is equal to one of the phase currents or it is opposite . In this paper the reconstructed currents are used for current regulation by hysteresis modulation and this reconstruction method is tested on a direct torque controlled induction motor.

II. DIRECT TORQUE CONTROL

Direct torque control (DTC) is a well-known control scheme of induction motor (IM) drives that provides fast and robust control of the IM. DTC has attracted considerable attention as a result of its use as the and Germany around the mid-eighties. The DTC has been implemented using either variable switching frequency or constant sampling techniques[1,2]. Induction motor (IM) drives based on direct torque control (DTC) allow high dynamic performance to be obtained with very simple control schemes. The conventional DTC has two main drawbacks. The first one is the variation of the switching frequency according to the amplitude of the hysteresis bands and the motor operating speed, whereas the second is that the selection of voltage vectors is not optimised inside the flux hysteresis band to give fast torque response, because of the nature of the hysteresis controllers. Basically the DTC technique is similar to FOC technique all power elements are switched based on the electromagnetic state of the motor[1]. This paper proposes a DTC method for IM, which enables fast torque response at constant switching frequency. This is achieved by optimising the selection of the voltage vectors to give maximum rate of torque increase[3]. Due to its simple structure, DTC can be easily integrated with an artificial intelligence control strategy also [2]. The basic block diagram of DTC is shown in figure(1) below.

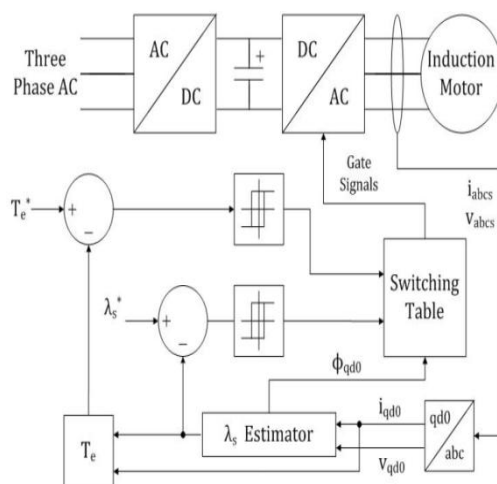

Fig.1. Block Diagram of DTC

III. SENSORLESS CONTROL OF INDUCTION MOTOR DRIVE BASED ON DC LINK MEASUREMENT

The advancement of high performance drives in the recent past years is characterized by continuous increase in dynamics of torque and speed response. In modern industrial applications, even low cost drives have excellent dynamic behaviour which is achieved by field-oriented control combined with high dynamic current regulation. Fundamental to the successful operation of all ac drives is the ability to quickly and accurately

control the motor torque with precise speed/position control, necessitating precise close-loop control of the motor phase currents. They also aim to achieve the required motor output without exceeding either the short-term or the long-term motor and inverter ratings. These restraints inevitably mean that a number of working currents within the drive must be monitored. The feedback for the current control loop can be effectively obtained by sensing the instantaneous currents in at-least two of the motor phases by means of appropriate current sensors. However, more than one current sensor and the associated signal conditioning circuits increase the complexity, the cost and the size of the motor drive. Due to the technical drawbacks discussed above, the reliability of the system reduces. Therefore the reduction in number of sensors is desirable in motor drives. However sensor count reduction should be performed without either affecting the system performance or increasing excessively the hardware complexity.

IV. RECONSTRUCTION OF STATOR VOLTAGES FROM DC LINK VOLTAGES

In a voltage source inverter fed induction motor drive, the dc link voltage is either supplied by a dc voltage source or more usually by an uncontrolled three-phase ac to dc converter with a shunt capacitance on the output side. To reconstruct the three phase stator currents and voltages from dc link quantities, information regarding the inverter switching states is required. The most common three-phase bridge inverter topology made from six switches and six diodes is shown in Fig. 2. It has eight switching states depending upon whether the positive group switches are conducting or not conducting. The switching states are also described as voltage vectors (SA,SB,SC) [3]. They have eight combinations i.e. (0,0,0), (0,0,1), (0,1,0), (0,1,1), (1,0,0), (1,0,1), (1,1,0) and (1,1,1). The vectors (0,0,0) and (1,1,1) are called zero voltage vectors whereas the remaining six are termed as active voltage vectors. The switching signal SA is assigned a value '1' when the positive group switch of leg A is conducting else the assigned value is '0'. Similarly are assigned the values to SB and SC for leg B and leg C respectively.

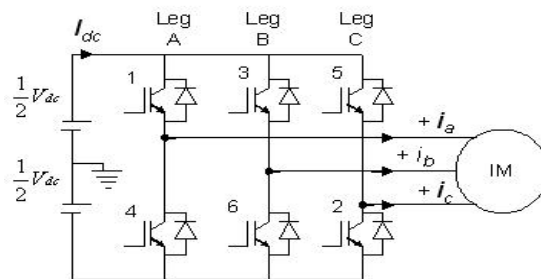
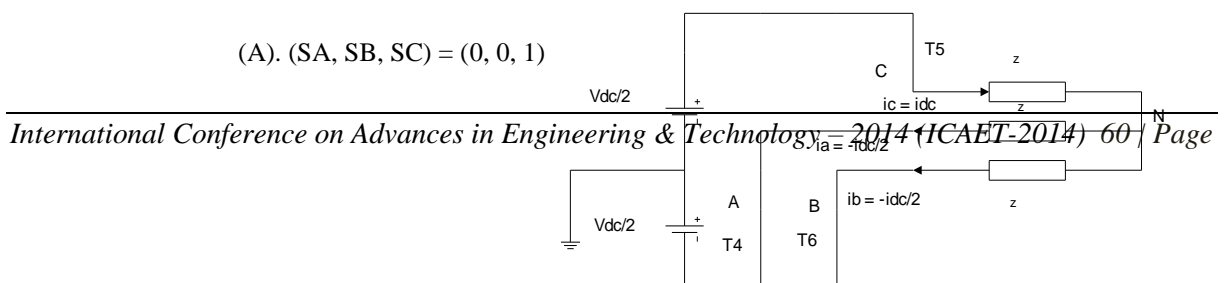

Fig.2. Voltage-source inverter fed induction motor drive

The stator voltages are reconstructed from dc link voltage after understanding the relationship between them during different voltage vectors. This is discussed by using the inverter equivalent circuits as shown below.



The phase voltages are:

$$v_{AN} = -V_{dc}/3$$

$$v_{BN} = -V_{dc}/3$$

$$v_{CN} = 2V_{dc}/3$$

Fig.3. Inverter equivalent circuit at (SA, SB, SC) = (0, 0, 1)

Similarly the other five switching states are calculated with the same method as above.

V. DC LINK CURRENT

The dc link current of a three-phase inverter appears to be a noise superimposed on steady value. Because of the snubber circuit and inductance associated with dc link wires, each time the inverter switching state changes, there exists a transient period over which the dc link current may differ substantially from the phase current. It has been observed that there are both positive and negative spikes on the instantaneous dc link current waveform. It is reported that the negative spikes are caused due to reverse recovery effect of freewheeling diodes during the dead-time period when both switches of the same leg of the inverter are off and the winding currents are flowing through freewheeling diodes of that leg. . The relationship between applied active voltage vectors and the phase currents measured in the dc link is given in Table 1.

Table 1. Voltage vectors and phase currents in the dc link

Voltage vector	0,0,0	0,0,1	0,1,0	0,1,1	1,0,0	1,0,1	1,1,0	1,1,1
Phase current in the dc link	0	ic	ib	-ia	ia	-ib	-ic	0

It is clear that at-most, one phase current can be related to the dc link current at every instant. The reconstruction of phase currents from the dc link currents can be achieved easily only if two active voltage vectors are present for atleast enough time to be sampled. Fortunately as indicated for most PWM strategies, two phase currents can be sampled by looking at the dc link current over every PWM period. Hence a reconstructed current derived from the dc link current gives a reasonable approximation of the actual current. In terms of switching states and I_{dc} , the three ac currents can be derived as follows

$$i_a = I_{dc} \left[S_A - \frac{S_B}{2} - \frac{S_C}{2} \right] \tag{1}$$

$$i_b = I_{dc} \left[-\frac{S_A}{2} + S_B - \frac{S_C}{2} \right] \quad (2)$$

$$i_c = I_{dc} \left[-\frac{S_A}{2} - \frac{S_B}{2} + S_C \right] \quad (3)$$

The reconstruction procedure and its algorithm [11] is used and based on this following simulation results are obtained.

VI. SIMULATION RESULT

Following tests are performed in MATLAB/Simulink software.

Test 1: Free acceleration characteristics

The machine is allowed to accelerate from zero speed to rated speed at no-load. The steady-state was reached at 0.6 s. The reconstructed phase currents is shown in Fig 4. As a measure of drive performance, the instantaneous torque, the instantaneous rotor speed, stator current and the dc bus voltage are also presented in this figure.

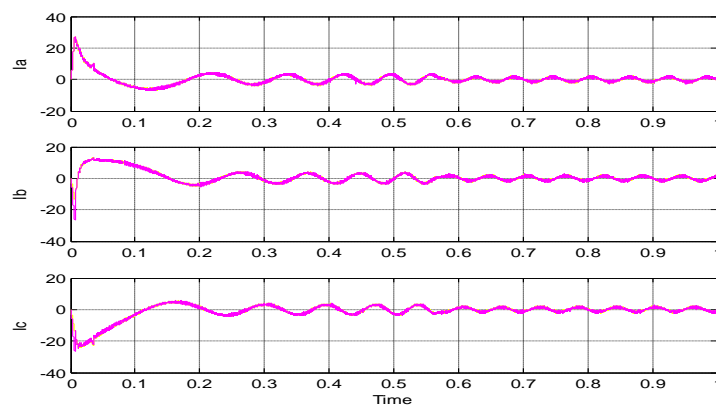

(a)

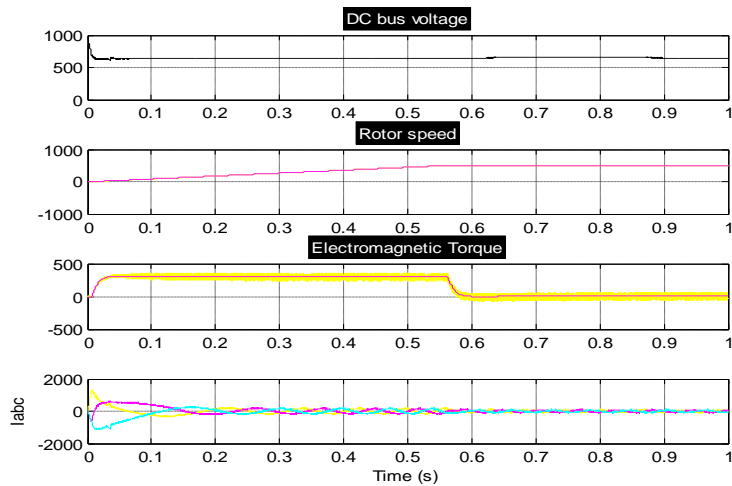

(b)

Fig .4. Simulation results during free acceleration from zero speed at no-load condition (a) reconstructed currents i_a, i_b, i_c in (p.u.), (b) dc link voltage, torque, rotor speed and stator current.

Test 2: Step change in speed reference

With zero load connected to the shaft, step change in speed reference was applied two times. At 0.8 s, from +100% to +20% and vice-versa at 1.5 s was applied. The responses are shown in Fig. 5(a) & (b). The torque turns negative after the first change, to decelerate the motor. Upon reaching steady state, the torque becomes equal to the load torque.

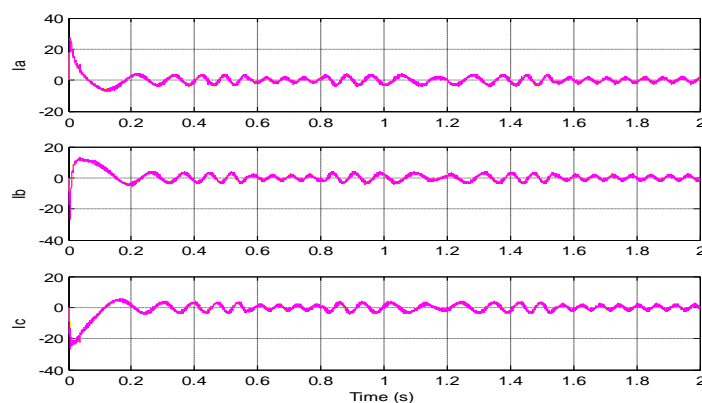

(a)

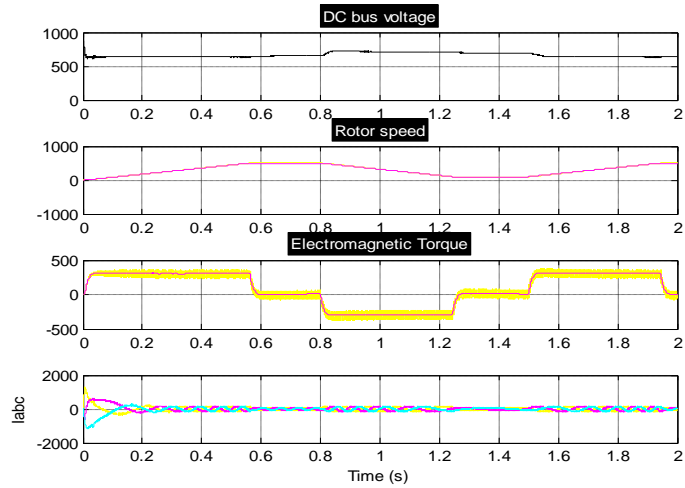

(b)

Fig .5. Simulation results during step change in speed reference at no-load condition (a) reconstructed currents i_a , i_b , i_c in (p.u.), (b) dc link voltage, torque, rotor speed and stator current.

Test 3: Speed reversal

A step change in speed reference from +100% to -100% is applied at 0.8 s. The motor is on no-load condition. This step change is equivalent to 100% speed change. The responses are shown in Fig. 6 (a) & (b). The phase sequence of reconstructed currents gets reversed to rotate the rotor in opposite direction.. This proves the accuracy of the proposed scheme even during 100% speed reversal.

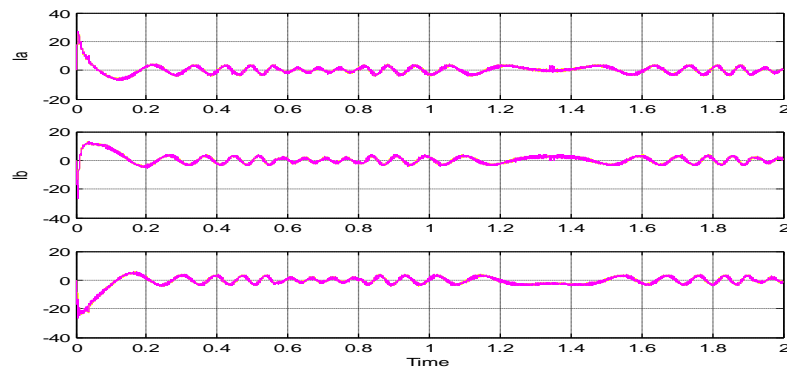

(a)

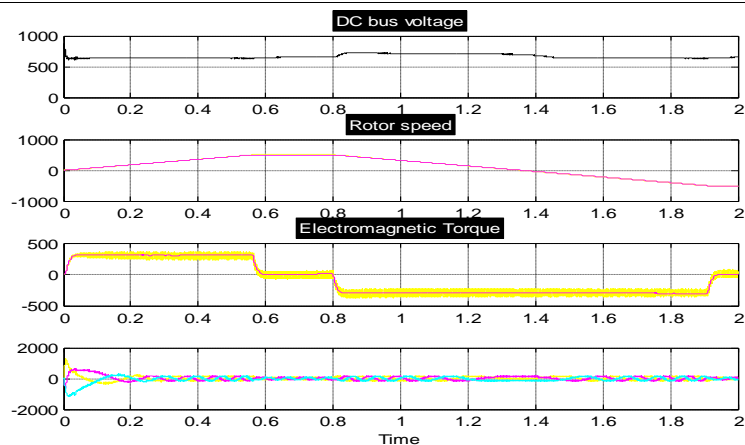

(b)

Fig .6. Simulation results during speed reversal at no-load condition (a) reconstructed currents i_a , i_b , i_c in (p.u.), (b) dc link voltage, torque, rotor speed and stator currents.

VII. CONCLUSION

The proposed Direct Torque Control Technique with the implementation of the DTC model has been deeply studied. The work has been inspired from a model of DTC in MATLAB and then the reconstructed algorithm was included in that particular model. This algorithm is tested on a DTC, IM drive in MATLAB/Simulink environment over a wide range of speed in both the direction while subject to different load conditions. The simulation results prove that the proposed algorithm works accurately at any load from zero to rated value and at any speed in both directions. The feasibility and validity of the developed DTC model, based on switching table technique, have been proved by simulation results obtained in torque control mode.

REFERENCES

- [1] Paul.C.Krause, "Analysis of Electrical Machinery", Mc-Graw-Hill, 1986.
- [2] B.K.Bose, "Morden Power Electronics and AC Drive", Prentice-Hall, 2002.
- [3] Peter Vas , "Sensorless Vector and Direct Torque Control" Published in the United States by Oxford University Press,Inc.,New York,1998.
- [4] Maurizio Cirrincione , Marcello Pucci and Gianpaolo Vitale, "A Novel Direct Torque Control of an Induction Motor Drive with a Three-Level Inverter", IEE Conference on Power Tech, Italy, June 2003.
- [5] F.Khoucha, K.Marouani, K.Aliouane and A. Kheloui, "Experimental Performance Analysis of Adaptive Flux and Speed Observers for Direct Torque Control of Sensorless Induction Motor Drives, IEEE Conference on Power Electronics Specialists, Germany, pp. 2678-2683, 2004.
- [6] D. Casadei, G. Serra, A. Tani, and L. Zarri, "Assessment of direct torque control for induction motor drives", IEEE Trans, Technical Sciences, Vol. 54, No. 3, 2006.
- [7] S. B. Bodkhe and M. V. Aware, "Speed-sensorless, adjustable-speed induction motor drive based on dc link measurement", International Journal of Physical Sciences Vol. 4 (4), pp. 221-232, April, 2009.
- [8] Aleksandar Nikolic and Borislav Jeftenic, "Different Methods for Direct Torque Control of Induction Motor Fed From Current Source Inverter", WSEAS Trans on Circuits and Systems, Belgrade Serbia, 2008.
- [9] S.A.Zaid, O.A. Mahgoub and K.A. El-Metwalli, " Implementation of a new fast direct torque control algorithm for induction motor drives", IET Electr. Power Appl., 2010 vol. 4, Iss. 5, pp. 305-313.
- [10] Naceri Farid, Belkacem Sebtii, Kercha Mebaraka and Benmokrane Tayeb, " Performance Analysis of Field-Oriented Control and Direct Torque Control for Sensorless Induction Motor Drives", IEEE Conference on Control and Automation, July 2007, pp. T21-002.
- [11] S. B. Bodkhe and M. V. Aware, " Reconstruction of Phase Currents from DC Link in a single-sensor Induction Motor Drive using New Algorithm", International Journal of Modelling and Simulation, vol. 31, No. 1, 2011, pp. 42-53.