

## **Increasing Throughput Efficiency of Ad-hoc Cognitive Radio Networks Using Neural Network Techniques**

<sup>\*1</sup> R. Aruna Devi, <sup>#2</sup> S. Simonthomas, <sup>\*3</sup> D. Karthikeyan

*PG Students*

*Department of Computer Science and Engineering,*

*Dhanalakshmi Srinivasan College of Engineering and Technology, Mamallapuram.*

*UG student, Department of Electronics and Communication Engineering, Asan Memorial College of Engineering and Technology, Chengalpattu.*

---

**Abstract:** *Cognitive radio refers to an intelligent radio, which has the ability to sense the external environment, learn from history and make intelligent decisions to adjust its transmission parameters according to the current state of the wireless channel. Spectrum sensing is an important aspect in the implementation of cognitive radios. The efficiency of spectrum sensing is largely impacted by the interferences in the primary channel. In this paper, a mathematical model for these interferences is first developed and a highly Sophisticated adaptive resonance theory based neural network technique is proposed to Mitigate the effect of such interferences. Additionally it is to be noted that the spectrum Sensing duration and the data transmission duration also have a significant impact on the Throughput of the cognitive network. So, in the latter part of the work, a novel back propagation neural network based throughput maximization technique is proposed and its efficiency is tested by simulations.*

**Keywords:** *Cognitive Radio, Interference, Spectrum Sensing, Throughput, Neural network.*

---

### **I. Introduction**

The increased demand for higher capacities and ubiquitous connectivity, availability of mobile devices with improved technological capabilities and the claim by FCC on the radio spectrum being grossly under-utilized (J. Neel et al,2004), has resulted in a flood of research activities in the area of Cognitive Radios since its introduction in 1999 by Mitola. Cognitive radio is viewed as a novel approach for Throughput Enhancement of Adhoc Cognitive Radio Networks Using Neural Network Techniques 367 improving the effective utilization of the supposedly scarce electromagnetic spectrum. Dynamic Spectrum Access (DSA) refers to communication techniques that intelligently exploit the dynamically changing spectrum holes and thus providing an approach for relieving the capacity bottlenecks of future wireless networks. This is also referred to as opportunistic spectrum access. In a sense cognitive radios may be thought of as a means by which efficient bandwidth harvesting is done, due to its capability to use or share the spectrum in an opportunistic manner. This is the key enabling technology for dynamic spectrum access (Hang su and Xi Zhang,2008).

The optimized usage of the radio network itself is seen as an additional requirement over and above the efficient utilization of spectrum for realizing high capacity, ubiquitous wireless access, (Bogatinovski and Gavrilovska.,2008).Cross-layer design and optimization hence has to be considered hand-in-hand with opportunistic spectrum access to optimize the radio network usage. This paper addresses the issue of effective spectrum sensing and utilization for network optimization. Accurate recognition of availability of radio resource i.e the frequency spectrum is essential to set up an optimal wireless system (Shoji and Shinichi,2008). Also to obtain a stable throughput for a cognitive network, optimal primary detection is essential (Gambini et al.,2007). Opportunistic unlicensed access to the (temporarily) unused frequency bands across the licensed radio spectrum is currently being investigated as a means to increase the efficiency of spectrum usage (Amir Ghasemi and Elvino,2008).

The rest of the paper is organized as follows. Section 2 describes the system model and basic assumptions made and the cross-layer based MAC protocol considered. The throughput analysis is carried out in Section 3. The idle channel sensing accuracy improvement with primary power control is addressed in Section 4 and the throughput enhancement by primary channel idle time prediction is presented in Section 5. The results of simulation studies carried out are presented and discussed in Section 6 and the conclusions are presented in Section 7.

### **II. Cross Layer-Based Mac Protocol**

The system model considered in this work assumes the locations of the primary and the secondary users to be following a poisson and uniform distributions respectively. A separate control channel in the form of a small chunk of the frequency spectrum is assumed to be available for negotiating white space spectrum usage

among the secondary users. Alternately UWB could be used as a common control channel providing the added advantage of node localization, which can be used for MAC and Routing functions(AAF report,2005). Within the given area, the primary users are assumed to be detectable by the secondary users. Every secondary user is assumed to have cognitive capabilities i.e. has two transceivers namely, the data transceiver and the control transceiver (Hang Su and Zhang,2007).

The primary channel at any given time slot can be either busy (ON) or idle (OFF). Considering these two states for the primary channel status, the transition phenomenon between these two states is modelled as a Markov process (Raghul et al,2009).The primary channel may thus be viewed as an ON/OFF source. The simple energy detection technique is considered for spectrum sensing. At any sensing instant, a primary users' channel may consist of noise alone (inclusive of other interferences and fading) viewed as the OFF state 'or' the signal plus the noise, viewed as the ON state,(Ying-Chang et al,2008). For the purpose of effective spectrum sensing, two spectrum sensing schemes or policies namely, the Random Sensing Policy (RSP) and the Negotiation-Based Sensing Policy (NSP) are considered(Hang su and Xi Zhang,2008) in this work. A parameter called the 'primary channel utilization factor' is defined, as ratio of the average number of licensed channels currently in use by the primary users to the total done at the physical layer while packet scheduling on spectral holes identified is done at the MAC layer; hence the name 'cross-layer based MAC protocol'(Akyildiz et al,2006).

A cross-layer based time-slotted MAC protocol(Hang su and Xi Zhang,2008) is considered in this work. Each slot in the frame consists of sensing/ reporting phase and a contending phase. The sensing and reporting phase consists a number of mini-slots corresponding to the primary licensed channel bands, as seen in Figure 1.

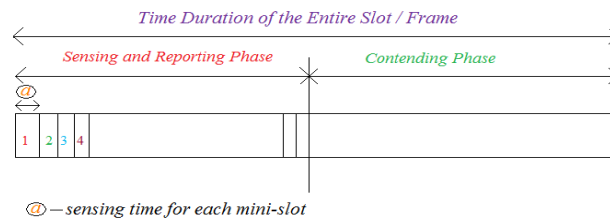

Fig 1: Illustration of spectrum sensing in minislots

Since sensing and reporting of the channel status are carried out simultaneously in a pipelined manner in this protocol, too much of time is not wasted in sensing and reporting thereafter (Feng Gaoet a.,2009).This is an inherent advantage of this time-slotted MAC protocol.

### III. Throughput Analysis

In this work the throughput of the cognitive radio network is defined as the the total number of packets received in a timeslot at the data rate 'R'. Then the throughput realized by the cognitive network is dependent on the number of primary channels perceived as unused by the secondary users, say L and the data rate R. The time duration, TCP, corresponds to the time available for secondary users to transmit their data through the primary channel opportunistically acquired by them. Assuming the contending phase to be saturated with secondary user traffic, the throughput is also proportional to the ratio of the contending phase (TCP) to the duration of the entire time slot (TS). The throughput of the cognitive network is therefore given by,

$$T = \frac{L * R * T_{CP}}{T_S}$$

The sensing policy determines the number of unused primary channels as perceived by the secondary users, LRSP in case of RSP and LNSP in case of NSP.

The derivation in Equation assumes that all the secondary users always sense the idle channels correctly. This simply means that they sense the busy channels to be busy and idle channels to be idle. But under realistic situations, this may not be true due to fading effects and interferences in the wireless medium. These interferences may reduce the Signal-to-Noise Ratio (SNR) of the primary channel which in turn may affect the sensing of signal presence on this channel. In other words, if a primary user link has a poor SNR due to another primary user's interference or a cognitive user's interference, the cognitive users may wrongly sense the particular channel to be in the idle state and try to use it for their transmission. This would now affect the entire primary-secondary users' network and the whole system would gradually collapse failing to meet QoS requirements.

Consider that secondary users see a Rayleigh fading channel and the locations of the primary users are assumed to follow Poisson distribution and that of the interferers follow uniform distribution. The

characteristic function of the interference and hence the aggregate interference power of the primary users' seen by a reference primary user 'i' is obtained as(Haythem et al.,2009), the variance (power), denoted using the notation sigma.

$$\sigma_{P_{PR-PR}}^{(i)} = [\pi\gamma_i\rho_i/3][2P_0 d_0^{(i)} \exp(-\pi\gamma_i\rho_i(b_i)^2)]^2 (b_i/d_0^{(i)})^{-6}$$

Throughput Enhancement of Adhoc Cognitive Radio Networks Using Neural Network Techniques. where  $\gamma_i$  is the channel utilization of the specific primary user,  $\rho_i$  is the mean of the Poisson process,  $P_0$  is the pathloss at the close-in-reference distance  $d_0$  between a primary transmitter and the primary receiver and  $b_i$  is the minimum allowable distance between the primary users(Haythem et al.,2009). Similarly, the power of the aggregate interference caused by the cognitive users to a primary user 'i' is given by,

$$\sigma_{P_{CR-PR}}^{(i)} = [\pi\gamma_i\rho_i/3][2P_0 d_0^{(i)} \exp(-\pi\gamma_i\rho_i(b_i)^2)]^2$$

The total interference power including some background noise 'N' at the reference primary receiver is given as,

$$\sigma_{total} = \sigma_{P_{PR-PR}}^{(i)} + \sigma_{P_{CR-PR}}^{(i)} + N$$

The signal power at the primary receiver is given as,

$$S = \delta |h(t)|^2 P_p$$

where  $\delta$  is the average channel power gain,  $h(t)$  is the channel impulse response and  $P_p$  is the normalized transmit power of the primary user (Osvaldo et al.,2007).The SINR ratio of the reference primary channel is therefore given by,

$$\Psi = \frac{S}{\sigma_{total}}$$

When the value of ' $\psi$ ' becomes less than the detection threshold value,  $\Phi$ , error occurs in the sensing process. In such a scenario, the probability of correct sensing,  $P_c$ , is given as,

$$P_c = P(\Psi > \Phi) = e^{-\frac{\Phi}{\delta}}$$

The throughput in equation (1) now gets modified to equation (8) by considering the above interference analysis.

$$T_{(int f)} = (P_c) * T$$

The throughput obtained in (8) taking the impact of interferences and channel fading is a more realistic value that can be actually achieved.

#### IV. Primary Power Control

The throughput analysis carried out in the previous section shows the negative impact of interference on channel sensing accuracy and throughput. So interference mitigation/ power control becomes an essential component to improve throughput. Interference mitigation techniques could be implemented on the secondary network to reduce the corresponding secondary user interference or could be incorporated on the primary network or both. In this work the primary channel sensing accuracy is improved by a power control/interference mitigation technique proposed based on primary network cooperation. The Adaptive Resonance Theory based neural network (NN) ART2 is used here to classify the primary channel as good or bad based on the channel statistics observed over six previous time slots. So there are six neurons in the input layer. Now based on this classification of the nature of the channel, a one bit information is included in the RTS packet of the primary user (transmitting node), indicating whether the channel is good or bad. When the intended primary receiver receives this packet, if it finds that the channel to be used is indicated as bad then it transmits the data at a higher power level. Thus, the communication link between the primary users is stabilized thereby minimizing the chances of erroneous spectrum sensing by the secondary users.

ART2 network is essentially a data classifier, especially for continuous input patterns. It has the advantage of overcoming the problem of stability-plasticity dilemma due to the presence of two weight matrices 'top-up,  $t_{ij}$ ' ( $tw$ ) and 'bottom down,  $b_{ij}$ ' ( $bw$ ) (Patil.B.M et al.,2006), (Sivanandam.S.N et al.,2005).Fig.2 shows the architecture model of the ART2 network used for the channel classification purpose. The input layer,  $S_i$ , comprises of six input neurons and the output layer,  $C_i$ 's consists of two output neurons.  $R_i$  is the reset block,

that performs the vigilance test, which makes the network a stable one when presented with irrelevant inputs while being plastic to correct or relevant inputs. A, B and C are constants.  $P_i$ ,  $Q_i$ ,  $U_i$ ,  $V_i$ ,  $W_i$  and  $X_i$  are the hidden units of the network. The activation function ‘f’ used is,

$$f(x) = \begin{cases} x, & \text{if } x \geq \theta \\ 0, & \text{if } x < \theta \end{cases},$$

where in,  $\theta$  is noise suppression parameter.

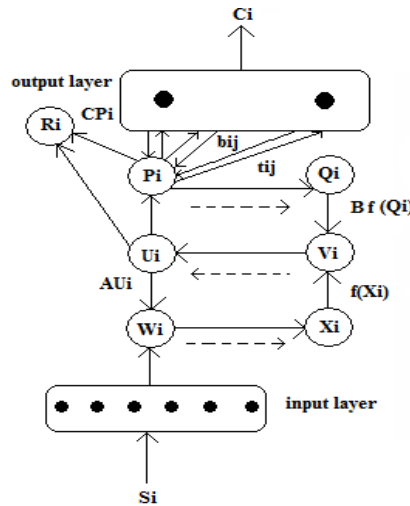

Fig 2 : ART2 Architecture

At the onset of training, the two weight matrices are initialized. Upon training the network, after certain number of epochs they become transpose of each other. Now the NN is said to have converged or trained to classify the data when presented with relevant set of testing inputs. Now, using these weight matrices the neural network output is found out by presenting it with a set of six input values similar to those used for training (but not the same used for training). A channel can be classified either as good or bad; hence there are two neurons at the output layer of the neural network corresponding to each one of the plausible outputs. Thus, by appropriately adjusting the power levels of the primary users using this approach, the SNR of their communication links is maintained high which would in turn result in highly accurate sensing process and hence yield a stable throughput.

Therefore, using primary power control to reduce link impairment due to interference, the improved probability of correct sensing obtained is denoted as  $P_c$  ( $int f_{mit}$ ), and the throughput equation would now be

$$T_{(int f_{mit})} = P_{c(int f_{mit})} * T_{(int f)}$$

This equation represents the throughput that can be achieved using this power control technique. The backbone of this algorithm is the power information bit. The neural network’s (ART2) classification accuracy is hence significant under this analysis as the value of this bit (0/1) is decided based on this classification accuracy. Besides being computationally efficient, the classifier must operate reliably. Therefore a simple self-confidence analysis is proposed for the classifier which makes use of the continuous output of the ART2 network. The performance of the neural network classifier is separated into two hypotheses as follows,

H4.0 – channel is classified correctly

H4.1 – channel is classified incorrectly

ART2 operates on a single decision statistic, that is, it gives its output which leads to a single, final decision out of the total two choices available about the nature of the channel (being either bad or good). So, a reliability parameter,  $\chi$ , is defined as,

$$\chi = (C_m - \arg \max(C_k)_{k \neq m}) / 2$$

which is half the distance from the largest ART2 output,  $C_m$ , to its closest competitor, ‘k’. Since there are only two neurons at the output layer of ART2, the value of the parameter,  $\chi$ , takes a value one in most cases, indicating a perfectly reliable situation (Fehske et al.,2005).

### V. Throughput Maximization

The basic idea here is to maximize the throughput of the cognitive network by significantly increasing the data transmission time for the secondary users. This is done based on the time series prediction technique using the back propagation neural network (Refenes et al.,1992).If spectrum sensing is carried out very frequently there is wastage of time unnecessarily.

On the other hand, if it is done infrequently, some spectrum opportunities might be missed out (Jun Ma and Ye Li,2008),Yiyang et al.,2007). So, based on the history of the primary channel status transition, using the back propagation neural network procedure, the time duration for which the primary channel could remain idle, once the secondary user has acquired it for data transmission, is predicted, and for these number of time slots that particular primary channel is not sensed. This results in a corresponding increase in the duration of the contending phase or the data transmission time for the secondary users and hence the throughput of the cognitive network improves. A model of the backpropagation neural network used is shown in Fig.3.  $U_{ij}$  and  $V_{jk}$  are the weight matrices connecting the input, and the hidden layer and the hidden and the output layer respectively.

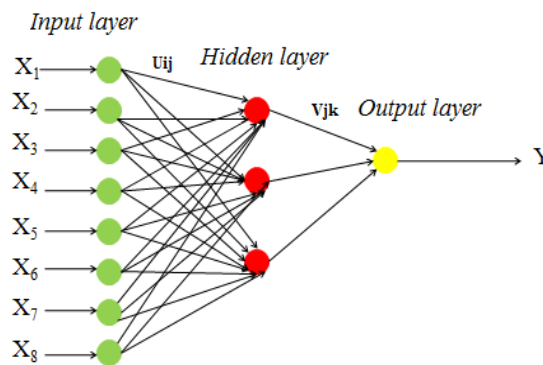

Fig 3: Back propagation neural network

### VI. Results And Discussion

The above mentioned approaches to improve throughput are verified by simulations carried out in ANN.. The simulation set-up consists of ten primary users and the secondary users are varied from two through twenty in steps of two. Both the Random Sensing Policy and The Negotiation-Based Sensing Policy are compared in terms of the throughput for a scenario wherein the primary user channel utilization factor is 0.6, that is, out of the ten licensed channels available, six are currently being used by the primary users. The available channels and their usage time have been modeled using a similar analysis as in (Xiangwei et al.,2009).The number of primary channels perceived as unused by the secondary users is determined using RSP and NSP, as LRSP and LNSP respectively.

The throughputs obtained for the secondary users under RSP and NSP is shown in Fig.4 and Fig.5 respectively. The throughput obtained without interference / channel fading considerations, throughput considering interference / channel fading effects and the throughput with primary network power control implementation are compared in both cases. It is observed that in the absence of interference / channel fading considerations, the throughput obtained is an overestimate since channel sensing is assumed to be perfect and the secondary users get a false notion of having achieved a much higher throughput than the value that can be actually achieved. When interference / channel fading effects are accounted for during sensing it is noted that the throughput reduces drastically but is a more realistic value. Implementing the primary power control technique using the ART2 neural network, it is observed that the throughput is marginally reduced. The accuracy of the sensing process is improved and hence the probability of correct sensing also increases. However the number of channels which were falsely sensed as idle in the absence of power control are now correctly sensed to be busy. This reduces the value of  $L$  that can be used by the secondary network. Hence the throughput improvement expected with improved probability of correct sensing is offset by the number of idle channels available for use and so there is a reduction in throughput. But this depicts a more realistic scenario.

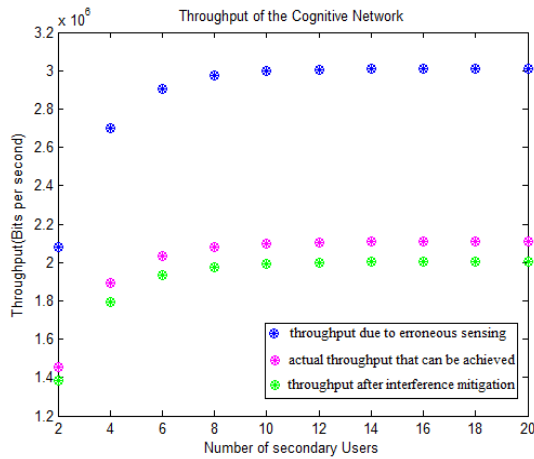

Fig 4: Throughput comparison under Random Sensing Policy

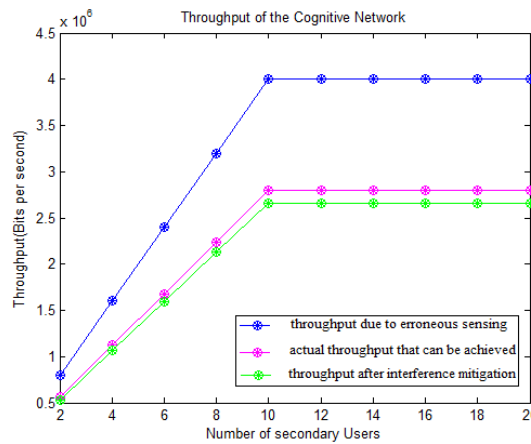

Fig 5: Throughput under Negotiation-based Sensing Policy

The prediction based spectrum sensing is then employed and throughput compared with that of the conventional periodic spectrum sensing. The input time series vector consists of eight values that denote ‘for how many time slots, previously, for a given observation time, the specific primary channel was free’. Based on this input and approximate target values, the time duration (in microseconds) for which the channel will be free, once the secondary user starts transmitting over that channel, is found out. For these numbers of time slots, this specific channel need not be sensed. Fig.6. illustrates the convergence of the back propagation algorithm during its training phase. Once it gets appropriately trained, it gives the correct output. In the hidden layers the main operation that takes place is the autocorrelation analysis of the input time series that is very vital for predicting or forecasting the required value (Feng Lin et al.,1995).

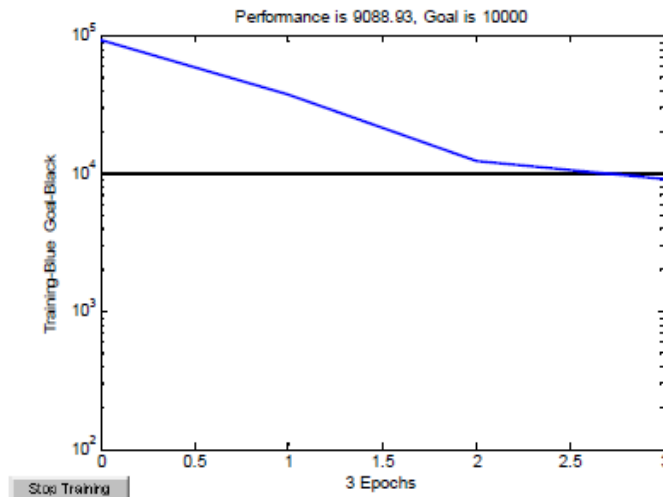

Fig 6 : Convergence of the back propagation neural network during training, towards the goal

The throughputs obtained with prediction based spectrum sensing and that of the conventional periodic spectrum sensing are compared for RSP and NSP and shown in Fig.7 and Fig.8, respectively. It is observed that the throughput can be significantly improved by using the neural network based idle time prediction technique under both the sensing policies.

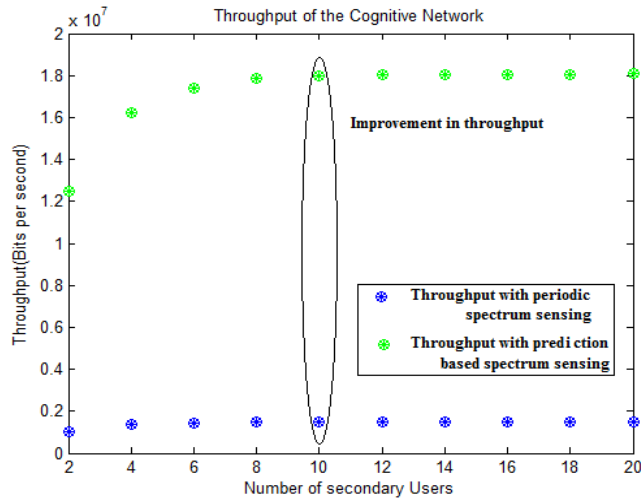

Fig 7: Throughput improvement by idle time prediction under Random Sensing Policy

In this scheme, if two mobile nodes are moving away from each other, both of them have to progressively increase their transmission range in order to protect the link between them to ensure connectivity.

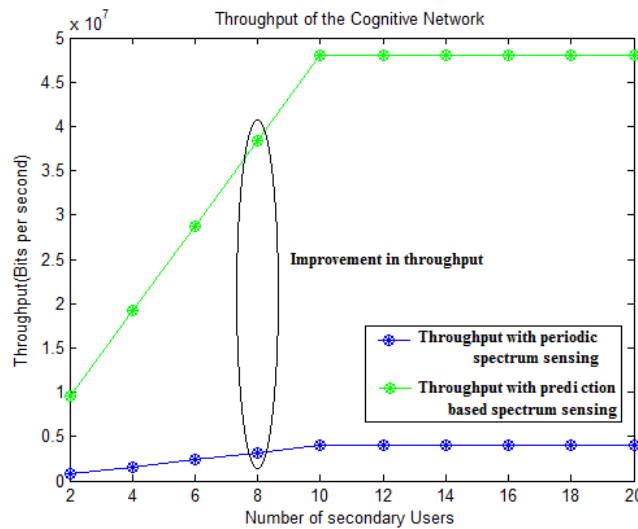

Fig 8: Throughput improvement by idle time prediction under Negotiation-based Sensing Policy

Thus, the neural network based power control technique and the time prediction based spectrum sensing mechanism help in stabilizing and improving the throughput of the cognitive network.

### VII. Conclusion And Future Work

The throughput analysis carried out in this work suggests that the channel sensing accuracy can be improved with the primary network power control. With accurate channel sensing the realistic throughput achieved by secondary network is reduced. However it is also shown that improvement in throughput can be realized by making an accurate prediction of the time for which a primary channel may be idle based on past record. Accurate channel sensing by primary power control has the drawback that it requires the primary users' cooperation for incorporating the neural network module in their existing systems. The delay involved in the decision making process also needs to be analysed and compared with existing power control mechanisms if any. Synchronization issues also need to be analysed when prediction based idle time probabilistic spectrum sensing is employed. Future work would address the improvement of the suggested techniques considering the above issues without either disturbing the primary network or introducing much complexity in the spectrum sensing/implementation issues.

### **Biography**

**R. ArunaDevi** - Doing post graduate in computer science department in Dhanalakshmi srinivasan college of Engineering and Technology, Mamallapuram. Published many papers in journals and presented network related papers in various conferences.

**S. Simonthomas** - Completed Bachelor of Information Technology in Alpha College of Engineering, Thirumazhisai. and now pursuing post graduate in Computer Science department. He doing research work under Image processing and networks.

**D. Karthikeyan** - Bachelor of Electronics and Communication Engineering in Asan memorial college of Engineering and Technology, Chengalpattu. Completed his project under communication networks. Aim is to achieve research works in management studies.

### **References**

- [1] Vanessa Ann Davies, Evaluating Mobility Models Within An Ad Hoc Network. A Master's Thesis, Golden, Colorado, 2000.
- [2] Bakin, D., Evolution of 802.11 (physical layer)
- [3] 802.11a Standard, <http://standards.ieee.org/catalog/olis/lanman.html>
- [4] Taub & Schilling, Principles Of Communication System, TMH, 2004.
- [5] Bhattacharya, P. P., A Novel Opportunistic Spectrum Access For Applications In Cognitive Radio
- [6] Ian F. Akyildiz, Won-Yeol Lee, Mehmet C. Vuran, Shantidev Mohanty, Next Generation/dynamic spectrum access/cognitive radio wireless networks: A survey, Computer Networks, 2006
- [7] Amir Ghasemi, Elvino S. Sousa, April 2008, "Spectrum Sensing In Cognitive Radio Networks: Requirements, Challenges And Design Trade-Offs", *IEEE Commun. Mag.*, vol. 46, no. 4, pp.32—39.
- [8] Bogatinovski.M, and L. Gavrilovska, 2008 "Overview of Cross-Layer Optimization Methodologies for Cognitive Radio", 16th Telecommunications Forum TELFOR, pp. 254 – 257.
- [9] Feng Gao, Wei Yuan, Wei Liu, Wenqing Cheng, and, Shu Wang ,2009, " Pipelined Cooperative Spectrum Sensing in Cognitive Radio Networks", IEEE Communications Society, WCNC 2009 Proceedings.
- [10] Fehske.A, J. Gaeddert, and J. H. Reed ,2005 , " A New Approach to Signal Classification Using Spectral Correlation and Neural Networks", 1st IEEE International Symposium on New Frontiers in Dynamic Spectrum Access Networks, DySPAN 2005, pp 144-150.
- [11] Freeband AAF Project Report, 2005 "Protocol Requirements for Cognitive Radio Networks", Technical University, Delft, Version 0.4.
- [12] Feng Lin, Xing Huo Yu, Shirley Gregor and Richard Irons, 1995 " Time Series Forecasting with Neural Networks", Complexity International, vol.02.
- [13] Gambini.J, O. Simeone, U. Spagnolini and Y. Bar-Ness, 2007, " Cooperative Cognitive Radios With Optimal Primary Detection And Packet Acceptance Control", IEEE proceedings, Signal Processing Advances in Wireless Communication, 2007, SPAWC, 2007, IEEE 8th Workshop.
- [14] Hang Su , and Xi Zhang, Jan 2008 " Cross-Layer Based Opportunistic MAC Protocols for QoS Provisionings Over Cognitive Radio Wireless Networks.", *IEEE Journal on Selected Areas in Communications*, vol.26, no.1, pp 118-129.
- [15] Hang Su and X.Zhang, March 2007, " Opportunistic MAC protocols for cognitive Radio based wireless networks.", *Proc. 41st Conference on Information Sciences and Systems (CISS 2007)*, John Hopkins University.
- [16] Haythem Bany Salameh, Marwan Krunz ,and Ossama Younis, Oct 2009, " MAC Protocol for Opportunistic Cognitive Radio Networks with Soft Guarantees" *IEEE Transactions on Mobile Computing*, vol.8, no.10, pp 1339-1352.
- [17] Jun Ma and Ye (Geoffrey) Li, 2008, " A Probability-based Spectrum Sensing Scheme for Cognitive Radio", *IEEE Communications Society, ICC 2008 Proceedings*, pp3416-3420.
- [18] Mitola.J III, 1999 "Cognitive Radio for Flexible Mobile Multimedia Communications," Proc. IEEE MOMUC '99, San Diego, CA, Nov. 15–17.
- [19] Neel.J, J.H. Reed, R.P. Gilles, 2004. "Convergence of Cognitive Radio Networks," *Proceedings of Wireless Communications and Networking Conference* ,Aug 2004.
- [20] Osvaldo Simeone, Yeheskel Bar-Ness, and Umberto Spagnolini, December 2007 " Stable Throughput of Cognitive Radios with and without Relaying Capability.", *IEEE Transactions on Communications*, vol.55, no.12, pp 2351-2360.