

Research on Absorption Refrigeration by Solar Powered Vapour

Rahul Prajapati¹, Kailash Mohapatra²

¹(Department of Mechanical Engineering, Gandhi Engineering College, India)

²(Department of Mechanical Engineering, Gandhi Institute For Technology, India)

Abstract: Vapor absorption refrigeration has a place with the class of Vapor cycles like Vapor pressure refrigeration cycle. Contribution for fume ingestion framework is as warmth subsequently these frameworks are additionally called as thermal worked frameworks. Since the fluids are utilized to retain the refrigerants, they additionally called as wet absorption framework. So these framework runs on second rate vitality, they arranged when poor quality vitality, for example, squander heat or sun oriented vitality is accessible. So from all the perspective, for example, natural cordial, cost and effectively accessible vitality. Work has been done to check the presentation like Cop and Circulation proportion utilizing sun oriented based framework to watch the factors like stream rate and creation.

I. Introduction

Vapor Absorption Refrigeration Systems (VARS) belong to the class of vapor cycles like vapor compression refrigeration systems. However, unlike vapor compression refrigeration systems, the required input to absorption systems is in the form of heat. Hence these systems are also called as heat operated or thermal energy driven systems. Since conventional absorption systems use liquids for absorption of refrigerant, these are also sometimes called as wet absorption systems.

Like vapor compression refrigeration systems, vapor absorption refrigeration systems have also been commercialized and are widely used in various refrigeration and air conditioning applications. Since these systems run on low-grade thermal energy, they are preferred when low-grade energy such as waste heat or solar energy is available. Since conventional absorption systems use natural refrigerants such as water or ammonia they are environment friendly.

Since the beginning of the last century, average global temperature has risen about 0.6 K per UN Intergovernmental panel on climate change. It is also warned that the temperature may further increase by 1.4-4.5 K until 2100. Having realized the seriousness of the situation, the world community decided to take the initiatives to stop the process. One of such effort is the Kyoto protocol, a legally binding agreement under which industrialized countries will reduce their collective emission of greenhouse gases by 5.2% compared to the year 1990. Especially regarding the reduction of carbon dioxide, being the inevitable by-product of industrial activities, industries should improve facilities and processes to achieve the goals. Refrigeration industry is one of those hardest hits by the effect of the protocol.

In Europe, use of HFC134a will be banned for the air conditioning units in new cars. Inspection and monitoring are required for all stationary HFC based refrigeration, air conditioning and heat pump units for the safe containment of HFCs. Reduction of energy consumption for refrigeration, however, cannot be relied solely on the improvement of efficiency. Reduction in use of synthetic refrigerants and production of CO₂ provide a new opportunity for solar refrigeration. Considering cooling demand increases with intensity of solar radiation, solar refrigeration has been considered as a logical solution. In the 1970s-solar refrigeration received great interests when the world suffered from oil crisis. There were many projects for the development of solar refrigeration technologies and solar refrigeration continued to be an important issue.

A variety of solar refrigeration technologies have been developed and many of them are available in the market at much cheaper prices than ever.[1] Solar energy is very large inexhaustible source of energy. The power from the sun intercepted by the earth is approximately 1.8×10^{11} MW which is much larger than the present consumption rate on the earth of all commercial energy sources. Thus, solar energy could supply all the present and future energy needs of the world on the continuing basis.

Flat plate collectors

Flat plate collector is an insulated weather proofed box

Containing a dark absorber plate under one or more



Parts of a Flat Plate Collector:

Cover Plate: It is made up of glass tempered with a low iron Content and 3.2-6.4 mm thick. The collector has 85% transmittance when this type of glass is used. **Absorber Plate:** It is made up of copper because of its high conductivity. Moreover, it is corrosion resistant. These copper plates 0.05 mm thick with 1.25 cm tubes. Tubes are Spaced 15 cm apart, the efficiency is 97 %. Moreover, black paint over copper plate is used which has Absorbance =0.85-0.9 and emittance=0.08-0.12.

Enclosure/Insulation: It is made up of steel, aluminum or fiber glass. Fiber glass is widely used.

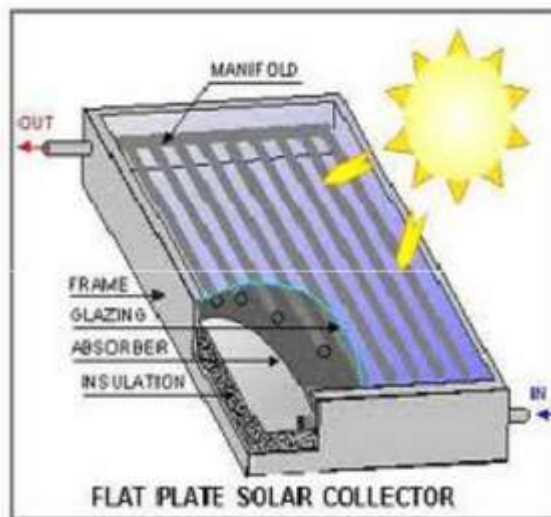
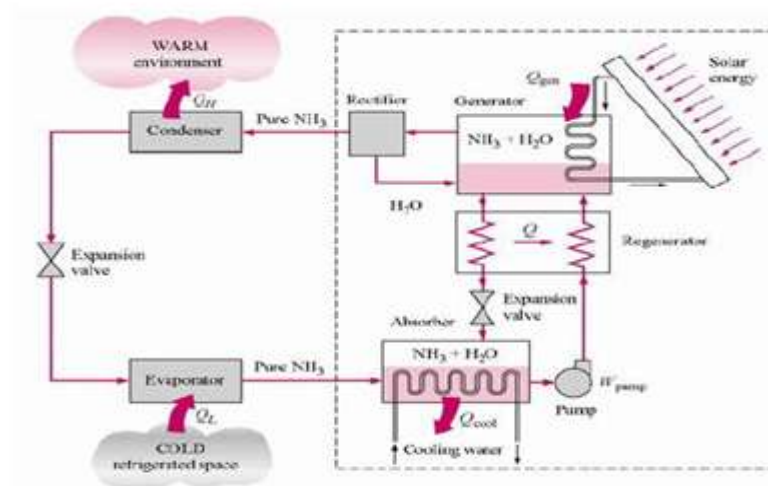

Figure 2 Flat plate collector parts

$$COP_c = \frac{\text{Desired output}}{\text{Required input}} = \frac{\text{Cooling effect}}{\text{Work input}} = \frac{Q_c}{Q_{gen} + W_{pump}} = \frac{Q_c}{Q_{gen}}$$



II. Mathematical Modeling

The operating pressures at which the system is working needs to be determined to carry on further calculations, using an enthalpy concentration chart. Once the pressure of the condenser (P_c) and the pressure of the evaporator (P_e) are determined the corresponding points can be fixed on the chart as shown in fig. 4. The various other points and condition lines for components like absorber, generator, heat exchangers etc can be subsequently fixed.

2.1. Condenser Pressure (P_c)

The pressure to be maintained in the condenser for changing the phase of ammonia vapors into ammonia liquid depends on type of condensing medium used and its Temperature.

In this system, water is used as a condensing medium. Water is available at a temperature of 25 °C. i.e. condensing temperature is $T_c = 25$ °C. For condensing ammonia vapors at 25°C, the corresponding pressure required can be noted from the refrigeration table of ammonia (R-717).

2.2. Evaporator Pressure (P_e)

The evaporator pressure can be fixed per the minimum temperature required to be maintained in the evaporator chamber. The minimum temperature attained is not a designing criterion in this system, as we require to cool water only for drinking purposes. The pressure maintained in the evaporator should be as close to the atmospheric pressure as possible, because maintaining a higher pressure is a difficult and costly affair. Moreover, it also has leakage problems and the unit needs to be hermetically sealed. The evaporator pressure is kept equal to the atmospheric pressure (1 bar), to ensure design economy. The corresponding saturation temperature in the evaporator (ammonia vapors) becomes -33 °C.

2.3. Absorber

In absorber, the pure NH_3 gas enters at condition 4 and Weak aqua solution enters at condition 10 and after mixing, strong aqua comes out at condition 5. The mixing occurring inside is underlined but aqua condition coming out is known. Join the points 10 and 4 and extend the vertical line passing through point 7 till it cuts at point 7". Now we can say that mixing taking place along the line 4-10 and at pressure P_e and resulting aqua is coming out at 5 after losing heat in the absorber. Joining the points 4 and 10 and marking point 7" is not necessary for solving the Problems or designing the system components.

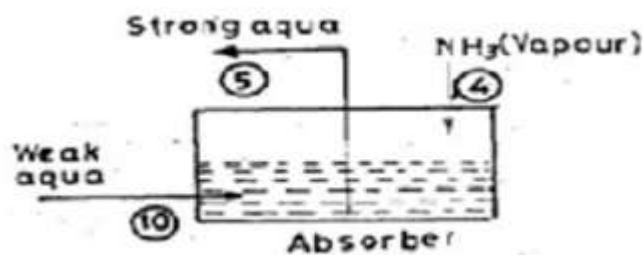
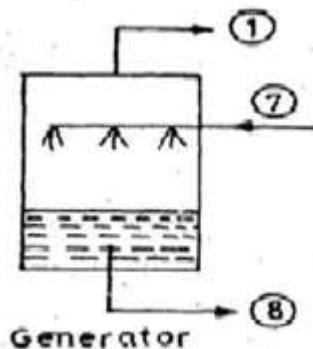

Figure 5 Absorber

2.4. Generator

In generator, strong aqua is heated by supplying heat Q_g , for the generation of High NH_3 vapours



2.5. Design Procedures

A. Nomenclature

- τ =Transmittance of glass cover
- αη= Absorptance of absorber surface
- M =Mass of water (kg)
- C =Average heat capacity of receiver tube (J/kg K)
- T =Change in mass temperature (T)
- At =Change in time period (sec)
- I =Solar radiation (W/m2)
- A =Area of receiver tube exposed to radiation (m2)
- η =Efficiency

B. Collector Area Design

The collector area A can be determined from the following eqn. 1,[1]

$$\tau\alpha = MC \frac{\Delta T}{\Delta t} + \frac{1}{IA} \tag{1}$$

C. Number of Tubes

The determination of number of tubes depends on the size of each tube available commercially. It is given by eqn.2,

$$\text{Number of tubes} = \frac{\text{Collector Area Required}}{\text{Projected area of standard tubes}} \tag{2}$$

Efficiency

The efficiency is calculated using empirical relation [2] as follows:

$$\eta = 0.527 - \frac{0.1736\Delta T}{I} \tag{3}$$

Month	Radiation (kWhr/m2/Day)
January	5.46
February	5.94
March	6.39
April	5.93
May	5.35
June	3.87
July	3.71
August	4.08
September	4.83
October	4.54
November	4.65
December	4.99

TABLE III

Material	Borosilicate Glass
Selective coating materials	AL/SS/CU
Absorption coefficient(a)	0.93
Emission coefficient	0.065
Transmission coefficient (τ)	0.890

III. Calculations

f. Calculations of solar water heater.

Useful energy (energy absorbed by the collector plate) is given by

$$Q_u = K \times S \times A$$

Where,

K=efficiency of collector plate (assume $k=0.85$)

S=average solar heat falling on earth's surface

$$= 6 \text{ kWhr/m}^2/\text{day} = 250 \text{ W/m}^2$$

A=Area of collector plates

Now

$$\text{Heat req. in the generator, } Q_g = 304.2 \text{ KJ/min}$$

$$= 304.2 \times 1000 / 60 \text{ J/s}$$

$$= 5070 \text{ W}$$

Hence approximate area of the collector plates required For providing this much amount of energy = $5070 / (250 \times K)$

$$= 5070 / (250 \times .85)$$

$$= 24 \text{ square meters (approx.) Total Area of collector plates}$$

$$A = 24 \text{ sq m}$$

Therefore, we can use 4 collector plates of having

Dimensions of 3 X 2 sq m.

$$\text{Thus, } Q_u = 0.85 \times 250 \times 24 = 5070 \text{ W} = 5070 \text{ J/s}$$

The energy absorbed by the collector helps in heating Of the water flowing in the tubes of the collector Plates.

$$U = m \times C_p \times (T_o - T_i)$$

Let rate of water flowing through the tubes,

$$m = 1.2 \text{ kg/min} = 0.02 \text{ kg/s, (typical example)}$$

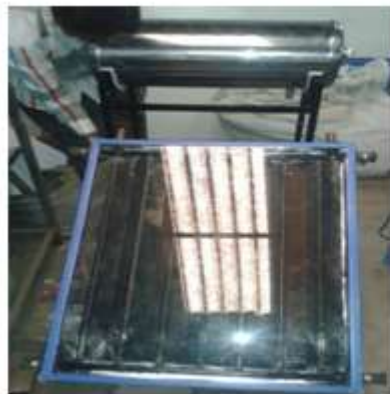

The work done by the pump for raising the pressure is Negligible and hence neglected.



Designed solar collector



Phase one assembly of the system

IV. Results And Discussions

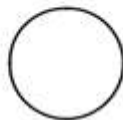
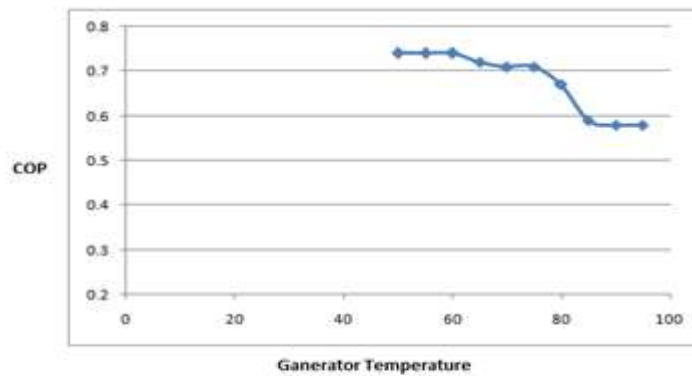

Above graph showing the variation of COP value with different temperatures at the heat generating unit of Ammonia water as a refrigerant.

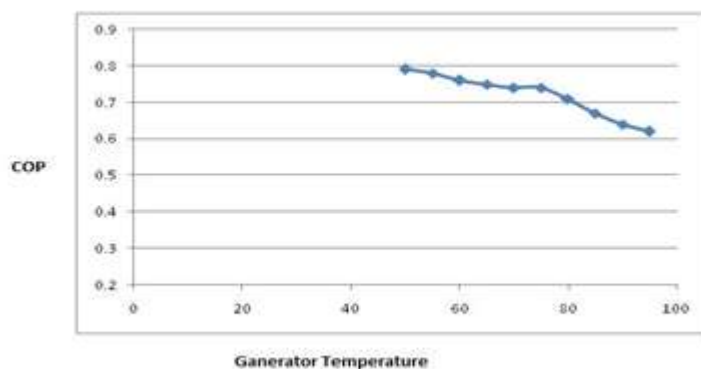

Above graph showing the variation of COP value with different temperatures at the heat generating unit of Ammonium thiocyanate as a refrigerant and this will give you the best COP value compared to the aqua ammonia solution.

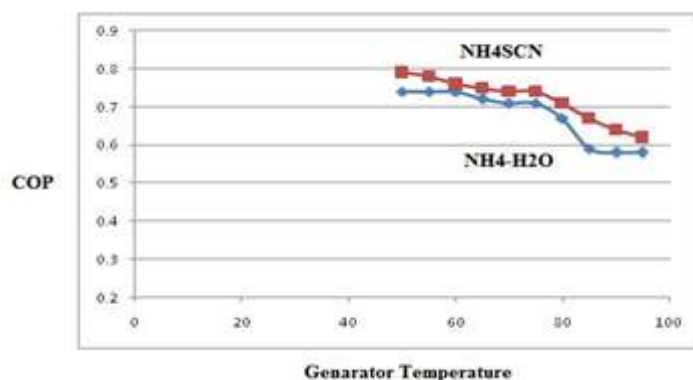

This is the graph showing you the comparison between Ammonia water and ammonium thiocyanate as a working pair and Conclude that improvement in the COP value is obtained ammonium thiocyanate as a working fluid.

4.1. Justification

In this project ammonia-water and ammonium Thiocyanate are employed as working pair to check the performance of the refrigerator and outside of these two-pair associated with working fluids Ammonium Thiocyanate to be a working fluid to receive best COP value on the system. So

Improvement in the COP value is given as, Average COP value for Ammonia Water is = 0.67 Average COP value for Ammonium Thiocyanate is = 0.72 So % age Improvement of COP value is given as

$$(COP) \% \text{ age Improved} = \frac{\text{COP}_{NH4SCN} - \text{COP}_{NH4-H2O}}{\text{COP}_{NH4-H2O}} \times 100$$

$$= \frac{0.72 - 0.67}{0.67} \times 100$$

(COP) % age Improved = 7.4%

So, % age improvement in the COP value for the system is about 7.4% and it can be concluding that Ammonium Thiocyanate can be used as a working pair for the system to obtain better COP value.

Sr No	Particulars	Existing System	Current System	Improvement in the system
1	Electric heater	Yes	Replaces by solar water heater and heater driven by solar power	Due to solar power electrical energy can be saved
2	Pump	Yes	No pump since the system is running due to gravity force	Due to no pump action cost of the pump and electricity can be saved
3	Ammonia water working fluid	Yes	Here the working fluid is replaced by Ammonium Thiocyanate	Cop value of the system is increased by 7.4%

V. Future Scope

Now each day Study on performance of absorption system is taking very good scope to improve the coefficient of Performance with the system. So, in future study is usually continued instead of Aqua ammonia and ammonium Thiocyanate as working fluids they will use Dimethylene-Activated carbon, Ammonia-Lithium Nitroxide as working fluids. With addition towards study of different working pairs, simulation study of the inlet and outlet temperature variations from the generator and simulations may be accomplished for the circulation of refrigerant during the entire system

VI. Conclusion

In this project, solar panel technology is used as a primary source to generate the heat energy to run the actual vapor absorption refrigeration system to uncover the refrigeration effect. So, from the cost and environmental point of view and the availability of the low-grade energy mindset I can conclude that,

- Electrical energy is replaced by the solar energy, due to this overall 31.8% of improvement in the evaporator temperature can be obtained.
- Ammonia water working fluid is replaced by Ammonium Thiocyanate and the improvement in COP value of about 7.4% is achieved.
- In general absorption system use of pumping action is necessary and in this system work has been carried out with the gravity force. So, reduction in the cost of pump and electricity.
- Finally, it is very much necessary to take care of the overall maintenance and cost effectiveness of the system.

References

- [1] Z Crepinsek; Goricanec; J.Krope; comparison of the performances of absorption refrigeration cycles; issue3; volume4; page no 60-76; July 2009
- [2] K. Balaji; R. senthil kumar; Study of vapour absorption using waste heat in sugar industry; issue8; volume2; page no 34-39; Aug 2012
- [3] Sachin kaushik; Dr S.Singh; Thermodynamic analysis of vapour absorption refrigeration system and calculation of COP; issue 2; volume 2; page no 73-80; Feb 2014
- [4] Dr.Nimai Mukhopadhyay; ER. Someshwar Chowdhury; Performance Analysis of Solar Assisted Cascade Refrigeration System of Cold Storage System; issue 4; volume 2; page no 1248-1254; April 2013
- [5] Tarik Shaikh; Prof. Yogesh J. Morabiya; Review Of Solar Absorption Refrigeration System Using Libr-Water and Simulate the Performance of the System; issue 2; volume 2; page no 57-60; March 2013
- [6] R. Fathi; S. Ouaskit; Performance of a Solar LiBr - Water Absorption Refrigeration system; issue 2; volume 2; page no 73-78; June 2007
- [7] V.R.Renjith; P.J.Joshy; Vapour Absorption refrigeration System Using Low Grade Energy –An Ecofriendly Approach; page no 465-472; November 1999

- [8] Mr. S. S. Mali; Prof.M.M.Wagh; Prof. N. N. Shinde; Review of Design of Single Effect Solar Powered Vapour Absorption Air Conditioning System; issue 2; volume 2; page no 10-16; April 2012
- [9] Christy V Vazhappilly; Trijo Tharayil; A.P.Nagarajan; Modeling And Experimental Analysis Of Generator In Vapour Absorption Refrigeration System; issue 5; volume 32; page no 63-67; Sep-Oct 2013
- [10] Satish Raghuvanshi; Govind Maheshwari; Analysis of Ammonia –Water (NH₃-H₂O) Vapor Absorption Refrigeration System based on First Law of Thermodynamics; issue 8; volume 2; page no 1-7; August 2011
- [11] Devashish Tiwari and Dr. Ajeet Kumar Rai, Effect of Sensible Energy Storage Medium on The Productivity of Solar Still. International Journal of Mechanical Engineering and Technology (IJMET) , 7(4), 2016, pp. 1 – 7
- [12] Subhadip Roy; M.P. Maiya; Analysis of R134a–DMAC vapour absorption refrigeration system with add-on components; page no 26-35; Aug 2012
- [13] Refrigeration and Air conditioning by C P Arora
- [14] B. Sandhya Rani, Dr. A. Ramesh, Dr. A.S. Shiva Shak are Gowda and A. Hareesh. Recent Design and Analysis of the Effect of Nozzle at the Outlet of Condenser on Vapour Compression Refrigeration System, International Journal of Mechanical Engineering and Technology (IJMET), 7(6), 2016, pp. 642–659.
- [15] D.S.Kim, C.A.Infante, Ferreira, “ solar refrigeration option a state of the art review”, International journal of refrigeration 3 I,(2008),3-15.
- [16] V.K.Bajpai, “design of solar powered vapor absorption system”, proceeding of the world congress on engineering, 2012 vol-3.
- [17] VSM Solar India Pvt limited Chandapur Bengaluru.
- [18] www.rfuess-mueller.de