

## Enhanced Threshold Sensitive Stable Election Protocol

Shekhar Kumar<sup>1</sup>, S K Verma<sup>2</sup>

CSE Dept, G B Pant Engineering College Ghurdauri, Pauri, India

**Abstract:** A wireless sensor network (WSN) consists of inexpensive power constrained sensor nodes collecting data from the sensing area and transmits data towards the base station in a synergetic way. The basic goal of wireless sensor network is to enhance the node lifespan, stability period and throughput of network. The WSN nodes are restricted by energy, storage capacity, and computing power. So clustering is used to improve lifetime and stability. Cluster routing protocol plays an important role for improvement of energy and stability of the network. In this paper a new technique Enhance Threshold Sensitive Stable Election Protocol (ETSEP) is proposed and evaluated for heterogeneous wireless sensor network. In this technique cluster head election probability dynamically changes. The ETSEP is simulated using MATLAB and found that it performs better than Stable Election Protocol (SEP), Threshold Sensitive Stable Election protocol (TSEP) and Zonal Stable Election Protocol (ZSEP) in terms of stability and network lifetime. ETSEP builds more stable routing environment as compared to SEP, TSEP and ZSEP. Simulation results shows that our protocol performs better than SEP, TSEP and ZSEP.

**Keywords:** Clustering, Data aggregation, Stable-aware routing protocol, Heterogeneous environment, Wireless sensor network.

### I. Introduction

WSN is widely used in various domains like medical diagnoses, industrial processes, military surveillances and traffic management [1]. Wireless sensor network (WSN) consists of diminutive battery powered sensors to monitor physical or environmental conditions from different locations [1]. The wireless sensor node senses the data from different locations and sends this data to the base station which is also called sink. A wireless sensor network has thus become a very effective tool for extracting data from the environment. WSN nodes deployed in the monitoring field may be either fixed or mobile. The lifetime of the node depends on its battery life. Radio energy model (see in fig 1) is used to assess the energy dissipation [1, 3]. According to this model the energy dissipated to transmit K bit message over a distance d is given by:

$$E_{Tx}(K, d) = \begin{cases} K \cdot E_{elec} + K \cdot E_{fs} \cdot d^2 & \text{if } d < d_0 \\ K \cdot E_{elec} + K \cdot E_{amp} \cdot d^4 & \text{if } d \geq d_0 \end{cases} \quad (1)$$

where  $E_{elec}$  is the energy expended per bit to run the circuit and  $d_0$  denotes the crossover distance.  $E_{fs}$  and  $E_{amp}$  are amplifier parameters used for free space propagation model and multipath fading model. If  $d_0$  is greater than d, we use free space model; otherwise multipath fading channel is used.  $E_{Rx}$  is the expanded energy to receive K bit message and described as:

$$E_{Rx}(K) = K \cdot E_{elec} \quad (2)$$

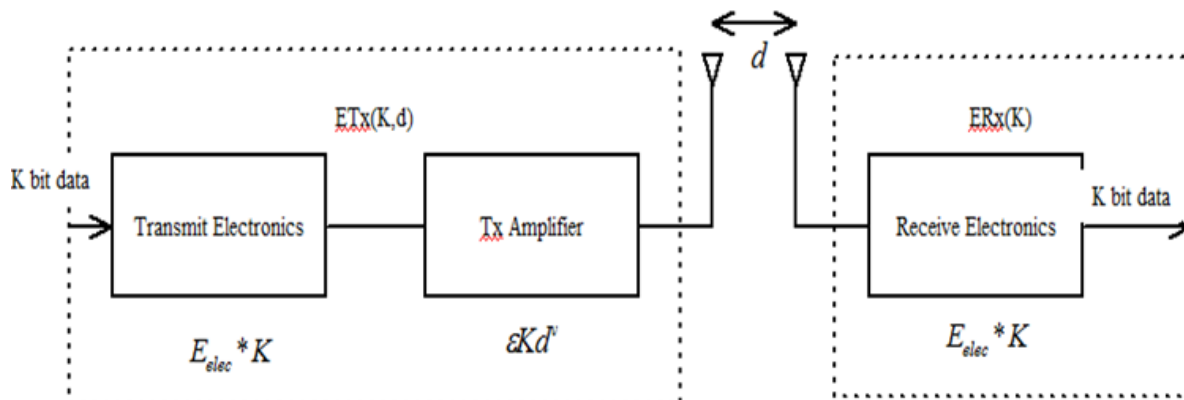
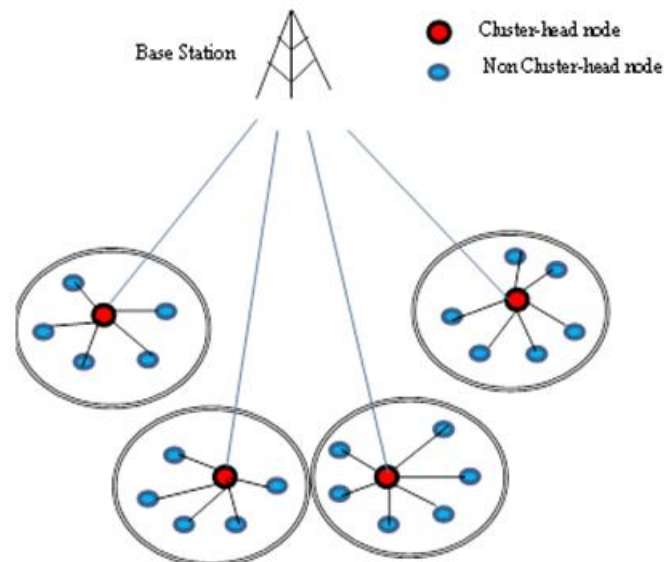

**Fig 1:** Radio Energy Dissipation Model

In last few decades we are focusing on improvement in the energy efficient algorithms. Clustering is one of the best known approaches [3] to improve energy of the network. Clustering is further divided into three phases: cluster head selection, formation and data transmission [2][3] over network. Once the cluster head is elected, it broadcasts advertisement message to the nodes to form a cluster. After cluster formation, the sensor nodes in the cluster send their sensed value to the cluster head during their time slots. The cluster head receives all the data from sensor nodes and aggregate it and then transmit it to the sink (as shown in Fig 2).

Sensor networks can be classified into two types, homogeneous and heterogeneous networks. All nodes have same amount of energy in homogeneous network, while in case of heterogeneous network different level of energy nodes are considered. The energy consumption is superabundantly reduces in clustering approach. In this approach many protocols are used.

Initially two approaches direct transmission and minimum energy transmission was used to transmit the data to base station. Both approaches do not guarantee of well distribution of energy load. In direct transmission approach (DT), sensor nodes transmit the data to the base station directly, and in minimum energy transmission (MTE) data is transferred over minimum cost route path. In direct transmission, the sensor nodes which are far away from the base station will die first due to direct transmission of data. And in case of MTE nodes near the base station act as relays with higher probability than nodes that are far from the base station. So the nodes near the base station will die first. So, in both cases, a part of area is not observed. A solution for this problem was clustering. The first clustering approach is Low Energy Adaptive clustering Hierarchy (LEACH). LEACH is one of the most famous and oldest approaches. In LEACH, the cluster heads are elected dynamically on the basis of election probability. It is a protocol developed only for homogeneous wireless sensor network; it is not as successful for heterogeneous environment. So for such type of heterogeneous networks, many different protocols are considered, Stable Election Protocol (SEP) is one of them. It is cluster based routing protocol, in which cluster head is elected randomly according to the election probability.



**Fig 2:** Cluster based wireless sensor network

In this paper, a protocol names as ETSEP is proposed, in which lifetime, stability and throughput is improved is proposed, and compared with SEP, TSEP and ZSEP in terms of stability, lifetime and throughput of the network. The rest of the paper is further classified into five sections. In section.2, the related work is discussed. The proposed model is introduced in section.3. Simulation results are derived in section 4 and, Conclusion of ETSEP is presented in section 5.

## II. Related Works

Heinzelman et al. [2, 3] proposed a approach for homogeneous network in 2003 named as Low Energy Adaptive clustering Hierarchy (LEACH) protocol. LEACH is a reactive routing hierarchical protocol for heterogeneous wireless sensor network. It is a clustering routing protocol, which elects cluster heads; forms cluster, and transfer the data to the base station after aggregating the data. Due to clustering energy consumption reduced since only the cluster head is transmitting the data to the base station [2] [3]. In the clustering approach, a sensor node randomly elects itself as a cluster head and in an epoch every node has a equal chance to become a cluster head once [1, 8, 9, 10]. The node which wants to become a cluster head for current round choose a

random number between 0 and 1, and a threshold  $T(s)$  is computed. Then picked number is compared with threshold, if the number is less than threshold, the sensor node will become cluster head for the current round. The threshold is calculated as:

$$T(s) = \begin{cases} \frac{p}{1-p*(r \bmod \frac{1}{p})} & \text{if, } s \in G \\ 0 & \text{otherwise} \end{cases} \quad (3)$$

where  $p$  is probability to become a cluster head,  $r$  is current round number and  $G$  is the set of nodes that have not been cluster heads in the last  $1/p$  rounds. LEACH performs well for homogeneous network, but it is not so effective for heterogeneous network.

So, to overcome the weakness of LEACH protocol Smaragdakis et al.[5] proposed a new approach for heterogeneous network named as Stable election protocol (SEP). SEP extends LEACH in which cluster head is elected on the basis of initial energy of node. In this approach, two levels of energy nodes are considered: normal node and advance node. Advance nodes have  $\alpha$  time more energy than normal nodes. Each normal and advance node becomes a cluster head once every  $\frac{1}{p_{opt}} \cdot (1 + \alpha \cdot m)$  rounds and  $(1+\alpha)$  times in every  $\frac{1}{p_{opt}} \cdot (1 + \alpha \cdot m)$  rounds per epoch. Each node which wants to become cluster head selects a random number between 0 and 1, then this number is compared with threshold, if selected number is less than threshold it becomes cluster head for the current round. The threshold for normal node and advance node is calculated as:

$$T(s_{nrm}) = \begin{cases} \frac{p_{nrm}}{1-p_{nrm}*(r \bmod \frac{1}{p_{nrm}})} & \text{if, } s_{nrm} \in G' \\ 0 & \text{otherwise} \end{cases} \quad (4)$$

$$T(s_{adv}) = \begin{cases} \frac{p_{adv}}{1-p_{adv}*(r \bmod \frac{1}{p_{adv}})} & \text{if, } s_{adv} \in G'' \\ 0 & \text{otherwise} \end{cases} \quad (5)$$

where,  $p_{nrm}$  and  $p_{adv}$  are the probabilities for normal and advance nodes,  $r$  is current round,  $G'$  and  $G''$  are the set of normal and advance nodes that have not become cluster head within the last  $\frac{1}{p_{nrm}}$  and  $\frac{1}{p_{adv}}$  rounds. So, in SEP the lifetime and stability is increased due to advance nodes. Thereafter different extension of SEP was proposed. ZSEP [17] is one of them, which uses both techniques direct transmission and clustering for transmission the data according to divide the area into different zones.

As described in [5], a new approach proposed is Threshold sensitive stable election protocol (TSEP) with three level of heterogeneity. In TSEP, CHs selection is threshold based. In this protocol three types of nodes with different energy levels are considered advance nodes, intermediate nodes and normal nodes. In it two types of threshold are considered: soft threshold and hard threshold.

### III. Proposed Etsep

In this section, we present a new approach ETSEP. It is based on threshold sensitive stable election protocol [11]. It is a hierarchical, cluster based reactive routing protocol for heterogeneous network. In this approach we consider three levels of energy of nodes: normal nodes, intermediate nodes and advance nodes. Advance nodes have  $\alpha$  times more energy than normal nodes, and intermediate nodes have  $\beta$  times more energy than normal nodes and we assume that  $\beta=\alpha/2$ . In ETSEP the total energy distributed over the three types of nodes is,  $n \cdot b \cdot (1 + \beta)$ ,  $n \cdot (1 - m - bn) \cdot E_0$  and  $n \cdot m(1 + \alpha) \cdot E_0$ . So, the total energy  $E_{total}$  for all the nodes will be

$$E_{total} = n \cdot (1 - m - bn) \cdot E_0 + n \cdot m \cdot (1 + \alpha) \cdot E_0 + n \cdot b \cdot (1 + \beta) \cdot E_0 = n \cdot E_0(1 + m \cdot \alpha + b \cdot \beta) \quad (6)$$

where,  $m$  is fraction of advance nodes and  $b$  is fraction of intermediate nodes. In ETSEP, the cluster head election probability depends on the residual energy of node at round  $r$  and calculated as:

$$\bar{E}(r) = \frac{1}{N} E_{total} (1 - \frac{r}{R}) \quad (7)$$

In this equation,  $r$  is current round number,  $N$  is total number of nodes,  $E_{total}$  describes the total initial energy of the network and  $R$  denotes the total rounds of the network calculated as  $R = \frac{E_{Total}}{E_{round}}$ . IN a particular round the energy dissipated is denoted as  $E_{round}$ , and calculated as:

$$E_{round} = K(2NE_{elec} + NE_{DA} + kE_{amp} d_{toBS}^4 + NE_{fs} d_{toCH}^2) \quad (8)$$

where,  $k$  is no of clusters,  $K$  is size of message in bits, energy dissipated in data aggregation is  $E_{DA}$ ,  $d_{toBS}$  is the average distance between the CH and the BS, and  $d_{toCH}$  is the average distance between the cluster nodes and the cluster head.

$$d_{toBS} = 0.765 \frac{M}{2} \tag{9}$$

$$d_{toCH} = \frac{M}{\sqrt{2\pi k}} \tag{10}$$

Each node becomes a cluster head by checking the probability of the node. Different nodes have different probabilities to become a cluster head, which are described as:

$$P_{nrm} = \frac{P_{opt}}{1+m.\alpha+b.\beta} \tag{11}$$

$$P_{int} = \frac{P_{opt} (1+\beta)}{1+m.\alpha+b.\beta} \tag{12}$$

$$P_{adv} = \frac{P_{opt} (1+\alpha)}{1+m.\alpha+b.\beta} \tag{13}$$

where  $m$  and  $b$  are the proportion of advance nodes and intermediate node to total number of nodes  $n$ . Initially, each node has same chance to become a cluster head. The node which wants to become a cluster head selects a random number between 0 and 1, and compared with threshold. Here we consider to types of threshold: hard threshold and soft threshold. All nodes continuously sense the environment. As the parameter reaches hard threshold value, the transmitter is turned on and the data is transmitted to the base station. Now this sensed value is stored in a variable in the node. For the next time, and the other nodes will transmit sensed data only if the currently sensed value is greater than the hard threshold or the difference between the sensed value and previously stored value in the variable is equal or greater than soft threshold. In proposed ETSEP the threshold is set on the basis of residual energy of node and optimal number of cluster per round. The threshold is set as:

$$T(s) = \begin{cases} \frac{P}{1-P(\text{rmod } \frac{1}{p})} * \frac{\text{residual energy of node}}{\text{Avg energy of network} * K_{opt}} & \text{if, } s \in G \\ 0 & \text{otherwise} \end{cases} \tag{14}$$

#### IV. Simulation And Results

This section describes the implementation of the proposed scheme ETSEP. MATLAB is used to implement and examine ETSEP. We compare the performance of ETSEP with Stable Election Protocol (SEP) [5], Zonal Stable Election Protocol (ZSEP) [17] and Threshold Sensitive Stable Election Protocol (TSEP) [11]. In comparisons, we consider 100 sensor nodes placed in 100m×100m area. The position of the base station is taken fixed in the middle of the sensing area. In this network, we use radio parameters which are shown in figure 1 for deployment of protocols. The performance of SEP, ZSEP, TSEP and ETSEP is compared with three parameters stability, lifetime and throughput of the network. In the simulation run, we used the following parameters as described in table 1.

**TABLE 1 Parameters used in the simulation**

Parameter	Value
Network field	(100,100)
Number of nodes	25-400
Initial energy( $E_0$ )	0.5J
Message size	4000bits
$E_{elec}$	50nJ/bit
$E_{fs}$	10nJ/bit/m <sup>2</sup>
$E_{amp}$	0.0013pJ/bit/m <sup>2</sup>
$E_{DA}$	5nJ/bit/signal
$P_{opt}$	0.1
$a$	2
$m$	0.1

From the analysis of our results, it is found that ETSEP prolongs the stability period as compared to SEP [6], ZSEP [17] and TSEP [11] algorithms. Figure 3 shows the number of alive nodes per round, it shows that nodes die more slowly in ETSEP in comparison to SEP, ZSEP and TSEP. In SEP, ZSEP, TSEP and ETSEP the first node die at the round number 969, 1847, 2022 and 2329 respectively. By comparing these results we find that ETSEP improves the stability period as compared to other three protocols. Fig 4 shows the number of

dead nodes over the number of rounds, it shows that in SEP, ZSEP, TSEP and in ETSEP all nodes die after 1647, 4113, 5634 and, shows the lifespan of SEP, ZSEP, TSEP and ETSEP, which indicates that the lifetime of ETSEP is better than the remaining three protocols. Figures 5 describes the number of packets sent to the base station which is also called the throughput. The number of packets sent to the base station in SEP, ZSEP, TSEP and ETSEP are 23561, 25827, 282877 and 48323 respectively.

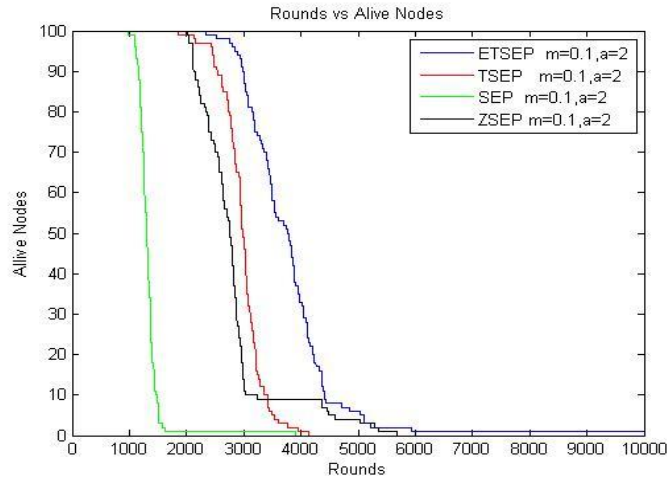

Fig 3: Number of alive nodes during rounds

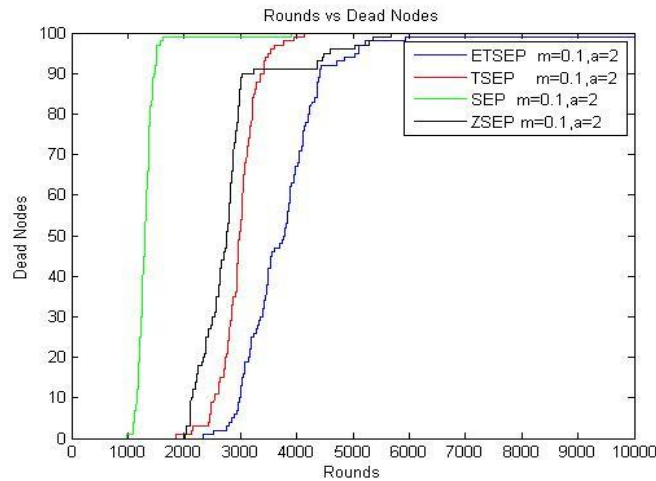

Fig 4: Number of dead nodes during rounds

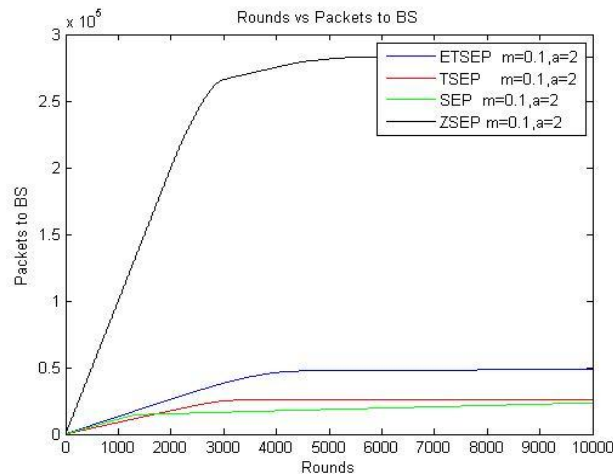

Fig 5: Throughput of the protocols

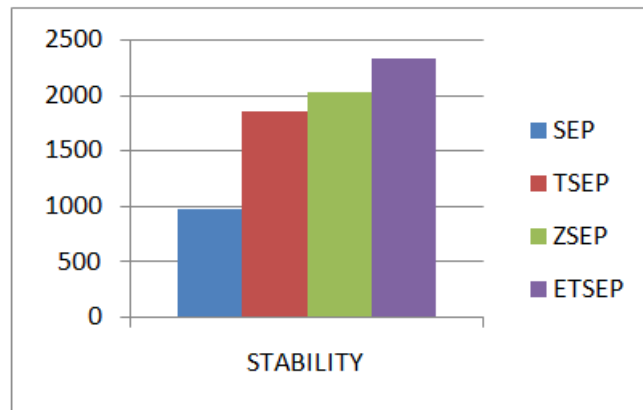

Fig 6: Stability of the protocols

Figure 6 and 7 clearly describes the stability and lifespan of the protocols discussed in this paper.

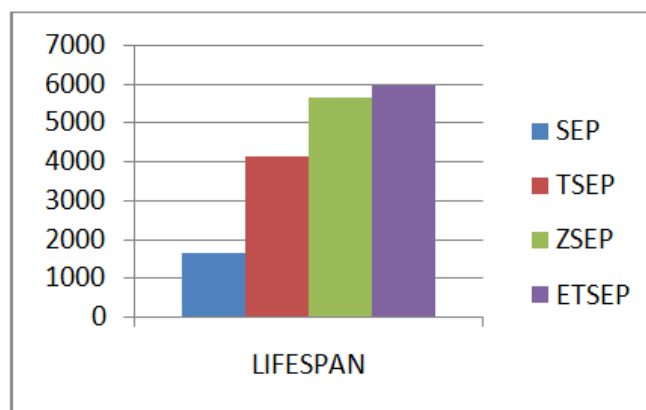

Fig 7: Lifespan of the the protocols

The performance analysis of ETSEP against SEP and TSEP is shown in the following table:

**Table 2 Comparison table of SEP, TSEP and ETSEP**

Protocol	Stability	Lifetime	Throughput
SEP	969	1647	23561
TSEP	1847	4113	25827
ZSEP	2022	5634	282877
ETSEP	2329	5933	48323

### V. Conclusion

Stability period and network life time is one of the key issues for designing the WSN protocols. In this paper, energy aware reactive routing protocol for heterogeneous networks (ETSEP) presented and compared with SEP, ZSEP and TSEP. ETSEP increases the stability period and network lifetime of sensor the proposed protocol is best suited for the WSN environment.

### References

- [1]. Al-Karaki, J.N.; Kamal, AE. "Routing Techniques In Wireless Sensor Networks: A Survey," Wireless Communications, IEEE, Vol.11, No.6, Pp.6,28, Dec. 2004.
- [2]. Heinzelman, W. B. Application-Specific Protocol Architectures For Wireless Networks.Ph.D.Thesis, Massachusetts Institute Of Technology, 2000.
- [3]. Heinzelman, W.R.; Chandrakasan, A.; Balakrishnan, H., "Energy-Efficient Communication Protocol For Wireless Microsensor Networks," System Sciences, Proceedings Of The 33rd Annual Hawaii International Conference On , Vol., No., Pp.10 Pp. Vol.2., 4-7 Jan. 2000
- [4]. T. J. Shepard, "A Channel Access Scheme For Large Dense Packet Radionetworks." In Proceedings Of ACM SIGCOMM, Pp.219230, September 1996.
- [5]. Smaragdakis, G., Matta, I., &Bestavros, A. SEP: A Stable Election Protocol For Clustered Heterogeneous Wireless Sensor Networks. In Second International Workshop On Sensor And Actornetwork Protocols And Applications (SANPA 2004), Boston, MA, Aug. 2004.
- [6]. Femi A. Aderohunmu, Jeremiah D. Deng," An Enhanced Stable Electionprotocol (SEP) For Clustered Heterogeneous WSN." Department Ofinformation Science, University Of Otago, New Zealand.

- [7]. A. Manjeshwar And D. P. Agarwal, "TEEN: A Routing Protocol For Enhanced Efficiency In Wireless Sensor Networks," In 1<sup>st</sup> International Workshop On Parallel And Distributed Computing Issues In Wireless Networks And Mobile Computing, April 2001.
- [8]. U. Sajjanhar, P. Mitra, —Distributive Energy Efficientadaptive Clustering Protocol For Wireless Sensor Networks, Proceedings Of The 2007 International Conference On Mobile Data Management, Pp. 326 - 330, 2007.
- [9]. S. Bandyopadhyay And E. J. Coyle, "An Energy Efficient Hierarchical Clustering Algorithm For Wireless Sensor Networks," In Proceedings Of infocom2003, April 2003.
- [10]. S. Bandyopadhyay And E.J. Coyle, "Minimizing Communication Costs In Hierarchically-Clustered Networks Of Wireless Sensors," Computer Networks, Vol. 44, Issue 1, Pp. 1-16, January 2004.
- [11]. Kashaf, A.; Javaid, N.; Khan, Z.A.; Khan, I.A., "TSEP: Threshold-Sensitive Stable Election Protocol For Wsns," Frontiers Of Information Technology (FIT), 2012 10th International Conference On , Vol., No., Pp.164,168, 17-19 Dec. 2012
- [12]. Islam, M.M.; Matin, M.A.; Mondol, T.K., "Extended Stable Election Protocol (SEP) For Three-Level Hierarchical Clustered Heterogeneous WSN," Wireless Sensor Systems (WSS 2012), IET Conference On , Vol., No., Pp.1,4, 18-19 June 2012
- [13]. Parulsaini And Ajay K Sharma. Article: Energy Efficient Scheme For Clustering Protocol Prolonging The Lifetime Of Heterogeneous Wireless Sensor Networks. International Journal Of Computer Applications 6(2):30–36, September 2010.
- [14]. Awwad, S. A. B., Ng, C. K., Noordin, N. K., Rasid, M. F. A. Cluster Based Routing Protocol For Mobile Nodes In Wireless Sensor Networks. Wireless Personal Communications, 61(2), 251–281, Nov. 2011.
- [15]. Dilip Kumar, Trilok C. Aseri, R.B. Patel, EEHC: Energy Efficient Heterogeneous Clustered Scheme For Wireless Sensor Networks, Computer Communications, Volume 32, Issue 4, Pages 662-667, ISSN 0140-3664, 4 March 2009.
- [16]. M. Mehdi Afsar, Mohammad-H. Tayarani-N, Clustering In Sensor Networks: A Literature Survey, Journal Of Network And Computer Applications, Volume 46, Pages 198-226, ISSN 1084-8045, November 2014.
- [17]. Faisal, S. ; Javaid, Nadeem ; Javaid, Akmal ; Khan, M. A. ; Bouk, Safdar Hussain ; Khan, Z. A.: Z-SEP: Zonal-Stable Election Protocol For Wireless Sensor Networks. In: Corr, Abs/1303.5364, 2013.
- [18]. Islam, M.M.; Matin, M.A.; Mondol, T.K., "Extended Stable Election Protocol (SEP) For Three-Level Hierarchical Clustered Heterogeneous WSN," Wireless Sensor Systems (WSS 2012), IET Conference On , Vol., No., Pp.1,4, 18-19 June 2012.