

Robotic Radioactive Doses Delivery System in Nuclear Medicine Facility

T. Alsennawy⁽¹⁾, Wael Alonazy⁽¹⁾ and *I.E.Saad^{(1)&(2)}

¹Nuclear Medicine Technology department, Inaya Medical College, Riyadh, KSA.

²Clinical Oncology and Nuclear Medicine Department, Faculty of Medicine- Cairo University, Egypt.

Corresponding Author: *Ibrahim E. Saad

Abstract: The nuclear medicine department is a radiation working environment in which patients are diagnosed or treated using radioactive non-sealed sources for tests needed to alleviate their illnesses. For that reason, radiation workers like radiopharmacists, technologists and nuclear medicine physicians should perform extreme measures of protection to every step of each procedure to ensure the safety of the patients and themselves⁽¹⁾. According to the ALARA principle, all exposures should be minimized and all unnecessary exposures must be prevented. Minimizing the exposure time and the use of shielding as well as being at an appropriate distance from the radioactive source are the most practical ways of reducing exposures in the NM department. This is especially true in the therapeutic procedures, where relatively large amounts of radioactivity are handled⁽²⁾.

The aim of this study is to design a robotic system to transport radioactive materials in a nuclear medicine facility.

Materials and methods: A robot was designed and programmed in the form of a carrying movable table that can carry up to seven kilograms and can move through points drawn on the ground after dose preparation for the patient to be taken orally in a remote place, the device can move a distance of five meters. When it reaches the patient, it waits for five minutes until the radioactive material is swallowed and then returns automatically with the empty shield, it is also possible to program the robot for any modification in the nuclear medicine procedures.

Results: The system has been experimented at different movement tracks successfully and also the weight bearing has been tested successfully for carrying up to seven kilograms.

Conclusion: A pre-programmed robotic system was designed and experimented to be used for the purposes of carrying therapeutic doses in nuclear medicine facility for the sake of good radiation protection management.

Date of Submission: 30-10-2017

Date of acceptance: 16-11-2017

I. Introduction

The nuclear medicine department is radiation working environment in which patients are diagnosed or treated using radioactive unsealed sources for tests needed to alleviate their illnesses. The use of unsealed radionuclides in medicine is increasing throughout the world as therapeutic and diagnostic radiopharmaceuticals as well as positron emission tomography (PET) imaging are becoming more common in the clinical environment. For that reason, radiation workers like radiopharmacists, technologists and nuclear physicians should perform extreme measures of protection to every step of each procedure to ensure the safety of the patients and themselves.⁽¹⁾ Exposure to radiation during a medical procedure needs to be justified by weighing up the benefits against the detriments that may be caused. This includes considering the benefits and risks of alternative methods that do not involve any exposure to radiation.⁽²⁾

According to the ALARA principle, all exposures should be minimized and all unnecessary exposures must be prevented. Minimizing the exposure time and the use of shielding as well as being at an appropriate distance from the radioactive source are the most practical ways of reducing exposures in the Nuclear Medicine department. This is especially true in the therapeutic procedures, where relatively large amounts of radioactivity are handled.^{(3),(4)} For that reason, robots have been utilized to minimize the radiation exposure to workers in industry,⁽⁵⁾ reactors as well as in medical field. The first example application examined is from cleanup work performed at the Three Mile Island (TMI) power plant. A remotely driven mobile robot called the Remote Reconnaissance Vehicle (RRV) was designed to carry various tools and a manipulator at TMI. A typical task used the RRV and other remote equipment to leach strontium and cesium contamination from the concrete block wall that surrounded the containment building's elevator and stairwell structures.⁽⁶⁾ The task comprised several remote operations, the most complex of which was injecting water into the cavities in the center of the blocks. Injection required the boring of water injection holes and inserting a water injection nozzle. Wall sources were

in the range of 2 Gy/h to 3 Gy/h (200 to 300 R/h) gamma. Another task was the removal of sludge and contamination from the basement that included cleaning the floor and using a pressure washer to clean walls.⁽⁷⁾ A second application area involves robotic and remote systems operating at a reactor site or support facility. This system deployed in a spent fuel pool at a reactor site working on tasks such as inspection and characterization might encounter very high dose levels in the following ranges. On vertical walls, dose rate is generally less than 1 Gy/h. On the bottom of the pool not directly below the fuel racks, dose rates are below 5 Gy/h. On the bottom of the pool under the storage racks without the fuel rods in place dose rate is less than 50 Gy/h. Under racks with fuel rods in place the dose rate can exceed 200 Gy/h.⁽⁸⁾ Another area is a dry storage cask. In this case, the radiation levels internal to the cask have been reported up to 100 Gy/h, containing both gamma and neutron radiation. For the pressure vessel annulus of the reactor, levels of 100 Gy/h (gamma) and 300 Gy/h (neutron) have been observed. For the lower and upper intervals of the pressure vessel, values of 0.2 Gy/h (gamma) and 0.07 Gy/h have been observed, respectively. Systems operating in a light water reactor waste disposal facility could see dose rates of 2 Gy/h to 3 Gy/h (200 to 300 R/h) ranging upwards to 300 Gy/h (30,000 R/h).^{(9), (10)}

As regard to the robot usage in the field of Medical isotopes, sterilization, irradiation, it was clearly acknowledged that during the production of medical isotopes, exposure rates of 0.014 Gy/h (1400 mR/h) immediately following target bombardment to a steady exposure rate of approximately 0.0035 Gy/h (350 mR/h) five to seven days following bombardment have been observed⁽¹⁰⁾. Consequently, remote target handling equipment needs to be designed to support these exposure rates over the life of the facility, and this is especially challenging whenever increased demand necessitates increased throughput and higher system availability. A typical dose for a food and medical products sterilization facility treating a medical product might be 25 kGy gamma and for a food product 4 kGy⁽¹¹⁾. Dose rate in an irradiator found in a research facility might range as high as 20 kGy/h. In an industrial irradiation facility (consider one that might contain 3 MCi of cobalt-60), the dose rate might range to 100 kGy/h near the source; however, it is generally around 10 kGy/h.⁽¹²⁾

In the field of nuclear medicine, the most common procedure that may result in relatively high exposure to the workers is the radioiodine therapy. Iodine-131 has been used for over 60 years in the treatment of patients with DTC, to destroy both remaining thyroid cells and carcinoma foci. However, the indications for radioiodine therapy continue to be debated.^(13,14) Radioiodine therapy of DTC is based on the ability of tumor cells to accumulate iodine, leading to intensive, selective, and tumoricidal irradiation⁽¹⁵⁾. Iodine-131 has a physical half-life of 8.05 days. It decays by high-energy gamma photon (364 keV) and particulate emissions (beta particle). The beta emission has an average energy of 192 keV [max energy = 607 keV (90%), and 810 keV (7%)] and the beta particle will deposit its energy within 2.2 mm (90%) and 3.1 mm (7%), respectively of its site of origin. with a mean tissue range of only 0.8 mm. The success of thyroid ablation with I-131 depends mainly on the mass of remaining thyroid tissue in the neck and the initial dose rate to this tissue.⁽¹⁶⁾ The administration of the I-131 to the patient may be in the form of liquid solution or in the form of capsules. Both forms have its own benefits and risks. Capsules are more convenient, but have generally been more expensive. Liquid formulations may require extra measures to minimize radiation contamination at the time of administration. RAI in capsules and liquid are generally believed to be equivalent in efficacy, although there has been some concern regarding a reduction in RAI bioavailability from capsules, because of incomplete dissolution related to the amount of magnesium stearate in the capsule.⁽¹⁷⁾ There are a variety of nuclear medicine therapy procedures which is used for treatment of various types of diseases like phosphorus-32-sodium phosphate and Strontium89, Samarium-153, Rhenium 186 that are used for Palliation of Bone Pain from Osteoblastic Metastases.⁽¹⁷⁾

The introduction of PET tracers has been widely used in the field of molecular imaging, the transportation of PET tracers within the cyclotron facility as well as the transportation within the imaging facility may contribute to high radiation doses for workers which requires introduction of new ways of protection.⁽¹²⁾ Other applications and dose ranges are: medical diagnosis 10—100 mGy, medical therapy 1—10 Gy, industrial food and agriculture processing 0.1—10 kGy, industrial sterilization 10—30 Gy, and industrial materials modification 50—100 Gy. Systems designed to handle these products are expected to work for a long period with high reliability, but depending upon the design and use requirements, these systems may be able to be located in a shielded area whenever the highest exposures are present.⁽¹¹⁾

Aim of the work: is to design a robotic system to transport radioactive materials in a nuclear medicine facility.

II. Materials And Methods

The robot is designed to transport subjects from place to place guided by a colored strip on the floor to assign the path of motion and it is programmed to wait for 5 minutes and returns back to the original place. And this design will help the nuclear medicine worker whom handles the delivery of radioactive materials to patients in a n isolated place without further exposure to the dose during administration by the patients. The robot was designed by using a software for programming as follows:

System design and component

1- Regulated Power Supply

2-Megapi Arduino

Megapi Arduinos a main control board upgraded and improved for teaching and entertainment on the basis of Arduino Uno. With powerful driving ability and maximum output power of 36W (3A), it can drive four DC motors simultaneously. Well-designed color system is used with sensor modules perfectly, and eight user-friendly independent RJ25 ports implements circuit connection easily. In addition, it supports most Arduino programming tools (Arduino/ArduBlock), and provides the GUI programming tool upgraded from Scratch and mobile APP to meet the needs of various users. Figure 1

Specifications

- Output voltage: 5V DC
- Input voltage: 6V-12V DC
- Maximum input current: 3A
- Communication mode: UART, I²C, digital I/O, analog input
- Control chip: Atmega 328P
- Dimension: 80 x 60 x 18 mm (L x W x H)

Figure (1)

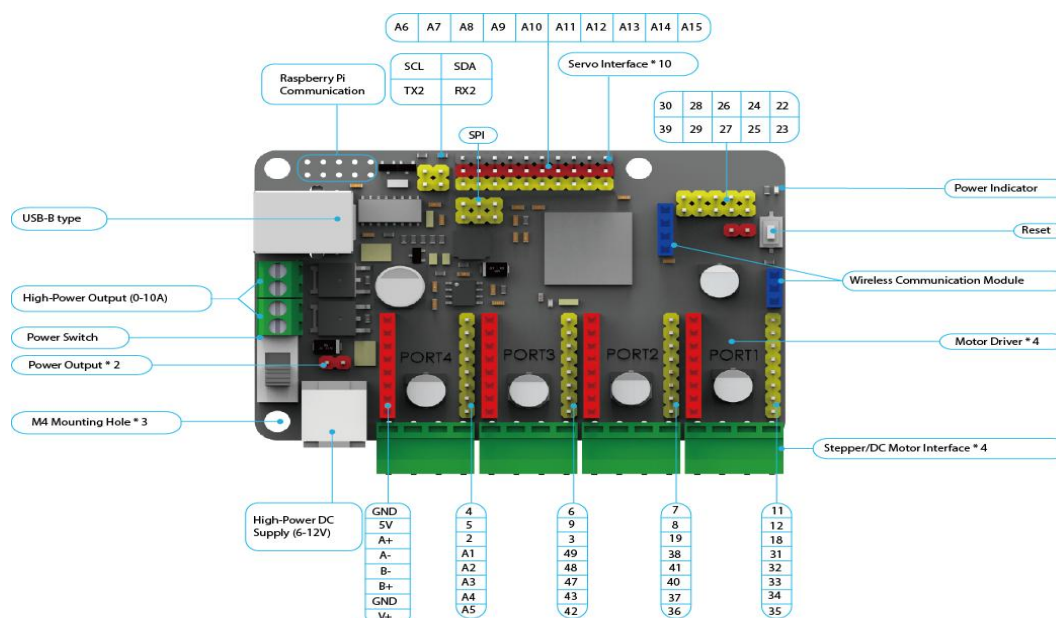
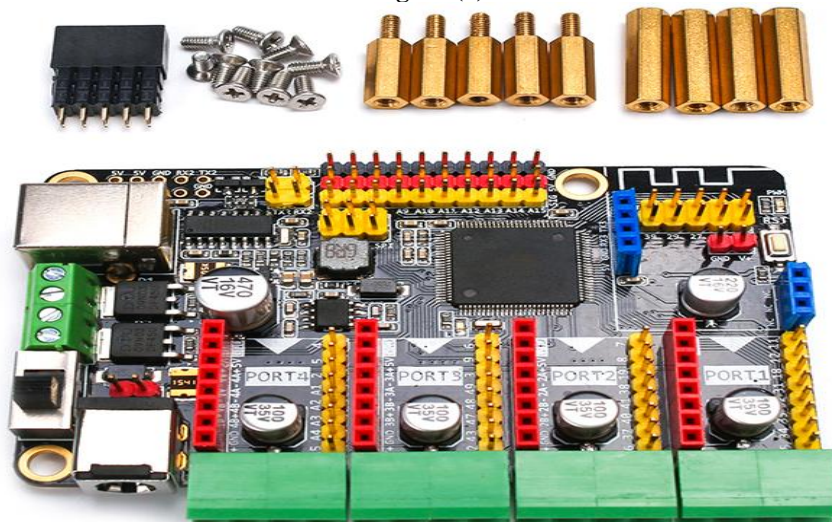







Figure (2) Megapi Arduino Specifications

Color	Function	Module using this port
	Red means the output voltage is 6-12V, and it is usually connected to the motor driver module of 6-12V voltage	<ul style="list-style-type: none"> ● Me DC Motor Driver ● Me Stepper Motor Driver ● Me Encoder Motor Driver
	Single-digital port	<ul style="list-style-type: none"> ● Me Ultrasonic Sensor ● Me RGB LED
	Double-digital port	<ul style="list-style-type: none"> ● Me 7-Segment Display ● Me PIR Motion Sensor ● Me Shutter Cable ● Me Line Follower ● Me IR Receiver
	Serial port of hardware	<ul style="list-style-type: none"> ● Me Bluetooth Module (Dual Mode) ● Me WiFi Module
	Analog signal port	<ul style="list-style-type: none"> ● Me Light Sensor ● Me Potentiometer ● Me Joystick ● Me 4-Button ● Me Sound Sensor
	PC port	<ul style="list-style-type: none"> ● Me 3-Axis Accelerometer and Gyro Sensor ● Me Compass

Features

- Four motor driver interfaces for adding encoder motor driver and stepper motor driver, and thus to drive DC motors, encoder motors and stepper motors.
- One wireless communication interface for adding Bluetooth module or 2.4G module.
- Ten servo interfaces which enable the board to drive up to 10 servos at the same time.
- Two high-power MOS driver interface which is able to drive devices with a maximum current of 10A. Maximum current output of DC 5V output port is 3A.
- One Raspberry Pi switch interface (requires manual soldering) to realize 5V to 3.3V serial communication.

III. DC Motor Driver

Two 12v motors 250rpm

Overview

The Me Dual Motor Driver module can drive two DC motors by the onboard RJ25 port with power supply of 6V-12V, and it also has the PWM speed regulation function. The IC used in the module is an efficient, low heat dissipated. MOSFET with over-current protection function. Its red ID means that it should be connected to the port with red ID.



Figure (3) DC Motor Driver

Technical specifications

- Operating voltage: 6-12V DC.
- Single channel sustained output current: 1.2A.
- Single channel peak output current: 3.2A.
- Number of motor channels: 2.
- Type of drive motor: DC motor.
- Control mode: 2 I/O (direction and PWM speed regulation).
- Module size: 56 x 32 x 18 mm (L x W x H).

Functional characteristics

- White area of module is the reference area to contact metal beams.
- Equipped with effective MOSFET H-bridge-based motor driver module IC.
- Maximum 1.2A sustained current for each motor (peak value 3.2A).
- Over-current protection (OCP).
- Support Arduino IDE programming and provide runtime library to simplify programming.
- Support mBlock GUI programming, and applicable to users of all ages.
- Adopt RJ25 port for easy connection.
- Provide pin-type port to support most Arduino Baseboards.

Pin definition

The port of Me Dual Motor Driver has four pins, and their functions are as follows:

Table 1 DC Motor Driver Pin definition

No.	Pin	Function
1	PWM	Pulse width modulation (speed regulation)
2	DIR	Direction control
3	GND	Grounding
4	V-M	Motor power 6~12V (DC)

Wiring mode

- connecting with RJ25

since the port of Me Dual Motor Driver has red ID, you need to connect the port with red ID when using RJ25 port. you can connect it to ports No. 1 and 2 as follows:

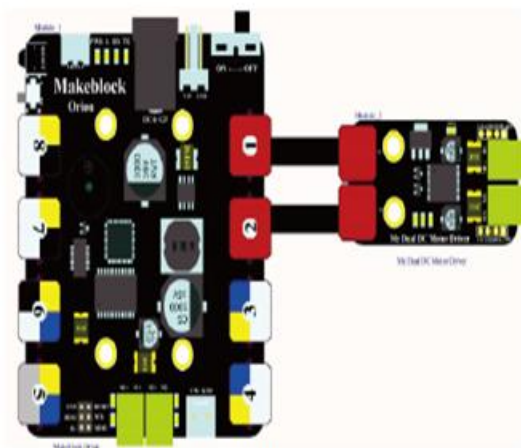

Figure (4) Line Follower Sensor

Overview

This module has a potentiometer which can be used to adjust the detection range. The level of Mode pin can be controlled to select the operating mode. When it is in high level, the module can be triggered repeatedly for real-time induction. When it is in low level, the module is in non-repeatable trigger mode. If somebody is moving in the induction range, the module is triggered and maintained for a period of time. In this period, the state will not be interfered whether there is somebody moving in the deduction range.

Technical specifications

- Operating voltage: 5V DC.
- Detection range: 1~2cm.
- Detection angle: within 120°.
- Control mode: Double-digital port control.
- Module dimension: 51 x 24 x 21mm (L x W x H).

Functional characteristics

- White area of module is the reference area to contact metal beams.
- Provide two LED indicators for feedback during line-following.
- Anti-reverse protection – connecting the power supply inversely will not damage IC.
- Easy to be influenced by natural light, and limited by greatly changed ambient light.
- Support Megapiarduino GUI programming, and applicable to users of all ages.
- Adopt RJ25 port for easy connection.
- Provide pin-type port to support most development boards including Arduino series.

Pin definition

Table 2 The port of Me Line Follower

No.	Pin	Function
1	GND	Grounding
2	VCC	Power supply
3	S1	Data output of sensor 1
4	S2	Data output of sensor 2

Wiring mode

- Connecting with RJ25

Since the port of Me Line Follower has blue ID, you need to connect the port with blue ID on Makeblock Orion when using RJ25 port. Taking Makeblock Orion.

as example, you can connect to ports No. 3, 4, 5, and 6 as follows:

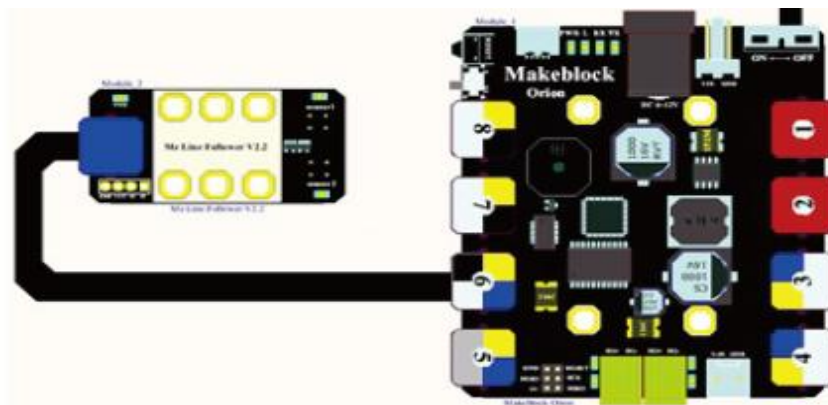

IV. Results

The robot has been successfully designed and tested to transport radioactive material through a track drawn on the ground after preparation for the patient to be taken orally. The device can move from the hot lab to the injection room, moving about five meters and can carry up to 7 kg. When it reaches the patient, it waits for five minutes until the radioactive material is swallowed and then returns automatically, it is also possible to use the device in all procedures of treatment in nuclear medicine by different doses in each procedure and by adjusting the motion track as well as the waiting time in each procedure.

Final shape of the robot



Figure 5 Robot

V. Conclusion

The radiation levels in nuclear medicine application can sufficiently justify the application of robotics in radioactive materials transportation. By proper selection of the components giving attention to its radiation resistance. The robot systems can employ a remotely operated devices that can provide the required tasks with sufficient reliability in nuclear medicine and similar nuclear environments. The main benefit of the presented robot is to serve the application of two basic principles of radiation protection as it reduces the radiation exposure of those working in the nuclear medicine department by reducing the time of exposure and increasing the distance from the patient. This can be achieved through the robotic delivery of radioactive material and without direct contact with the patient during administration. There will be no waiting time by the worker for the patient to swallow the radioactive material as the robot will return automatically after a predetermined period of time. Also the heavy weight of the shielding of the radiation source will be waived from the worker.

References

- 1) Thomson WH, Harding LK. Radiation protection issues associated with nuclear medicine out-patients. *Nucl Med Commun* 1995;16:879-892.
- 2) Culver CM, Dworkin HJ. Comparison of personnel radiation dosimetry from myocardial perfusion scintigraphy: technetium- 99m-sestamibi versus thallium-201. *J Nucl Med* 1993;34: 1210-1213.
- 3) Schurnbrand P, Schicha H, Thal H, Emrich D. External radiation exposure of personnel working with 99m Technetium. *Eur J Nucl Med* 1982;7:237-239.
- 4) Harding LK, Harding NJ, Warren H, Mills A, Thomson WH. The radiation dose to accompanying nurses, relatives and other patients in a nuclear medicine department waiting room. *Nucl Med Commun* 1990;11:7-22.
- 5) Lamarsh, J.R. and Baratta, A.J., "Introduction to Nuclear Engineering, 3rd Edition," Prentice Hall, Upper Saddle River, New Jersey, 2001.
- 6) Houssay, L.P., 2000, "Robotics and Radiation hardening in the Nuclear Industry," M.S. Thesis, Univ. of Florida, Gainesville, 2000.
- 7) Bzorgi, F.M., "Summary of Remotely Operated Systems Designed for Inspection, Decontamination, and Decommissioning," Bechtel National Inc. Oak Ridge, TN, 1996.
- 8) Inajima, T., "Tepco Detects High Radiation Levels Inside Fukushima Reactor," Bloomberg online, March 27, 2012.
- 9) Boothe T.E. and McLeod, T.F., "Radiation Safety Aspects of Production of Commercial Levels of Medical Radioisotopes," *Nuclear Instruments and Methods in Physics Research B79*, pp. 945-948, 1993.
- 10) Eastman Specialty Products, "Sterilization of Medical Devices & Packaging," Eastman Chemical Company, Kingsport, TN, 2010.
- 11) International Atomic Energy Agency, "Gamma Irradiators for Radiation Processing," Vienna, Austria.
- 12) Radiation Protection and Safety of Radiation Sources: International Basic Safety Standards General Safety Requirements Part 3 INTERNATIONAL ATOMIC ENERGY AGENCY VIENNA ISBN 978-92-0-135310-8 ISSN 1020-525X No. GSR Part 3, 2014.
- 13) Hay ID. Papillary thyroid carcinoma. *EndocrMetabClin North Am* 1990; 19: 545-576.
- 14) Gharib H. Thyroid nodules and multinodular Goiter. In: Cooper DS, ed. *medical management of thyroid disease*. New York: Marcel Dekker 2001:187-225.
- 15) Voutilainen PE, Siironen P, Franssila KO, et al. AMES, MACIS and TNM prognostic classifications in papillary thyroid carcinoma. *Anticancer Res* 2003; 23(5b):4283-4288.
- 16) Haldemann AR. The basis for radioiodine therapy in differentiated thyroid cancer. *Ther Umsch* 1999; 56(7):403-407. General Principles.
- 17) Bender JM, Dworkin HJ. Iodine-131 as an oncology agent. *J Nucl Med Technol* 1993; 21:140-150

T. Alsennawy Robotic Radioactive Doses Delivery System in Nuclear Medicine Facility." *IOSR Journal of Applied Physics (IOSR-JAP)* , vol. 9, no. 6, 2017, pp. 34-40.