

Spectrophotometric Hybrid Flow System for Determination of *N*-Acetyl-L-Cysteine in Pharmaceuticals

Kraljević T.¹, Jelić-Knezović N.², Marković Boras M.³, Ćurlin M.⁴

¹Department of Chemistry, Faculty of Science and Education/University of Mostar, Matice hrvatske bb, 88000 Mostar, Bosnia and Herzegovina

²School of Medicine/University of Mostar, Bijeli Brijeg bb, 88000 Mostar, Bosnia and Herzegovina

³Department of Laboratory Medicine/University Clinical Hospital Mostar, Bijeli Brijeg bb, 88000 Mostar, Bosnia and Herzegovina

⁴Faculty of Health Studies/University of Mostar, Bijeli Brijeg bb, 88000 Mostar, Bosnia and Herzegovina
Corresponding Author: Kraljević T.

Abstract: A simple hybrid flow system is proposed for the determination of *N*-acetyl-L-cysteine based on the reaction between copper(II)-neocuproine and *N*-acetyl-L-cysteine, yielding an orange-yellow copper(I)-neocuproine complex with absorption maximum at 458 nm. The method involved injection of approximately 300 μL of sample/standard and 300 μL reagent solution simultaneously. The optimum conditions were evaluated, calibration curve was linear over the range of 1.0×10^{-6} - 1.0×10^{-4} mol L⁻¹ of *N*-acetyl-L-cysteine with detection limit of 2.7×10^{-7} mol L⁻¹. A sample throughput of 100 h⁻¹ was obtained. This hybrid flow technique was found to be simple, accurate, reproducible and sensitive. The developed method was successfully applied for the determination of *N*-acetyl-L-cysteine in pharmaceutical preparations.

Key Words: Hybrid flow system, spectrophotometry, *N*-acetyl-L-cysteine

Date of Submission: 18-05-2020

Date of Acceptance: 03-06-2020

I. Introduction

N-acetyl-L-cysteine (NAC, also known as *N*-acetylcysteine, acetylcysteine, 2-acetamido-3-sulfanylpropanoic acid) is a pharmaceutical preparation and a dietary supplement. It is used primarily as a mucolytic agent and in case of paracetamol overdose. *N*-acetyl-L-cysteine is a synthetic *N*-acetyl derivative of the amino acid L-cysteine, where the acetyl group is attached to a nitrogen atom. This compound is sold as a dietary supplement due to its antioxidant action and protective effect on the liver.[1] It is used as a cough medicine because it breaks the disulfide bonds in the mucus which makes coughing easier. In the respiratory system, *N*-acetyl-L-cysteine exhibits secretomotor and secretolytic effects.[2] *N*-acetyl-L-cysteine degrades the disulfide bonds of mucopolysaccharide chains and has a depolymerizing effect on DNA chains (in purulent mucus), which reduces the viscosity of bronchial secretions. It also has a mucoregulatory effect, i.e. it regulates the secretion of mucus during inflammation and reduces the production of mucous secretions. The second mechanism of action of *N*-acetyl-L-cysteine is based on the ability of its reactive SH-groups to bind chemical radicals and their detoxification.[3] It is used as an antidote for severe paracetamol poisoning. *N*-acetyl-L-cysteine increases the synthesis of glutathione in the liver, a tripeptide important for detoxifying harmful substances.[4] A prophylactic effect of acetylcysteine on the frequency and severity of exacerbations of bacterial infections has been observed in patients with chronic bronchitis and mucoviscidosis. *N*-acetyl-L-cysteine is rapidly and almost completely absorbed from the gastrointestinal tract after oral administration.[5] About 50% of *N*-acetyl-L-cysteine is bound to plasma proteins. It is metabolized in the liver to cysteine (active metabolite), diacetyl-cystine, cystine and other mixed disulfides. *N*-acetyl-L-cysteine and its metabolites are present in three different forms: they are partially free, bound to proteins by labile disulfide bonds, or incorporated into amino acids. The excretion of *N*-acetyl-L-cysteine is almost exclusively done by the kidneys, in the form of inactive metabolites (inorganic sulfates, diacetyl-cystine).[6] Different methods of *N*-acetyl-L-cysteine determination have been described. The European Pharmacopoeia recommends iodometric titration for *N*-acetyl-L-cysteine determination in pharmaceutical preparations.[7] Other methods described in the literature include: titrimetry[8], fluorimetry[9], chromatography[10], potentiometry[11], conductometry[12], voltammetry[13] and spectrophotometry[14]. A number of *N*-acetyl-L-cysteine determination methods based on flow techniques such as flow injection analysis[15, 16] and sequential injection analysis[17,18] have been developed. The flow injection technique allows a large number of analysis per unit time while requiring a relatively large consumption of analyte and reagent solutions. The sequential injection system allows low consumption of analyte and reagent solutions but the system itself is costly. Aim of the research presented in this paper is the

optimization of a new affordable, simple and sensitive spectrophotometric method for *N*-acetyl-L-cysteine determination using a simple hybrid flow system. The developed method is based on the reaction of formation of a stable yellow-orange Cu(I)-neocuproine complex with maximum absorbance at a wavelength of 458 nm.[19] In the process of developing this method, the basic characteristics of the hybrid flow system were optimized, achieving good sensitivity of the method and frequency of measurements with minimal reagent and analyte solutions consumption.

II. Material And Methods

Reagents: All chemicals were of analytical reagent grade and all solutions were prepared in deionized water (Milli Q, Milipore, Saint Quentin, Yvelines France, 18,2 MΩ) unless otherwise stated. A Britton-Robinson buffer solution was prepared by mixing equimolar concentrations ($4.0 \times 10^{-2} \text{ mol L}^{-1}$) of acetic, boric and phosphoric acid. Buffer solution of pH 3.00 was prepared by transferring a portion of stock buffer solution of pH 2.00 and adjusting to the desired pH by adding 2.0 mol L^{-1} sodium hydroxide solution. A WTW™ inoLab™ 7110 benchtop pH Meter (Xylem Analytics Germany GmbH) equipped with a combined glass electrode (IDS Electrode BlueLine 14 pH - SI Analytics) was used for all pH measurements. A stock standard *N*-acetyl-L-cysteine solution ($1.0 \times 10^{-2} \text{ mol L}^{-1}$) was prepared by dissolving 163,2 mg of *N*-acetyl-L-cysteine (Merck, Darmstadt, Germany) in Britton-Robinson buffer solution (pH = 2.0) made up to a 100.0 mL in a volumetric flask. The solution prepared by the described procedure was stored at 4 °C and was stable for 30 days. A standard copper(II)-neocuproine solution ($c(\text{CuNc})_2^{2+} = 1 \times 10^{-3} \text{ mol L}^{-1}$ molar ratio of 1:2.4 was prepared in a calibrated 100 mL volumetric flask by dissolving approximately 25 mg of $\text{CuSO}_4 \times 5\text{H}_2\text{O}$ (Kemika, Zagreb, Croatia) in a small volume of a Britton-Robinson buffer solution, pH = 3.0. After copper had been dissolved, 50 mg of neocuproine was added (Sigma Aldrich, Steinheim, Austria) and copper(II)-neocuproine complex was formed. [20] The volumetric flask was filled to the 100 mL mark. The stock solution was stable for 30 days stored at 4° C. Working analyte and reagent solutions were prepared daily by diluting the appropriate volumes of stock solutions with Britton-Robinson buffer solution (pH = 3.0). Distilled water was used as carrier solution.

Configuration of the proposed hybrid flow system

The hybrid flow system outlined schematically in Figure 1. was constructed using the following components: an eight-channel peristaltic pump (Ismatec, Zurich, Switzerland), two solenoid controlled isolation valves (Bio-Chem Fluidics, New Jersey, USA), confluence point Chemifold Type II (Tecator, USA) and a double beam UV-Vis spectrophotometer (UV-1800 Shimadzu Kyoto, Japan). The spectrophotometer was equipped with an 80 μL internal volume and 10 mm optical path flow cell (Hellma, Jamaica, NY).

PTFE Tygon tubing of 0.8 mm i.d. and two-stop Tygon peristaltic pump tubing of 1.30 mm i.d. with corresponding PTFE fittings was used to assemble the proposed hybrid flow system manifold.

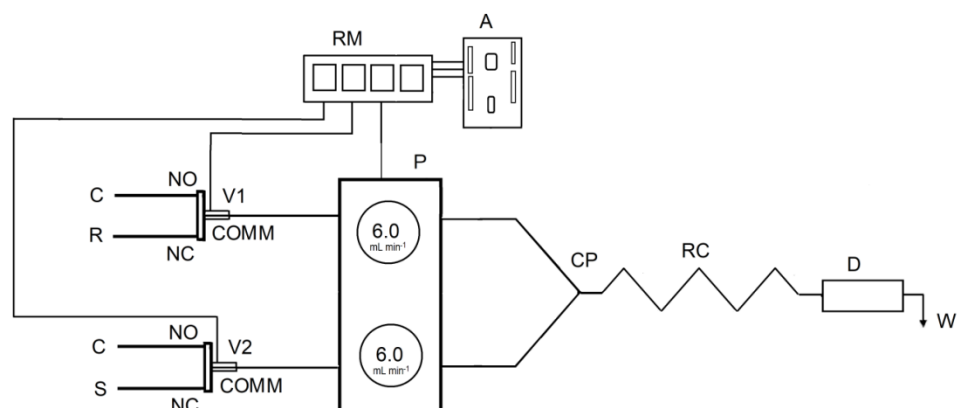

Figure 1. A – arduino, RM – relay module, C – carrier, V1 – isolation valve 1 (NO – normally open port, NC – normally closed port, COMM – common port), V2 – isolation valve 2, P – peristaltic pump, S – sample, R – reagent, CP – confluence point, RC – reaction coil, D – detector, W – waste.

The detector was connected to a personal computer via usb communication port and UVProbe software (Version 2.31 Shimadzu Corporation) for spectrophotometer control and data acquisition. The monitoring wavelength was set to 458 nm. GraphPadPrism 5 was used for statistical analysis and graphical presentation of the obtained data.

Three-way isolation valves have three ports, normally closed, normally open and common. In its natural de-energized state, fluid flows between the normally open and the common port. The valve is switched by energizing, and fluid changes path and flows between the normally closed and the common port.



Figure 2. Valves used in this research

Arduino UNO, a programmable micro controller in conjunction with a relay module was used to control the isolation valves. IDE software developed for Arduino version 1.0.6 was used to write the code. The system configuration allows controlled consumption of analyte and reagent solutions by changing the position of the isolation valves while the peristaltic pump continuously dispenses the solutions. The isolation valves and the precise peristaltic pump allow for accurate dosing of reagents and analyte solutions, whereas the microcontroller provides reproducible opening and closing of the isolation valves.

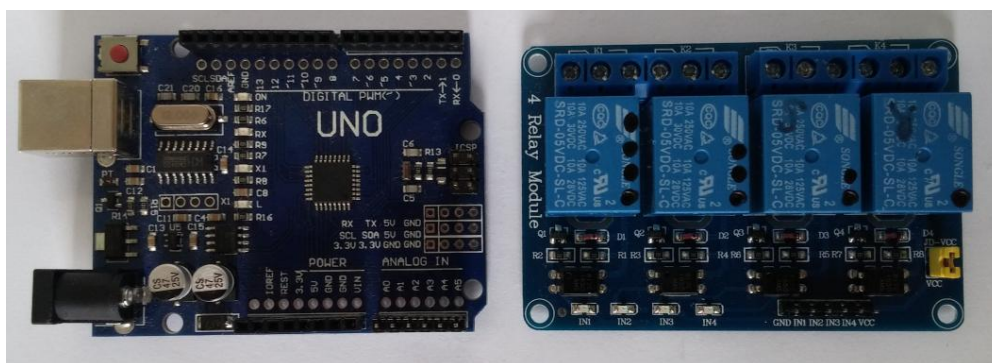

Figure 3. Arduino UNO and relay module

Procedure

The common port of the isolation valves were connected to the two-stop Tygon peristaltic pump tubing mounted on the peristaltic pump. The two tubes merge at the confluence point connected to the reaction coil and the flow cell. The PTFE tubes connected to the normally open ports of the two valves were immersed in deionized water. The tubes connected to the normally closed positions were immersed in the reagent and analyte solutions respectively. The two isolation valves were set to normally open position and through the system the carrier solution was dispensed for 30 seconds by the peristaltic pump at a flow rate of 6.0 mL min^{-1} . At this flow rate the resulting volume of carrier through each tube was 3.0 mL . The two tubes merge at the confluence point resulting in a flow rate of 12.0 mL min^{-1} through the reaction coil and the flow cell. This procedure was employed to procure a stable baseline. Switching the isolation valves to normally closed position for three seconds, flow rate of 6.0 mL min^{-1} and switching back to normally open position after the three seconds have elapsed, dispenses $300 \text{ }\mu\text{L}$ of reagent and analyte respectively.

Table 1. Optimized program sequence for the proposed flow system

Pump	Valve 1 position	Volume (mL)	Valve 2 position	Volume (mL)	Flow rate (mL min^{-1})	Operation time (s)*	Description
Dispense	NO	3.0	NO	3.0	6.0	30.0	Switch valves by de-energizing to NO position (dispense carrier)
Dispense	NC	0.3	NC	0.3	6.0	3.0	Switch valves by energizing to NC position (dispense analyte and reagent respectively)

*Note: Operation time and flow rate are assigned, volume is calculated.

The dispensed zones of reagent and analyte come in contact in the reaction coil forming a reaction product. The absorbance of the formed copper(I)-neocuproine complex was recorded at a wavelength of 458 nm. The sequence for the determination of *N*-acetyl-L-cysteine by the proposed hybrid flow method with spectrophotometric detection is outlined in Table 1.

III. Results and discussion

Optimization of chemical parameters and parameters of the hybrid flow system

The proposed method is based on a redox-reaction, in which *N*-acetyl-L-cysteine reduces the copper(II)-neocuproine complex to an orange-yellow copper(I)-neocuproine complex:



From the chemical reaction equation it is clear that the concentration of *N*-acetyl-L-cysteine is proportional to the concentration of copper(I)-neocuproine.

Chemical parameters

Chemical parameters examined were pH value and reagent concentration.

The effect of pH on signal height was examined using Britton-Robinson buffer solutions in the range of 2.0 to 8.0. The recorded absorbance value varied very little in the studied area. With a further increase in pH, a small increase in signal height was observed, pH = 3.0 was chosen as the optimum pH value, due to the stability of *N*-acetyl-L-cysteine at lower pH values.

The reagent concentration was studied in the range of 1.0×10^{-4} - 1.0×10^{-3} mol L⁻¹ of copper(II)-neocuproine complex. An increase in reagent concentration consequently increased the sensitivity of the proposed method. The highest analytical signal was recorded at reagent concentration of 5×10^{-4} mol L⁻¹, therefore this concentration was chosen as an optimum value and used through the optimization procedure.

Physical parameters

The aim of this research is the optimization, evaluation and application of the proposed method of *N*-acetyl-L-cysteine determination using the hybrid flow system with a spectrophotometric detector. The parameters of the flow system are optimized taking into account two often diametrically opposed requirements: sensitivity and high frequency of analysis. The optimization of physical parameters was conducted by applying a univariate method, where one selected parameter is varied while the rest of the parameters are held at their constant levels. The variables optimized were: flow rate, reagent volume, analyte volume and reaction coil volume.

Reagent and Analyte Flow Rate

The reaction between $\text{Cu}(\text{Nc})_2^{2+}$ and *N*-acetyl-L-cysteine is rapid and results in an immediate reduction of $\text{Cu}(\text{Nc})_2^{2+}$ complex to $\text{Cu}(\text{Nc})_2^+$. The effect of reagent and analyte flow rate was examined in the range of 1.0 to 6.0 mL min⁻¹. Increasing the flow rate the sensitivity was not significantly affected moreover, the number of analysis per unit of time was also increased. At a flow rate of 6.0 mL min⁻¹, repeatable and narrow signals of maximum height were recorded. Consequently further optimization procedure was carried out at optimum reagent and analyte flow rate of 6.0 mL min⁻¹ (Figure 4).

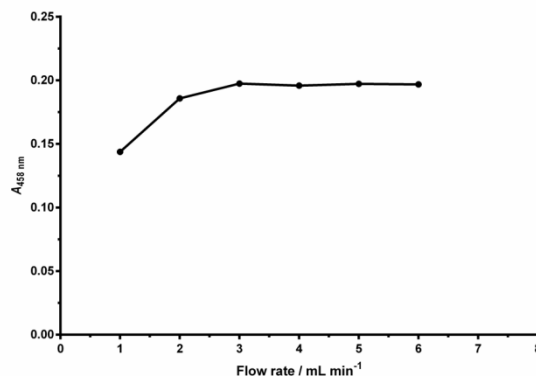

Figure 4. The effect of reagent and analyte flow rate on recorded absorbance Experimental conditions: $c(\text{NAC}) = 4.0 \times 10^{-5}$ mol L⁻¹; $c(\text{Cu}(\text{Nc})_2^{2+}) = 5.0 \times 10^{-4}$ mol L⁻¹; pH = 3.0; $t = 25$ °C; Reagent and analyte flow rate: 1.0 - 6.0 mL min⁻¹; Reaction coil length = 60 cm ($V = 240$ μL); Volume of reagent injected $V(\text{Cu}(\text{Nc})_2^{2+}) = 500$ μL; Volume of *N*-acetyl-L-cysteine injected $V(\text{NAC}) = 500$ μL; Carrier volume $V = 6.0$ mL; Flow cell volume = 80 μL; Wavelength: $\lambda = 458$ nm.

Reagent volume

The influence of reagent volume was examined in the range of 100 to 500 μL in 100 μL increments, while the sample volume was held constant at 500 μL . An increase in signal height was recorded by increasing the reagent volume as shown in Figure 5. Reagent volume of 300 μL ensures the sensitivity of the method and high frequency of measurements, as well as low consumption of the reagent solution, thus, this value was selected as the preferred value for all further measurements.

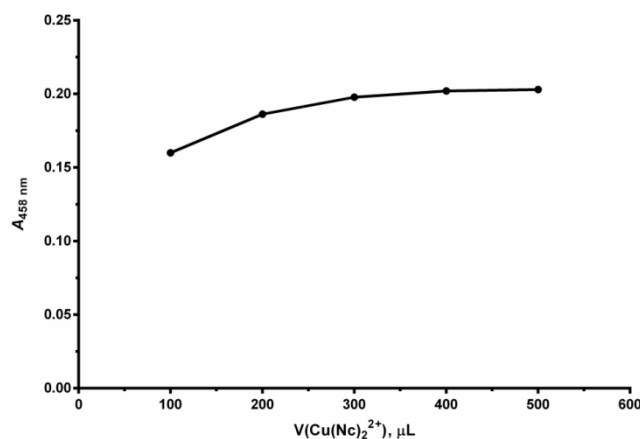

Figure 5. The effect of reagent volume on recorded absorbance. Experimental conditions: $c(\text{NAC}) = 4.0 \times 10^{-5} \text{ mol L}^{-1}$; $c(\text{Cu}(\text{Nc})_2^{2+}) = 5.0 \times 10^{-4} \text{ mol L}^{-1}$; $\text{pH} = 3.0$; $t = 25 \text{ }^\circ\text{C}$; Reagent and analyte flow rate: 6.0 mL min^{-1} ; Reaction coil length = 60 cm ($V = 240 \text{ } \mu\text{L}$); Volume of reagent injected $V(\text{Cu}(\text{Nc})_2^{2+}) = 100 - 500 \text{ } \mu\text{L}$; Volume of *N*-acetyl-L-cysteine injected $V(\text{NAC}) = 500 \text{ } \mu\text{L}$; Carrier volume $V = 6.0 \text{ mL}$; Flow cell volume = 80 μL ; Wavelength: $\lambda = 458 \text{ nm}$.

Analyte volume

The effect of analyte volume on recorded absorbance was studied in the range of 100 to 500 μL , the results are shown in Figure 6. The recorded signals increased with increasing injected sample volume. 300 μL of sample volume was finally chosen for subsequent experiments as it gave good response for lower *N*-acetyl-L-cysteine concentrations. Further increase of sample volume significantly increased return time thus reducing sample throughput, inherently reducing analyte solution consumption.

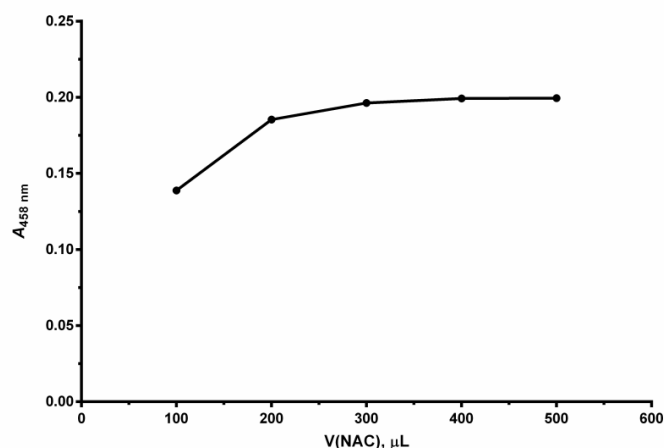

Figure 6. The effect of analyte volume on recorded absorbance. Experimental conditions: $c(\text{NAC}) = 4.0 \times 10^{-5} \text{ mol L}^{-1}$; $c(\text{Cu}(\text{Nc})_2^{2+}) = 5.0 \times 10^{-4} \text{ mol L}^{-1}$; $\text{pH} = 3.0$; $t = 25 \text{ }^\circ\text{C}$; Reagent and analyte flow rate: $6000 \text{ } \mu\text{L min}^{-1}$; Reaction coil length = 60 cm ($V = 240 \text{ } \mu\text{L}$); Volume of reagent injected $V(\text{Cu}(\text{Nc})_2^{2+}) = 300 \text{ } \mu\text{L}$; Volume of *N*-acetyl-L-cysteine injected $V(\text{NAC}) = 100 - 500 \text{ } \mu\text{L}$; Carrier volume $V = 6.0 \text{ mL}$; Flow cell volume = 80 μL ; Wavelength: $\lambda = 458 \text{ nm}$.

Reaction coil

Under the previously optimized parameters, the effect of the length of the reaction coils was examined in the range of 120-500 μL (30-120 cm). By increasing the length of the reaction coil the signal was decreased, confirming, what was previously stated, that the reaction is rapid and the decrease in signal is a consequence of

physical dispersion. The maximum analytical signal was recorded at a reaction coil length of 30 cm (120 μL), which was chosen as an optimum value for further measurements.

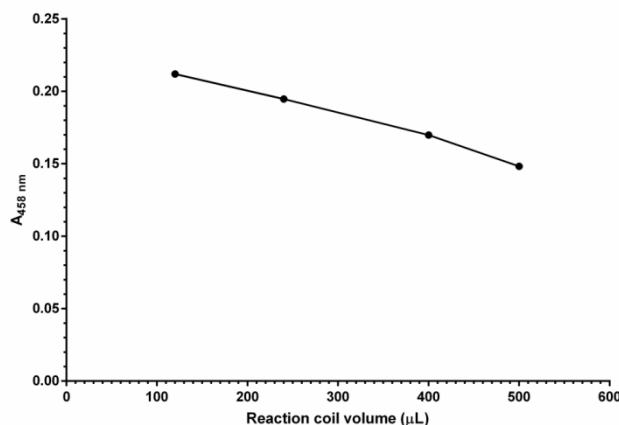

Figure 7. Reaction coil volume. Experimental conditions: $c(\text{NAC}) = 4.0 \times 10^{-5} \text{ mol L}^{-1}$; $c(\text{Cu}(\text{Nc})_2^{2+}) = 5.0 \times 10^{-4} \text{ mol L}^{-1}$; $\text{pH} = 3.0$, $t = 25 \text{ }^\circ\text{C}$; Reagent and analyte flow rate: 6.0 mL min^{-1} ; Reaction coil length = 60 cm ($V = 240 \text{ } \mu\text{L}$); Volume of reagent injected $V(\text{Cu}(\text{Nc})_2^{2+}) = 300 \text{ } \mu\text{L}$; Volume of *N*-acetyl-L-cysteine injected $V(\text{NAC}) = 300 \text{ } \mu\text{L}$; Carrier volume $V = 6.0 \text{ mL}$; Flow cell volume = $80 \text{ } \mu\text{L}$; Wavelength: $\lambda = 458 \text{ nm}$.

Table 2. Optimization of parameters of the developed hybrid flow system

Variable	Studied range	Optimum value
Reagent and analyte flow rate	$1.0 - 6.0 \text{ mL min}^{-1}$	6.0 mL min^{-1}
Reagent volume	$100 - 500 \text{ } \mu\text{L}$	$300 \text{ } \mu\text{L}$
Analyte volume	$100 - 500 \text{ } \mu\text{L}$	$300 \text{ } \mu\text{L}$
Reaction coil volume	$120 - 500 \text{ } \mu\text{L}$	$120 \text{ } \mu\text{L}$

Linearity, precision and repeatability

Using the optimized parameters of the hybrid flow system, the analytical characteristics of the developed method were determined. The calibration curve was constructed in *N*-acetyl-L-cysteine concentration range from 1.0×10^{-6} to $1.0 \times 10^{-4} \text{ mol L}^{-1}$. A linear response of the recorded absorbance in dependence of concentration of *N*-acetyl-L-cysteine obeying the equation: $y = 5203.5x + 0.0062$ was attained. Linear regression analysis showed an excellent correlation coefficient ($R^2 = 0.9994$) for the mentioned series of standard solutions.

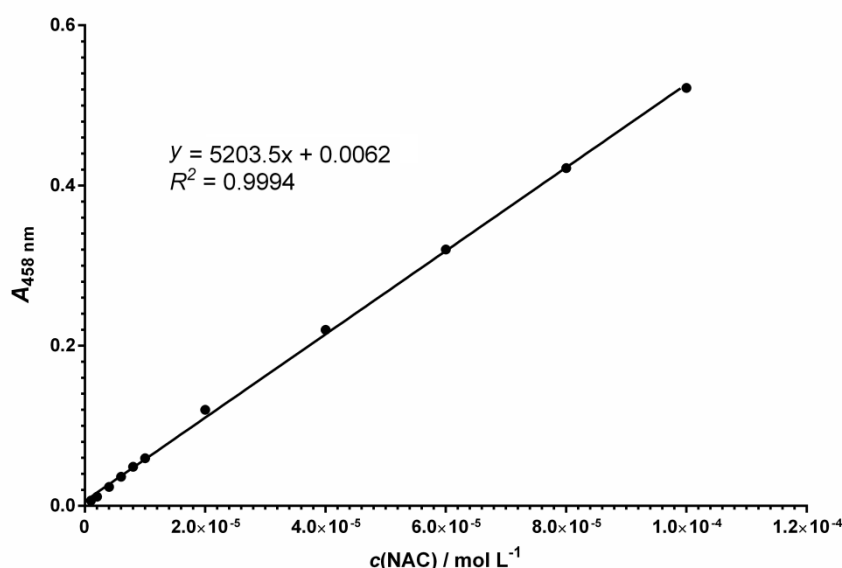

Figure 8. Calibration curve. Experimental conditions: $c(\text{NAC}) = 1.0 \times 10^{-6}$, 2.0×10^{-6} , 4.0×10^{-6} , 6.0×10^{-6} , 8.0×10^{-6} , 1.0×10^{-5} , 2.0×10^{-5} , 4.0×10^{-5} , 6.0×10^{-5} , 8.0×10^{-5} , $1.0 \times 10^{-4} \text{ mol L}^{-1}$; $c(\text{Cu}(\text{Nc})_2^{2+}) = 5.0 \times 10^{-4} \text{ mol L}^{-1}$; $\text{pH} = 3.0$; $t = 25 \text{ }^\circ\text{C}$; Reagent and analyte flow rate: 6.0 mL min^{-1} ; Reaction coil length = 30 cm ($V = 120 \text{ } \mu\text{L}$); Volume of reagent injected $V(\text{Cu}(\text{Nc})_2^{2+}) = 300 \text{ } \mu\text{L}$; Volume of *N*-acetyl-L-cysteine injected $V(\text{NAC}) = 300 \text{ } \mu\text{L}$; Carrier volume $V = 6.0 \text{ mL}$; Flow cell volume = $80 \text{ } \mu\text{L}$; Wavelength: $\lambda = 458 \text{ nm}$.

The limit of detection (LOD) and limit of quantification (LOQ) were calculated and the values were found to be 9.8×10^{-7} mol L⁻¹, and 2.7×10^{-7} mol L⁻¹ respectively. The total analysis time including reagent and sample injection, the formation of the analytical signal and return to baseline was 33 s. Using the optimized chemical and physical parameters, a sampling frequency of 100 determinations per hour was achieved. The baseline remained unchanged throughout the one-hour analysis time. The repeatability of the proposed testing method was examined by conducting ten consecutive injections of *N*-acetyl-L-cysteine. The calculated relative standard deviation was 0.41 %, the result was considered to be satisfactory.

The influence of a foreign ion or substance was determined by testing standard *N*-acetyl-L-cysteine ($c(\text{NAC}) = 4.0 \times 10^{-5}$ mol L⁻¹) solutions with addition of different amounts of foreign substances that can cause an error in the determination of this analyte. The tolerance limit is defined as the concentration of a foreign ion or substance that will cause an error of less than $\pm 5\%$ in the determination of the analyte of interest. At a ratio of 200 times greater than the concentration of *N*-acetyl-L-cysteine, fructose, lactose, sucrose, boric acid, and potassium nitrate showed no significant interference effect. Glucose, tartaric acid, sodium citrate at a ratio of 100 times the concentration of *N*-acetyl-L-cysteine showed no interference.

Analysis of samples

The developed and optimized method of *N*-acetyl-L-cysteine determination using a hybrid flow analysis system with a spectrophotometric detector can be applied for the determination of *N*-acetyl-L-cysteine as an active substance in several commercially available pharmaceutical preparations. A standard iodometric method described by European Pharmacopoeia was taken for comparison.[7] Results presented in Table 3. show a good agreement in *N*-acetyl-L-cysteine values obtained by the standard method and values obtained by the optimized hybrid flow method. These results suggest that the proposed method is accurate and precise.

Table 3. Comparison of results obtained by the proposed method and the standard method

Sample	Labeled amount (mg/tablet)	Proposed method (mg/tablet)	Titrimetry (mg/tablet)[7]
FLUIMUKAN® AKUT JUNIOR	100 mg	98 ± 0.5	103 ± 0.2
FLUIMUKAN® JUNIOR	100 mg	97 ± 0.4	106 ± 0.1
NAXIL forte	600 mg	592 ± 0.2	611 ± 0.3

IV. Conclusion

With the two mentioned optimum values of reagent and sample volume, the consumption of reagent $\text{Cu}(\text{Nc})_2^{2+}$ and sample *N*-acetyl-L-cysteine is very low. The developed hybrid flow injection spectrophotometric method is simple, accurate, reproducible and sensitive. Costs of a similar sequential injection system that would allow low consumption of analyte and reagent solutions would be significantly higher, while a similar flow injection system would require higher consumption of analyte and reagent solutions. The proposed hybrid flow system is characterized by low consumption of analyte and reagent solutions (a characteristic of a sequential injection system) and a large number of analyses per unit time (a characteristic of a flow injection system) with the apparatus being relatively inexpensive and easily attainable. In addition, the developed method is environmentally friendly due to the low consumption of analyte and reagent solution. Finally, it is important to note that the proposed method does not show interference with excipients and additives in pharmaceutical preparations, and is therefore easily applicable for the determination of *N*-acetyl-L-cysteine in commercially available pharmaceutical preparations.

References

- [1]. Aldini G, Altomare A, Baron G, Vistoli G, Carini M, Borsani L, Sergio F. *N*-Acetylcysteine as an antioxidant and disulphide breaking agent: the reasons why. 2018; *Free Radical Research*, 52: 751-762.
- [2]. Amaral EP, Conceição, EL, Costa DL *et al.* *N*-acetyl-cysteine exhibits potent anti-mycobacterial activity in addition to its known anti-oxidative functions. 2016; *BMC Microbiol* 16, 251.
- [3]. Samuni Y, Goldstein S, Dean OM, Berk M. The chemistry and biological activities of *N*-acetylcysteine. 2013; *Biochimica et Biophysica Acta* 1830 4117–4129.
- [4]. Heard KJ. Acetylcysteine for Acetaminophen Poisoning. 2008; *The New England Journal of Medicine*, 359: 285-92.
- [5]. Pei Y, Liu H, Yang Y, Yang Y, Jiao Y, Tay FR, Chen J, Biological Activities and Potential Oral Applications of *N*-Acetylcysteine: Progress and Prospects. 2018; *Oxid Med Cell Longev*. Volume 2018, Article ID 2835787, 14 pages.
- [6]. Radtke KK, Coles LD, Mishra U, Orchard PJ, Holmay M, Cloyd James C. Interaction of *N*-acetylcysteine and Cysteine in Human Plasma. 2012; *Journal of Pharmaceutical Sciences* Volume 101, Issue 12, Pages 4653–4659.
- [7]. European Pharmacopoeia, Convention on the Elaboration of a European Pharmacopoeia, 5th ed, 2005, p. 915-917.
- [8]. Rizk MS, Belal FM, Eid M. 2-Iodoxybenzoate as a titrant for the determination of some pharmaceutically-important thiol compounds. *Acta Pharmaceutica Hungarica*. 1993; 63: 13–18.
- [9]. Al-Ghannam Sh M, El-Brashy AM, Al-Farhan BS. Fluorimetric determination of some thiol compounds in their dosage forms. *Farmaco* 2002; 57 625–629.

- [10]. Toussaint B, Pitti C, Strel B, Ceccato A, Hubert P, Crommen J. Quantitative analysis of N-acetylcysteine and its pharmacopeial impurities in a pharmaceutical formulation by liquid chromatography-UV detection-mass spectrometry. *Journal of Chromatography A*, 2000; 896: 191–199.
- [11]. Dobcnik KM. Chemically prepared silver electrode for determination of N-acetyl-L-cysteine by flow-injection potentiometry. *Pharmazie* 2003; 58: 25–28.
- [12]. Janegitz BC, Suarez WT, Fatibello-Filho O, Marcolino-Junior LH. Conductometric Determination of N-acetylcysteine in Pharmaceutical Formulations Using Copper(II) Sulphate as Titrant. *Analytical Letters*, 2008; 41: 3264-3271.
- [13]. Barusa C, Grosa P, Comtata M, Daunes-Marion S, Tarroux R. Electrochemical behaviour of N-acetyl-L-cysteine on 2007; 52: 7978-7985.
- [14]. Buhl F, Galkowska M. Spectrophotometric determination of N-acetyl-L-cysteine using leucoxylenecyanol FF. *Chem. Anal.-Warsaw*, 2006; 51: 623–629.
- [15]. Suarez, WT, Madi AA, Vicentini FC, Fatibello-Filho O. Flow-injection spectrophotometric determination of N-acetylcysteine in pharmaceutical formulations with on-line solid-phase reactor containing Zn(II) phosphate immobilized in a polyester resin. 2007; *Analytical Letters*, 40: 17–29.
- [16]. Suarez WT, Pessoa-Neto OD, Janegitz BC, Vieira HJ, Faria RC, Fatibello-Filho O. Flow injection spectrophotometric determination of N-acetylcysteine and captopril employing Prussian blue generation reaction. 2011; *Analytical Letters* 44: 394–405.
- [17]. Tzanavaras PD. Automated Determination of Pharmaceutically and Biologically Active Thiols by Sequential Injection Analysis: A Review. 2010; *The Open Chemical and Biomedical Methods Journal*, 3, 37-45.
- [18]. Tzanavaras PD, Zacharis CK, Themelis DG, On-Line Derivatization of N-Acetylcysteine Using Ethyl-Propiolate as a Novel Advantageous Reagent and Sequential Injection Analysis. 2010; *Analytical Letters*, 43: 1889–1901.
- [19]. Tabbi G, Giuffrida A, Bonomo RP. Determination of formal redox potentials in aqueous solution of copper(II) complexes with ligands having nitrogen and oxygen donor atoms and comparison with their EPR and UV–Vis spectral features. 2013; *Journal of Inorganic Biochemistry*, 128: 137–145.
- [20]. Besada A, Tadros NB, Gawargious YA, Copper(II)-Neocuproine as Colour Reagent for Some Biologically Active Thiols: Spectrophotometric Determination of Cysteine, Penicillamine, Glutathione, and 6-Mercaptopurine. 1989; *Mikrochim. Acta* III, 143-146.

Kraljević T, et. al. "Spectrophotometric Hybrid Flow System for Determination of N-Acetyl-L-Cysteine in Pharmaceuticals." *IOSR Journal of Applied Chemistry (IOSR-JAC)* 13(5), (2020): 27-34.